

US00D523015S

(12) **United States Design Patent**  
**Loftus**

(10) **Patent No.:** **US D523,015 S**  
(45) **Date of Patent:** **\*\* Jun. 13, 2006**

(54) **THUMBDRIVE**

(75) Inventor: **John Loftus**, Laguna Beach, CA (US)

(73) Assignee: **Memorex International, Inc.**, Kowloon (HK)

(\*\*) Term: **14 Years**

(21) Appl. No.: **29/199,404**

(22) Filed: **Feb. 13, 2004**

(51) **LOC (8) Cl.** ..... **14-02**

(52) **U.S. Cl.** ..... **D14/435**

(58) **Field of Classification Search** ..... D14/218,  
D14/356, 358, 367, 384, 385, 402, 433, 435;  
D13/168; 439/147, 165, 497, 607, 639; 365/200;  
361/737, 752

See application file for complete search history.

(56) **References Cited**

U.S. PATENT DOCUMENTS

D379,009 S	*	4/1997	Osiecki	.....	D14/167
D379,456 S	*	5/1997	Osiecki	.....	D14/167
D463,426 S	*	9/2002	Cheng	.....	D14/356
6,456,500 B1	*	9/2002	Chen	.....	361/752
D465,781 S	*	11/2002	Fischer	.....	D14/240
D470,499 S	*	2/2003	Salazar et al.	.....	D14/436
D482,694 S	*	11/2003	Chen	.....	D14/433
D486,137 S	*	2/2004	Chen	.....	D14/168
2003/0223286 A1	*	12/2003	Lee	.....	365/200

FOREIGN PATENT DOCUMENTS

JP 2003282178 A \* 10/2003

OTHER PUBLICATIONS

Oct. 5, 2005—[http://www.memorexthumbdrive.com/idx\\_educate.htm](http://www.memorexthumbdrive.com/idx_educate.htm)—published: Nov. 18, 2003.\*

Oct. 5, 2005—<http://www.webcorpfx.com/v2-html/Use-Images/reflective/Anthem-mp3-player.jpg>—published: Jul. 26, 2003.\*

\* cited by examiner

*Primary Examiner*—Robin Webster

*Assistant Examiner*—Karen E. Patterson

(74) *Attorney, Agent, or Firm*—Heller Ehrman LLP

(57) **CLAIM**

The ornamental design for a thumbdrive, as shown and described.

**DESCRIPTION**

FIG. 1 is a top, front, and right perspective view of the first embodiment of a thumbdrive, showing our new design;

FIG. 2 is a top view thereof;

FIG. 3 is a bottom view thereof;

FIG. 4 is a right side view thereof;

FIG. 5 is a left side view thereof;

FIG. 6 is a back view thereof; and

FIG. 7 is a front view thereof.

FIG. 8 is a top view of the second embodiment of a thumbdrive;

FIG. 9 is a left side view thereof;

FIG. 10 is a back view thereof; and

FIG. 11 is a front view thereof.

FIG. 12 is a top view of the third embodiment of a thumbdrive;

FIG. 13 is a right side view thereof;

FIG. 14 is a back view thereof; and,

FIG. 15 is a front view thereof.

**1 Claim, 4 Drawing Sheets**

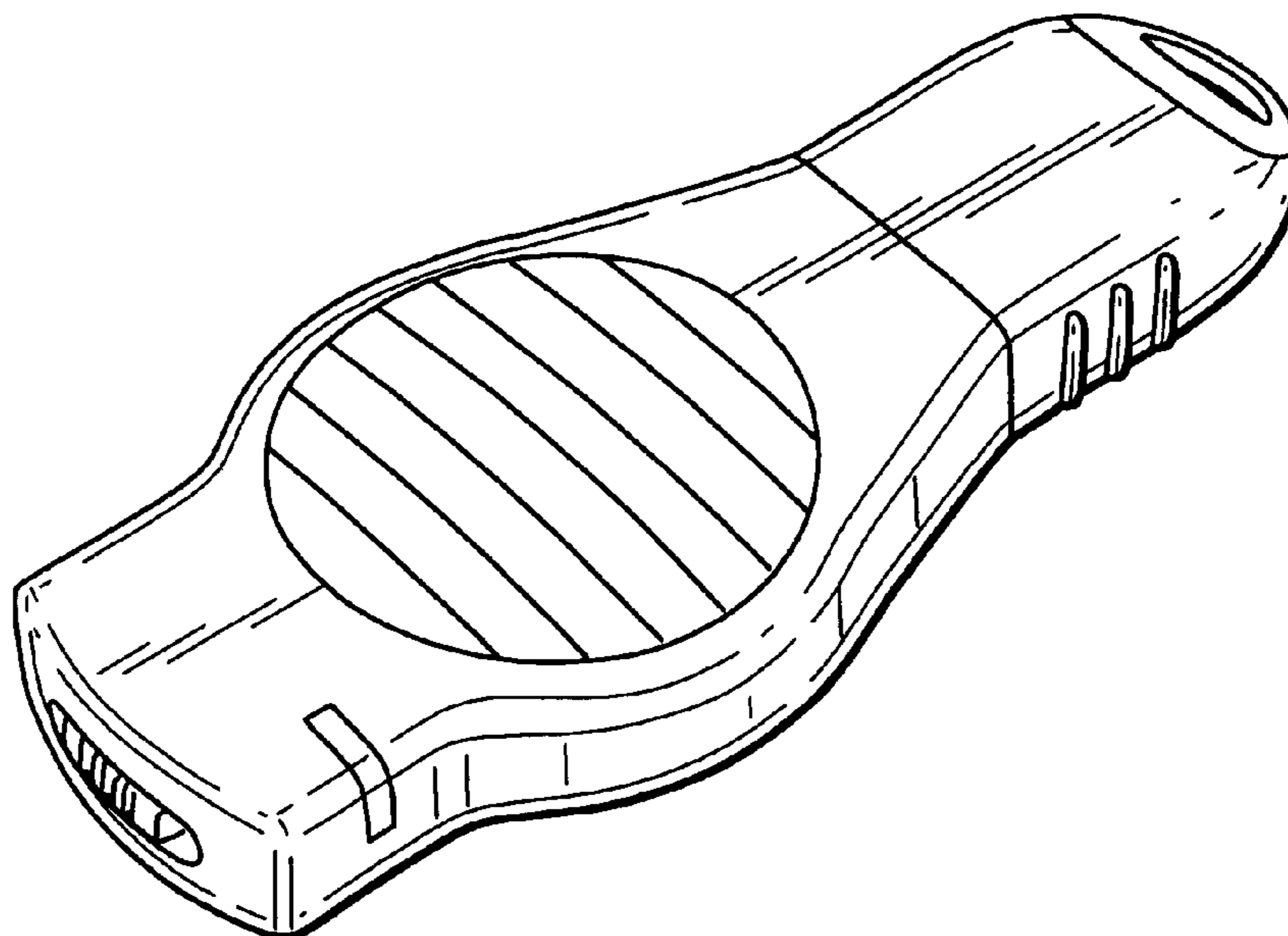

**FIG. 1**

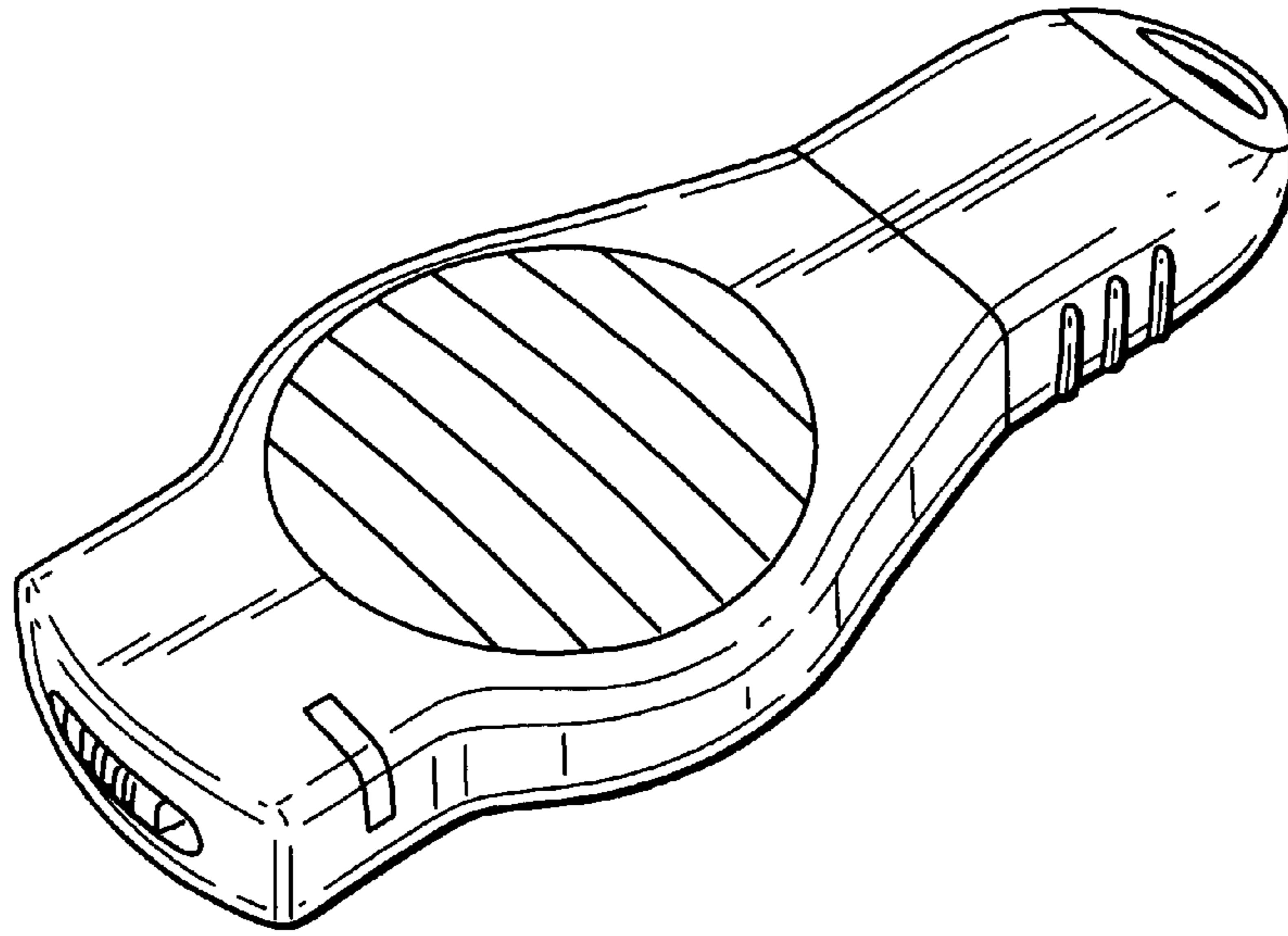

**FIG. 2**

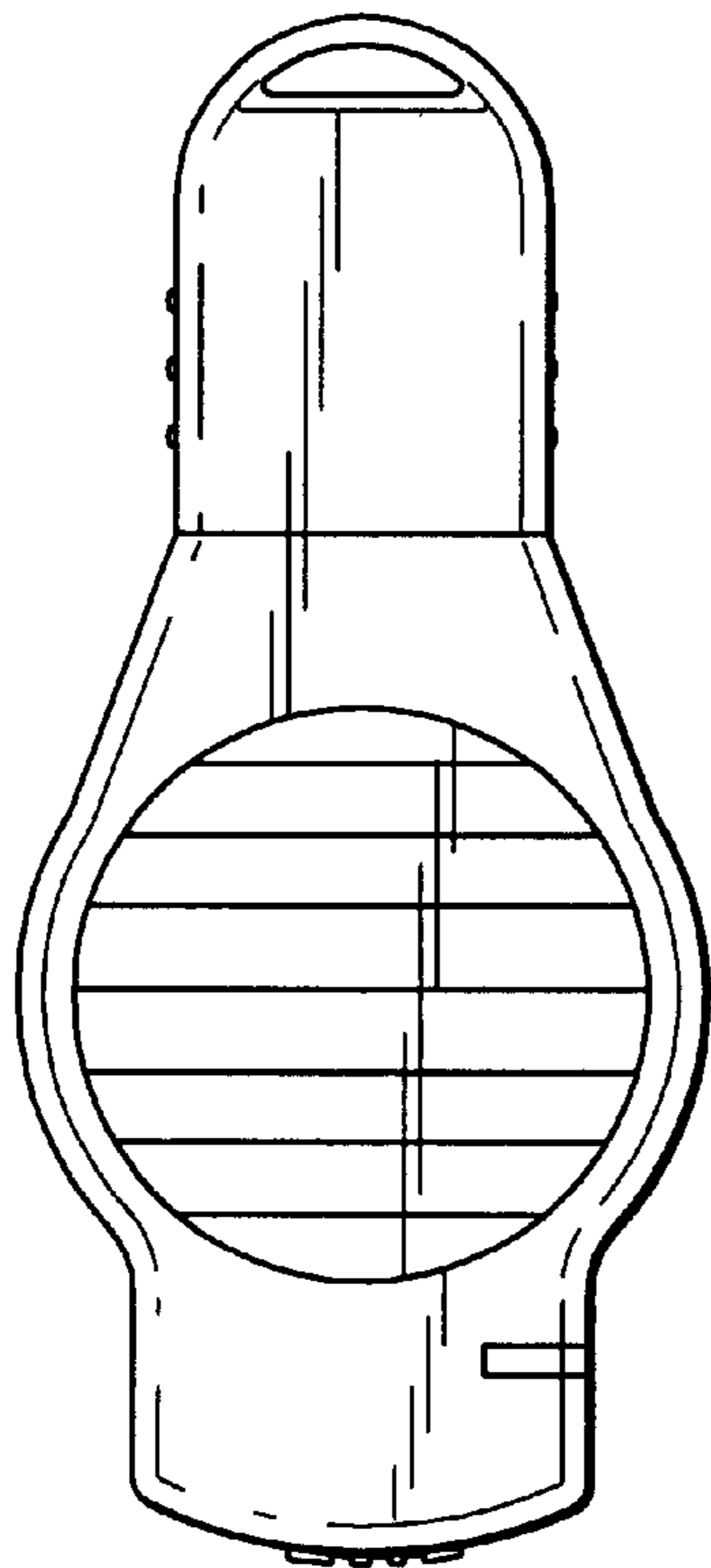

**FIG. 3**

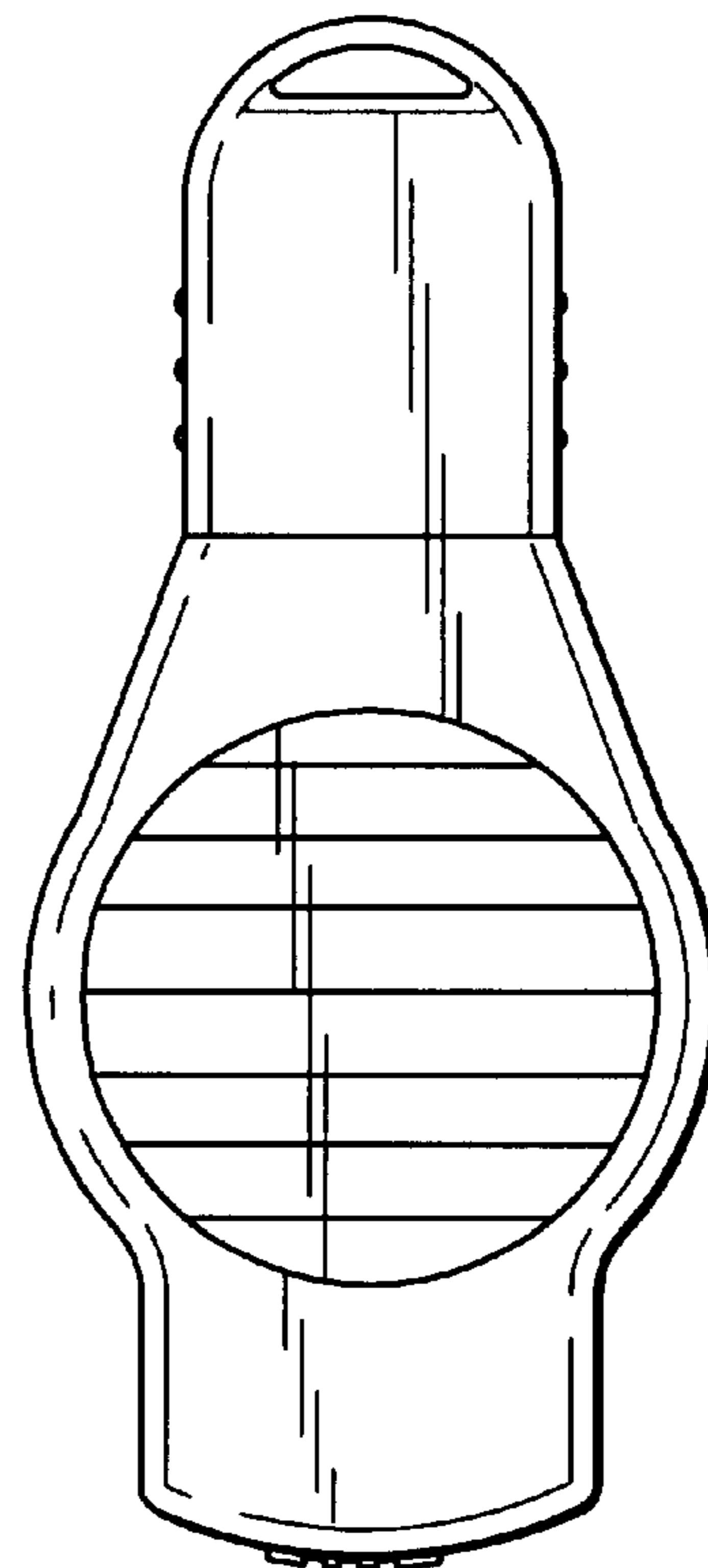

**FIG. 4**



**FIG. 5**

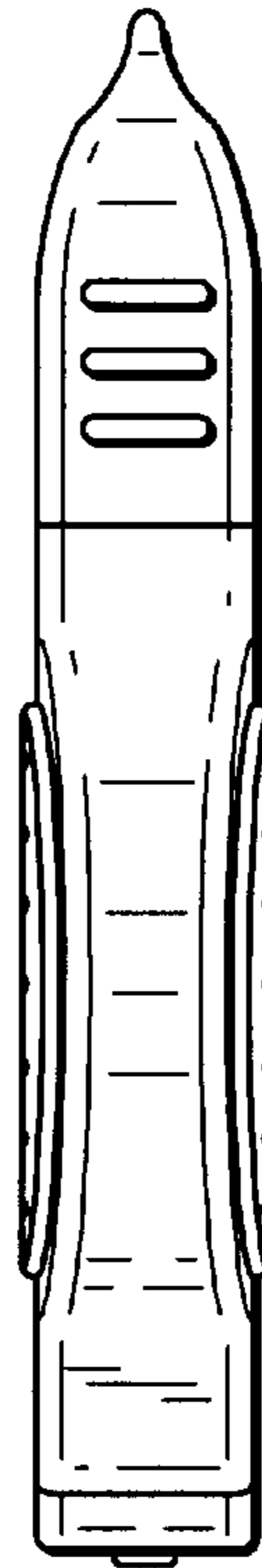

**FIG. 6**

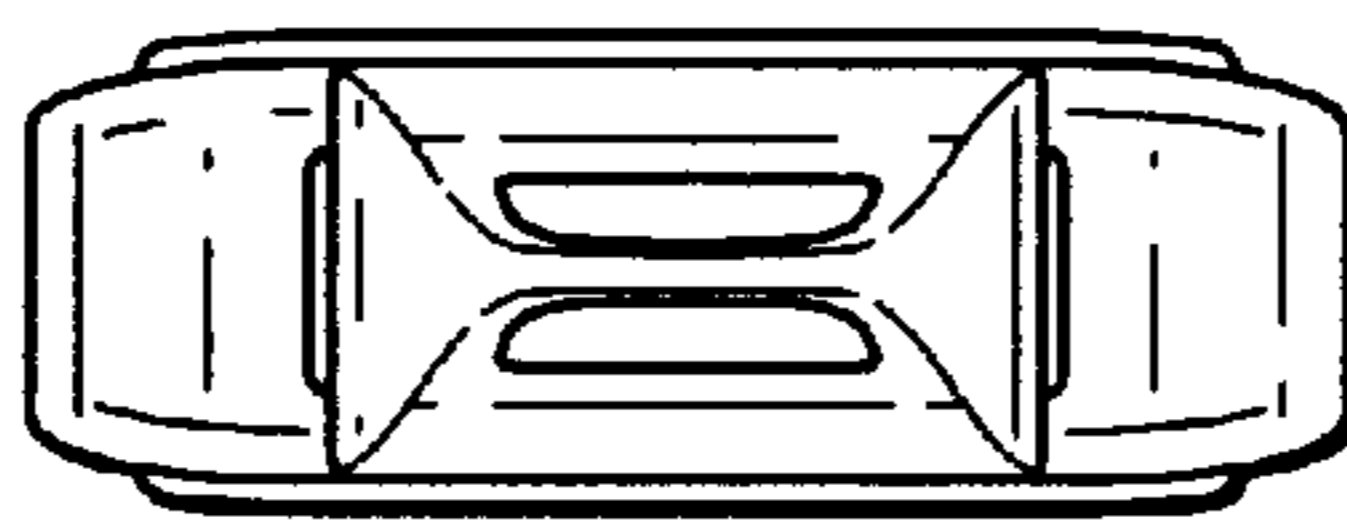

**FIG. 7**

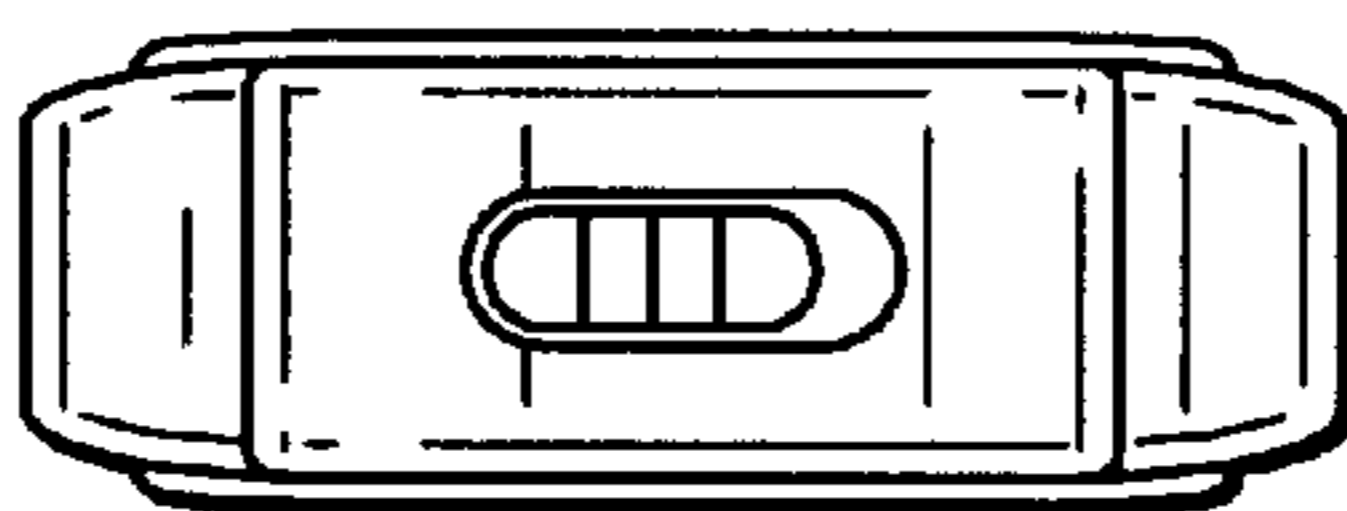

**FIG. 8**

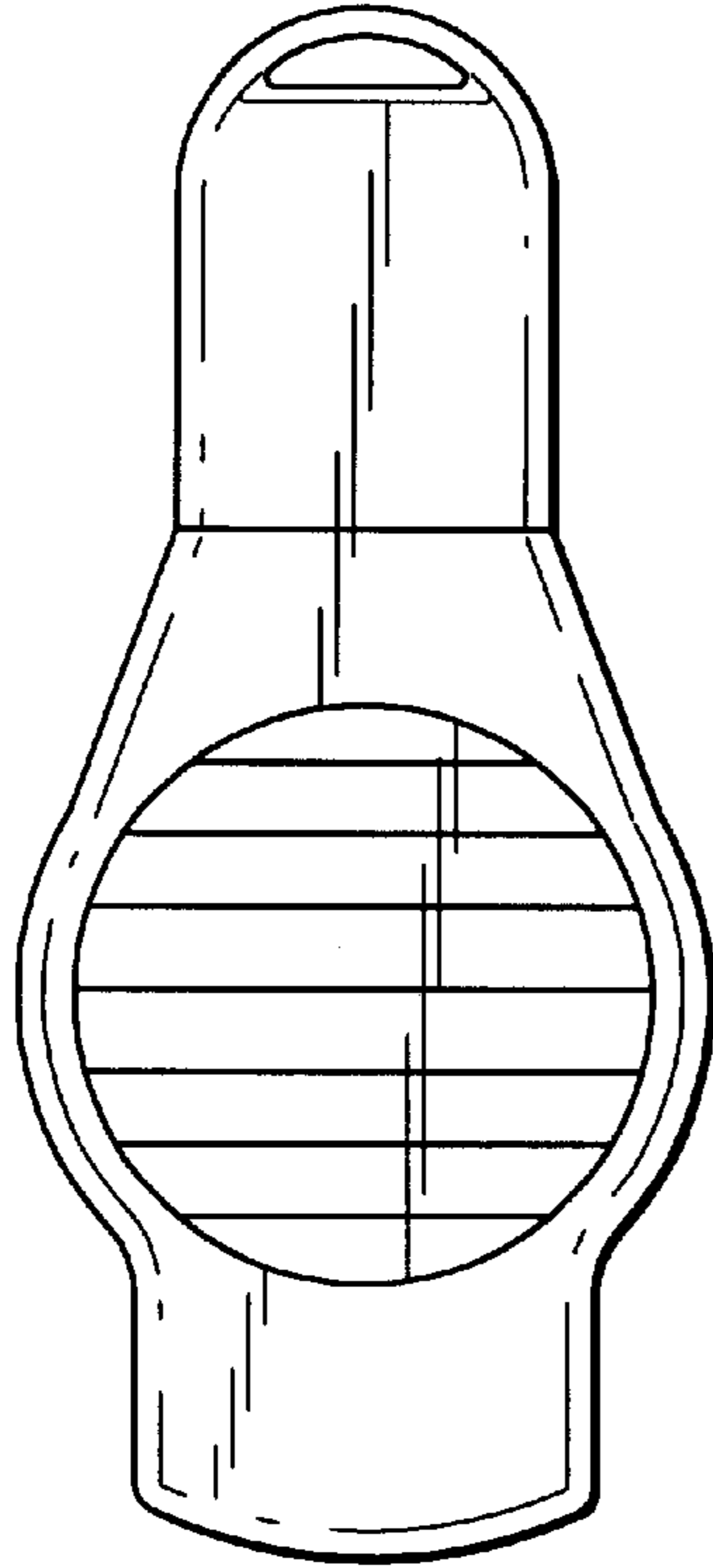

**FIG. 9**



**FIG. 10**

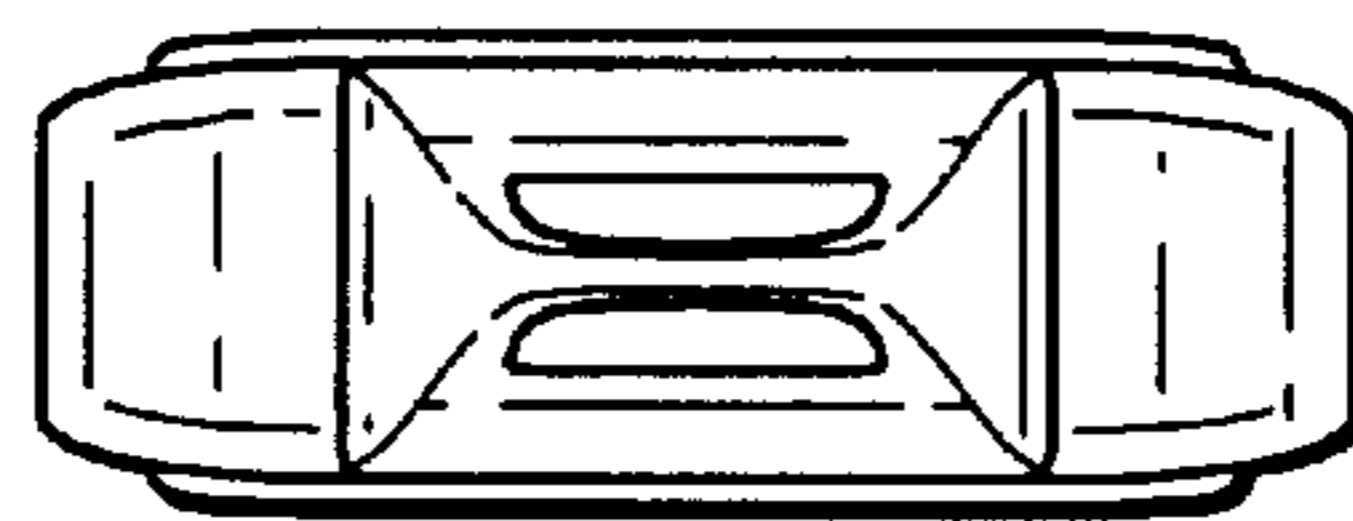

**FIG. 11**



**FIG. 12**

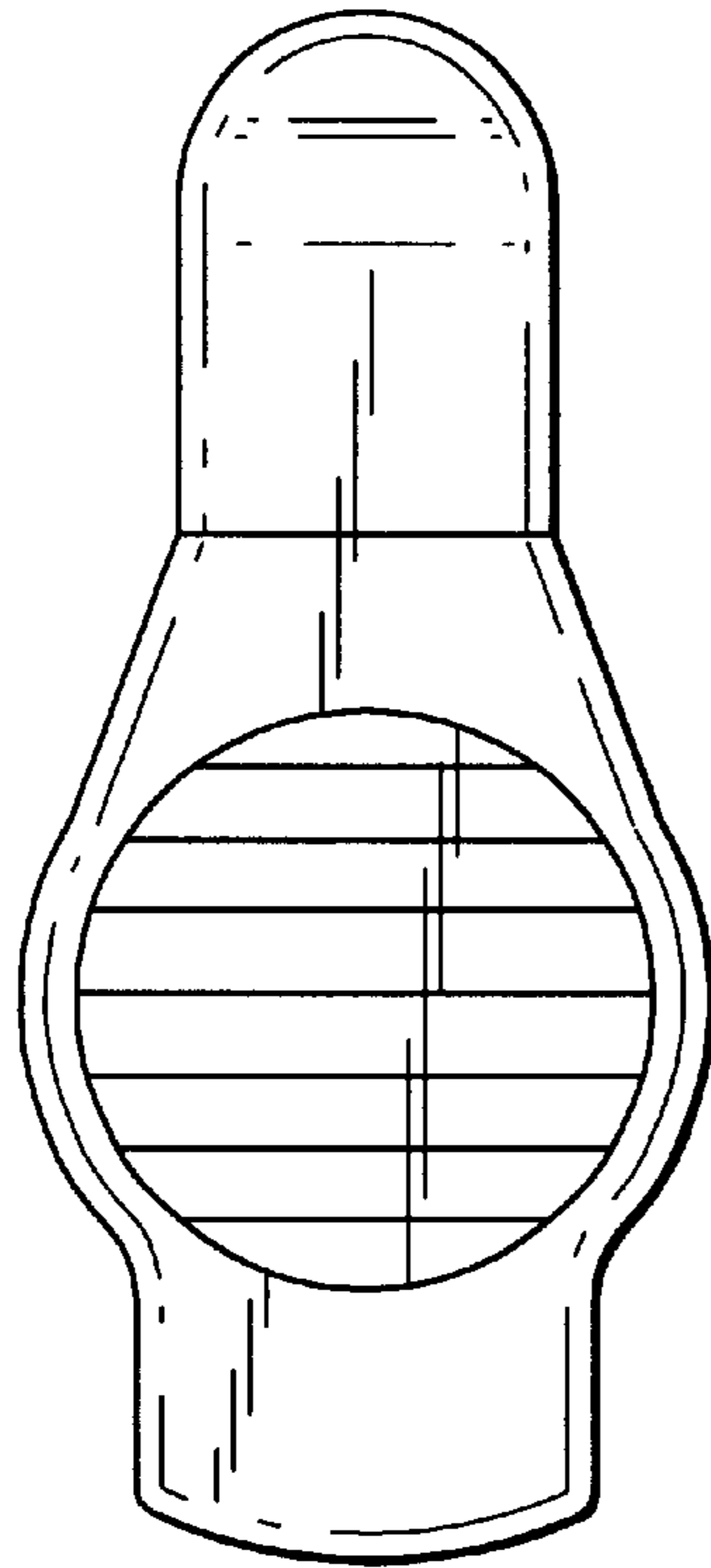

**FIG. 13**

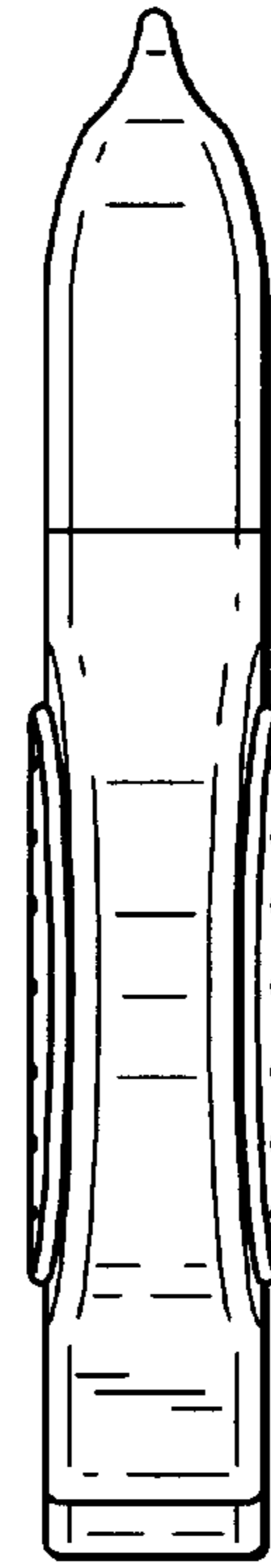

**FIG. 14**

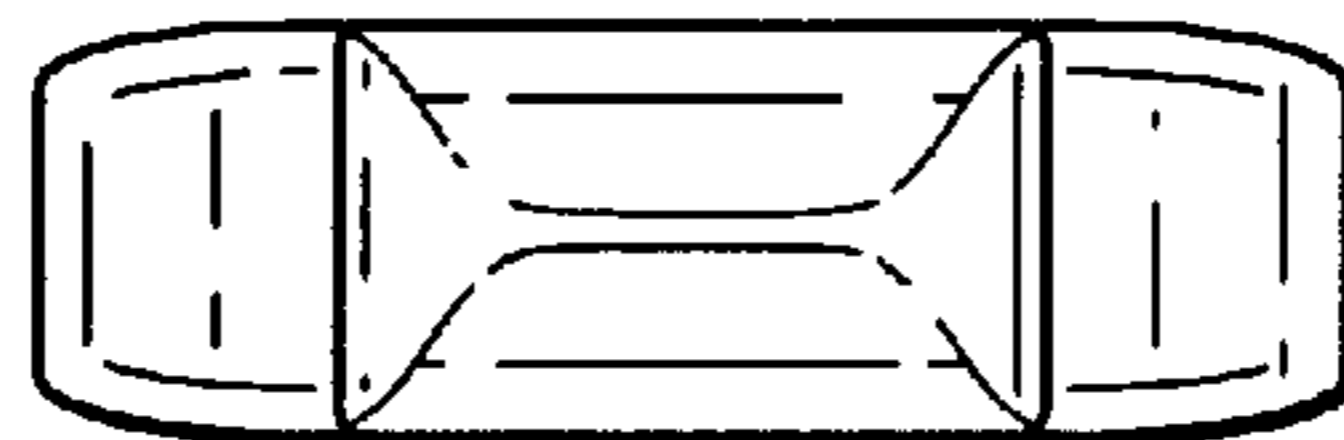

**FIG. 15**

