



US00D522983S

(12) **United States Design Patent**
Lin

(10) **Patent No.:** **US D522,983 S**
(45) **Date of Patent:** **** Jun. 13, 2006**

(54) **TELEVISION SET**

(75) Inventor: **Roger Lin**, Taipei (TW)

(73) Assignee: **Hannspree, Inc.**, Taipei (TW)

(**) Term: **14 Years**

(21) Appl. No.: **29/230,644**

(22) Filed: **May 25, 2005**

(30) **Foreign Application Priority Data**

Dec. 10, 2004 (TW) 93307558

(51) **LOC (8) Cl.** **14-03**

(52) **U.S. Cl.** **D14/126**

(58) **Field of Classification Search** D14/125-134,
D14/239, 371, 136, 374-377; 312/7.2; 348/836,
348/838, 180, 184, 325, 739; 341/12; 248/917-924,
248/465; 345/104, 133, 156, 168, 87, 173;
720/605, 669, 600, 655; 369/99, 197; 455/344-347
See application file for complete search history.

(56) **References Cited**

U.S. PATENT DOCUMENTS

D421,601 S * 3/2000 Chou D14/375
D425,571 S * 5/2000 Goto D21/329
D470,490 S * 2/2003 Lin D14/375

D481,728 S * 11/2003 Olson et al. D14/375
D483,759 S * 12/2003 Sun D14/375
D490,117 S * 5/2004 Butcher D21/329
D496,660 S * 9/2004 Liu D14/371

OTHER PUBLICATIONS

The International Design Magazine, p. 228, Jul./Aug., 1999.*

* cited by examiner

Primary Examiner—Raphael Barkai

(74) *Attorney, Agent, or Firm*—Troxell Law Office, PLLC

(57) **CLAIM**

The ornamental design for a television set, as shown and described.

DESCRIPTION

FIG. 1 is a perspective view of television set showing our design;

FIG. 2 is a front view thereof;

FIG. 3 is a rear side view thereof;

FIG. 4 is a top side view thereof;

FIG. 5 is a bottom side view thereof;

FIG. 6 is a left view thereof; and,

FIG. 7 is a right view thereof.

1 Claim, 4 Drawing Sheets

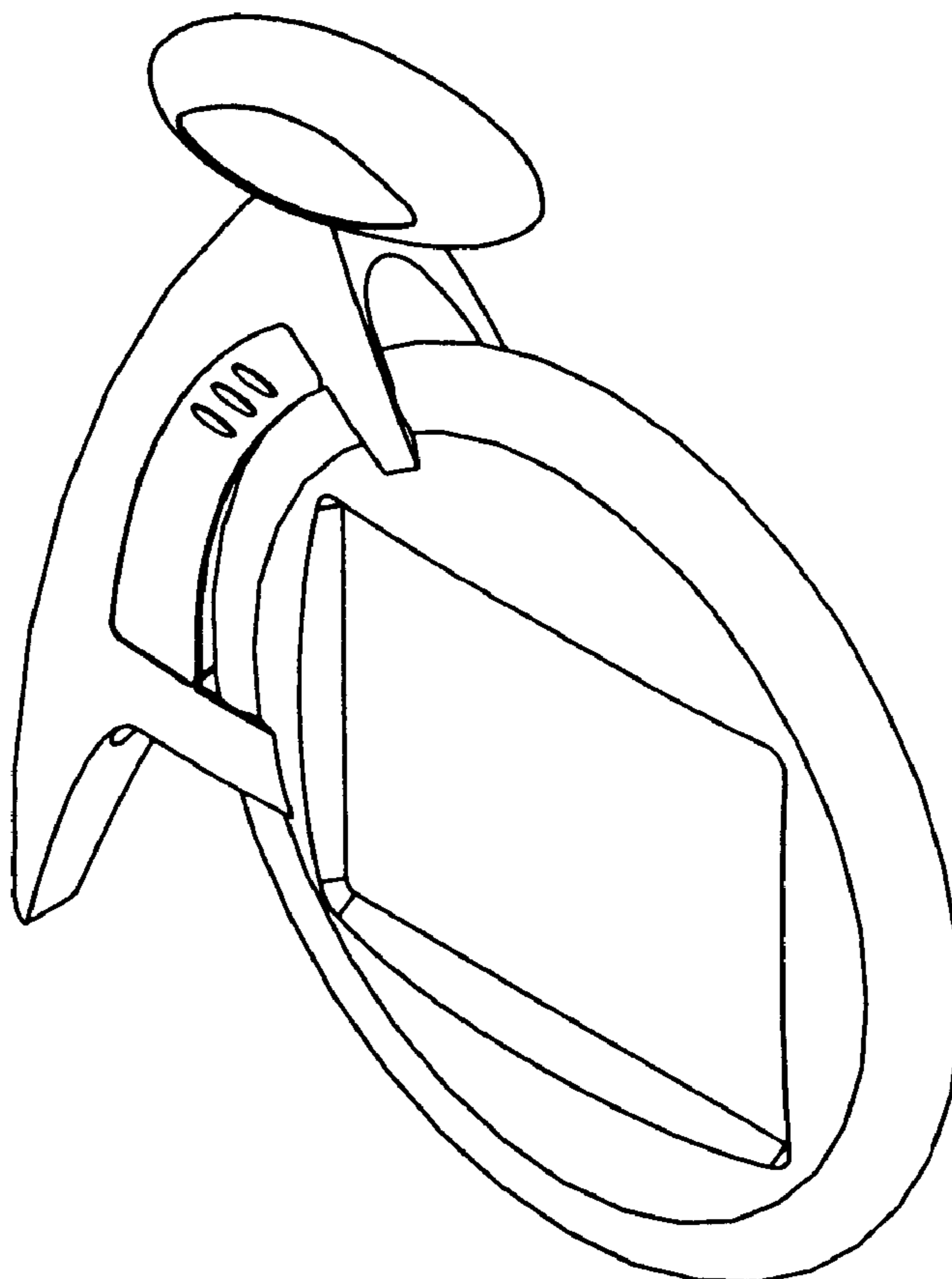

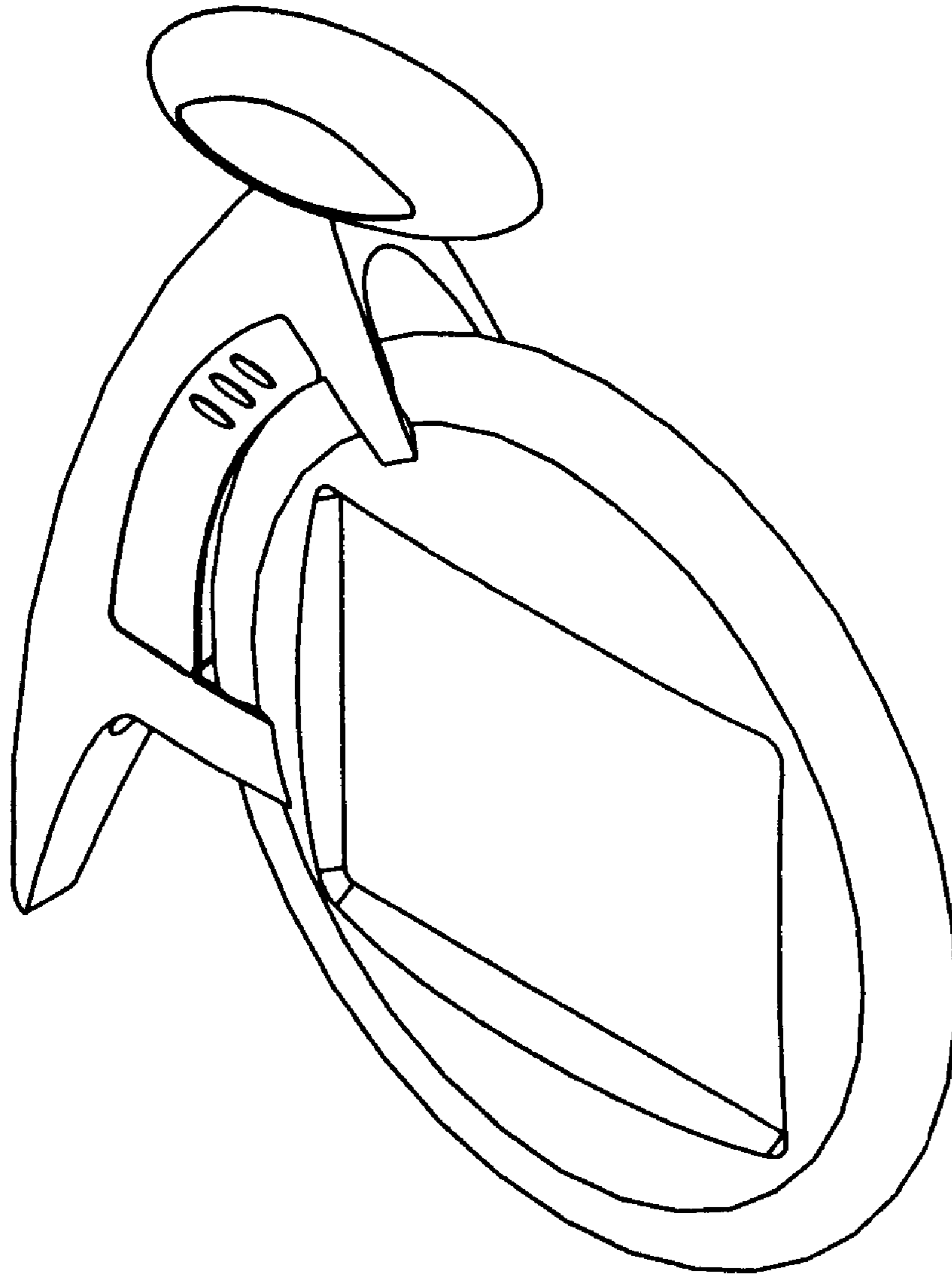

FIG. 1

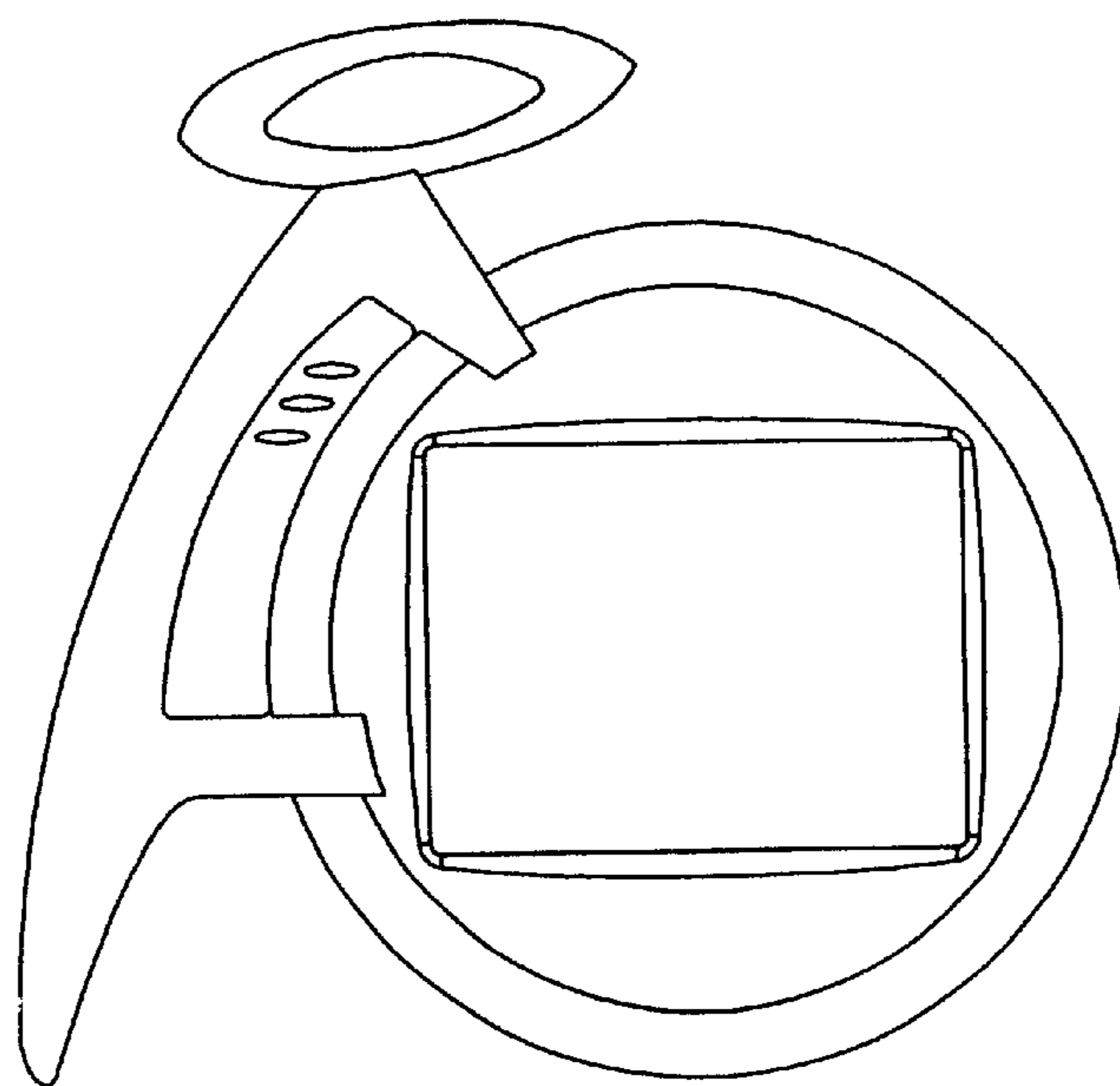

FIG. 2

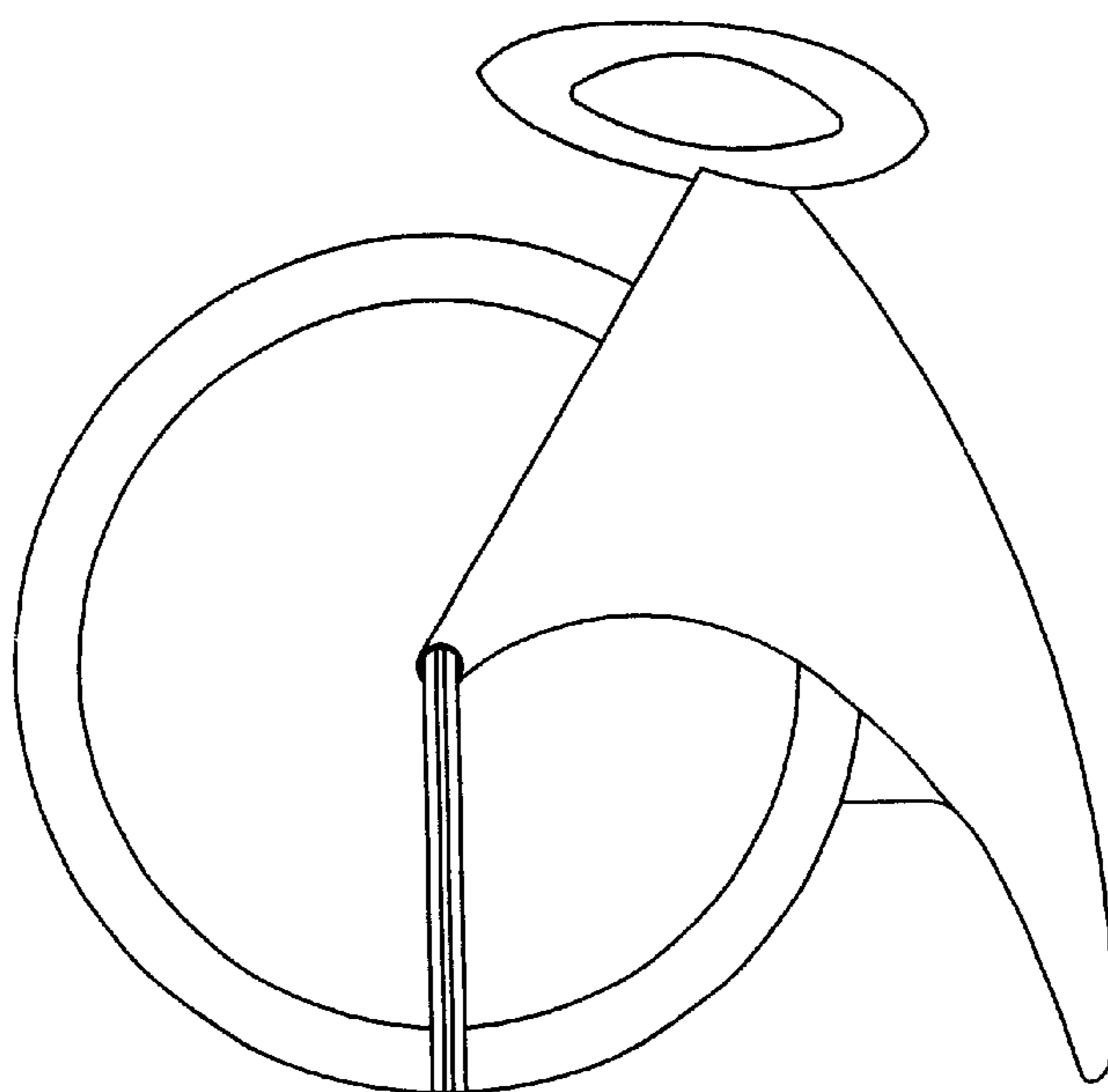

FIG. 3

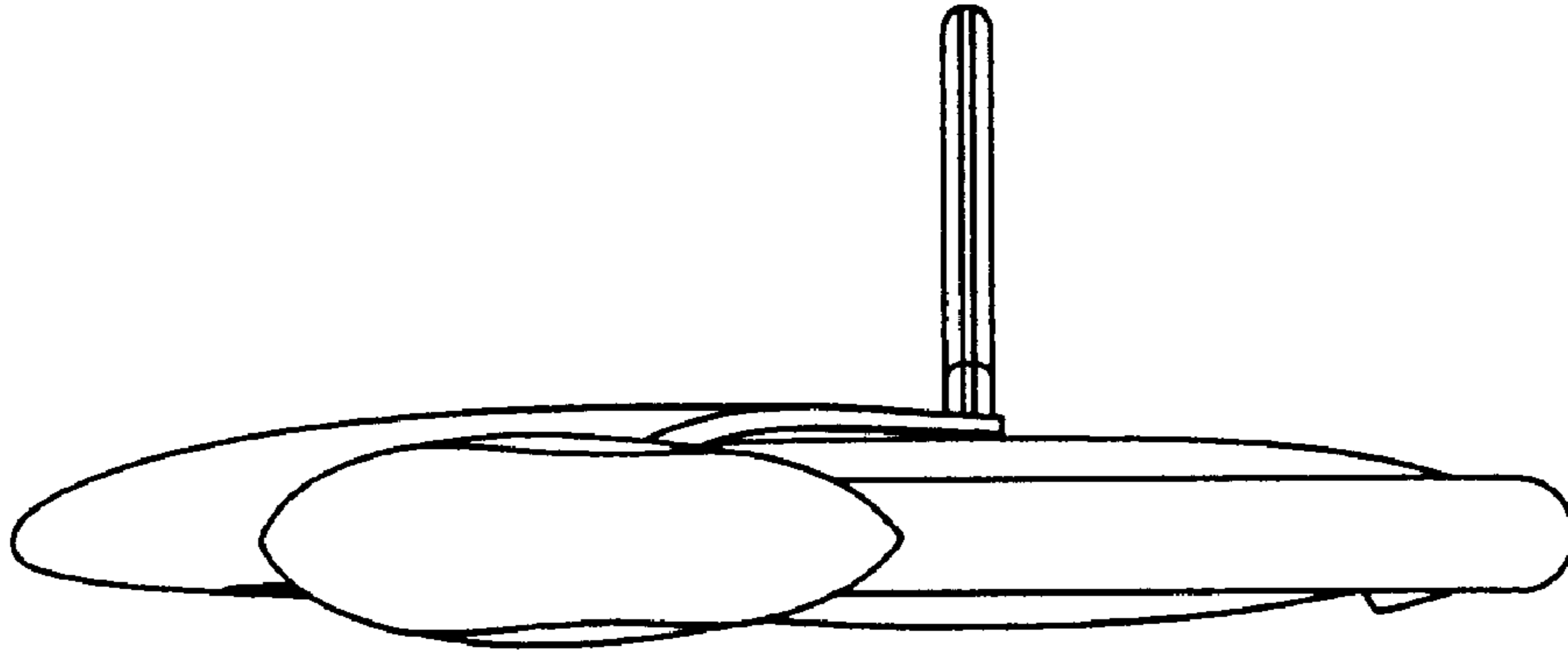

FIG. 4

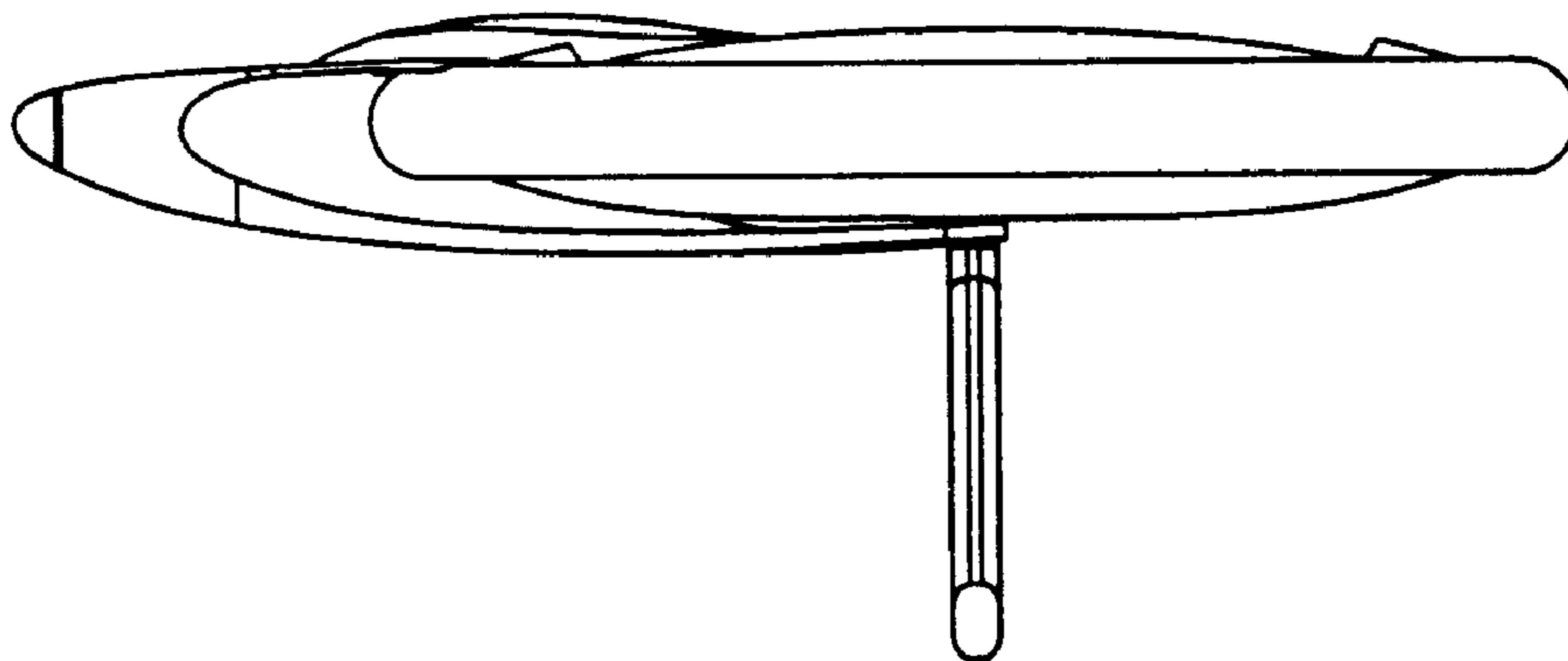

FIG. 5

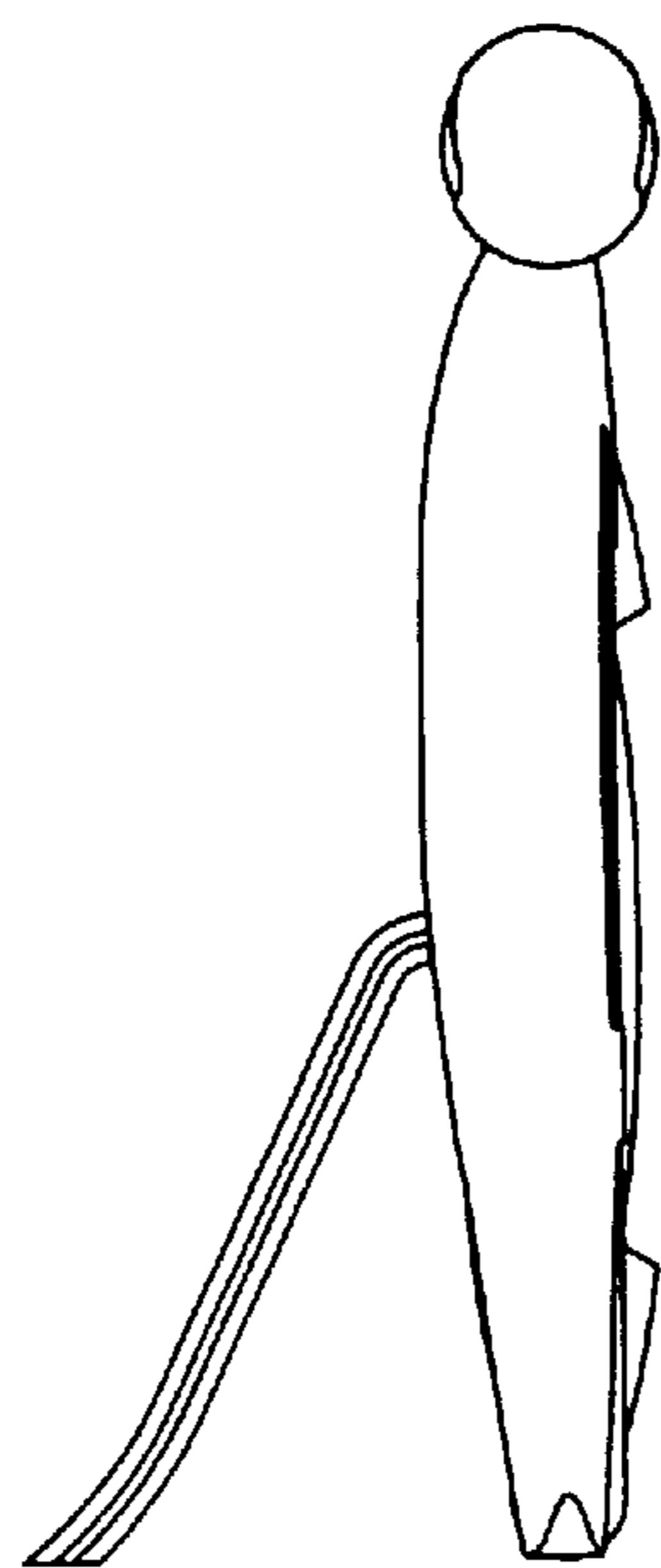

FIG. 6

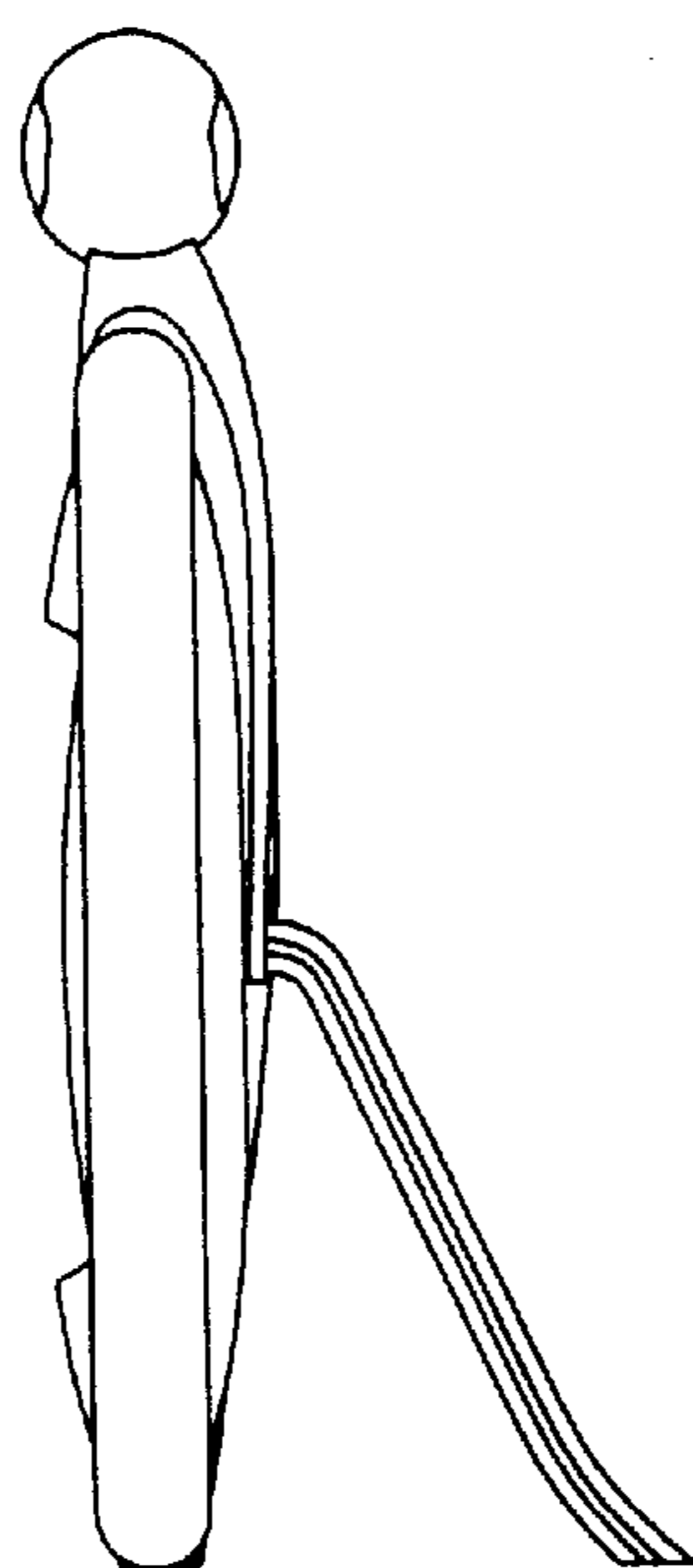

FIG. 7