

US00D522977S

(12) **United States Design Patent**  
**Sato**

(10) **Patent No.:** **US D522,977 S**  
(45) **Date of Patent:** **\*\* Jun. 13, 2006**

(54) **SOCKET FOR SEMICONDUCTOR DEVICE**

(75) Inventor: **Masaru Sato**, Tokyo (JP)

(73) Assignee: **Yamaichi Electronics Co., Ltd.**, Tokyo (JP)

(\*\*) Term: **14 Years**

(21) Appl. No.: **29/219,283**

(22) Filed: **Dec. 16, 2004**

(30) **Foreign Application Priority Data**

Aug. 31, 2004 (JP) ..... 2004-026183

(51) **LOC (8) Cl.** ..... **13-03**

(52) **U.S. Cl.** ..... **D13/182**

(58) **Field of Classification Search** ..... D13/182;  
174/52.1; 324/755; 361/796; 438/106; 439/73,  
439/266, 268

See application file for complete search history.

(56) **References Cited**

**U.S. PATENT DOCUMENTS**

- D395,423 S \* 6/1998 Koyama et al. .... D13/182
- 2003/0032322 A1 \* 2/2003 Nakamura et al. .... 439/330
- 2004/0063241 A1 \* 4/2004 Nakano et al. .... 438/106
- 2004/0212382 A1 \* 10/2004 Cram ..... 324/755
- 2004/0248435 A1 \* 12/2004 Sato et al. .... 439/73

- 2005/0136721 A1 \* 6/2005 Sato ..... 439/266
- 2005/0231919 A1 \* 10/2005 Ujike et al. .... 361/719
- 2005/0250363 A1 \* 11/2005 Suzuki et al. .... 439/266

\* cited by examiner

*Primary Examiner*—Stella Reid

*Assistant Examiner*—Selina Sikder

(74) *Attorney, Agent, or Firm*—Finnegan, Henderson, Farabow, Garrett & Dunner, LLP

(57) **CLAIM**

The ornamental design for a socket for semiconductor device, as shown and described.

**DESCRIPTION**

FIG. 1 is a left-perspective view of a socket for semiconductor device showing my new design;  
 FIG. 2 is a front elevational view of my new design, the rear elevational view being a mirror image thereof;  
 FIG. 3 is a top plan view of my new design;  
 FIG. 4 is a bottom plan view of my new design;  
 FIG. 5 is a right-side view of my new design, the left-side view being a mirror image thereof;  
 FIG. 6 a bottom plan view of my new design with the cross section indicated at 7—7; and,  
 FIG. 7 is a cross sectional view of my new design taken along line 7—7 in FIG. 6.

**1 Claim, 4 Drawing Sheets**

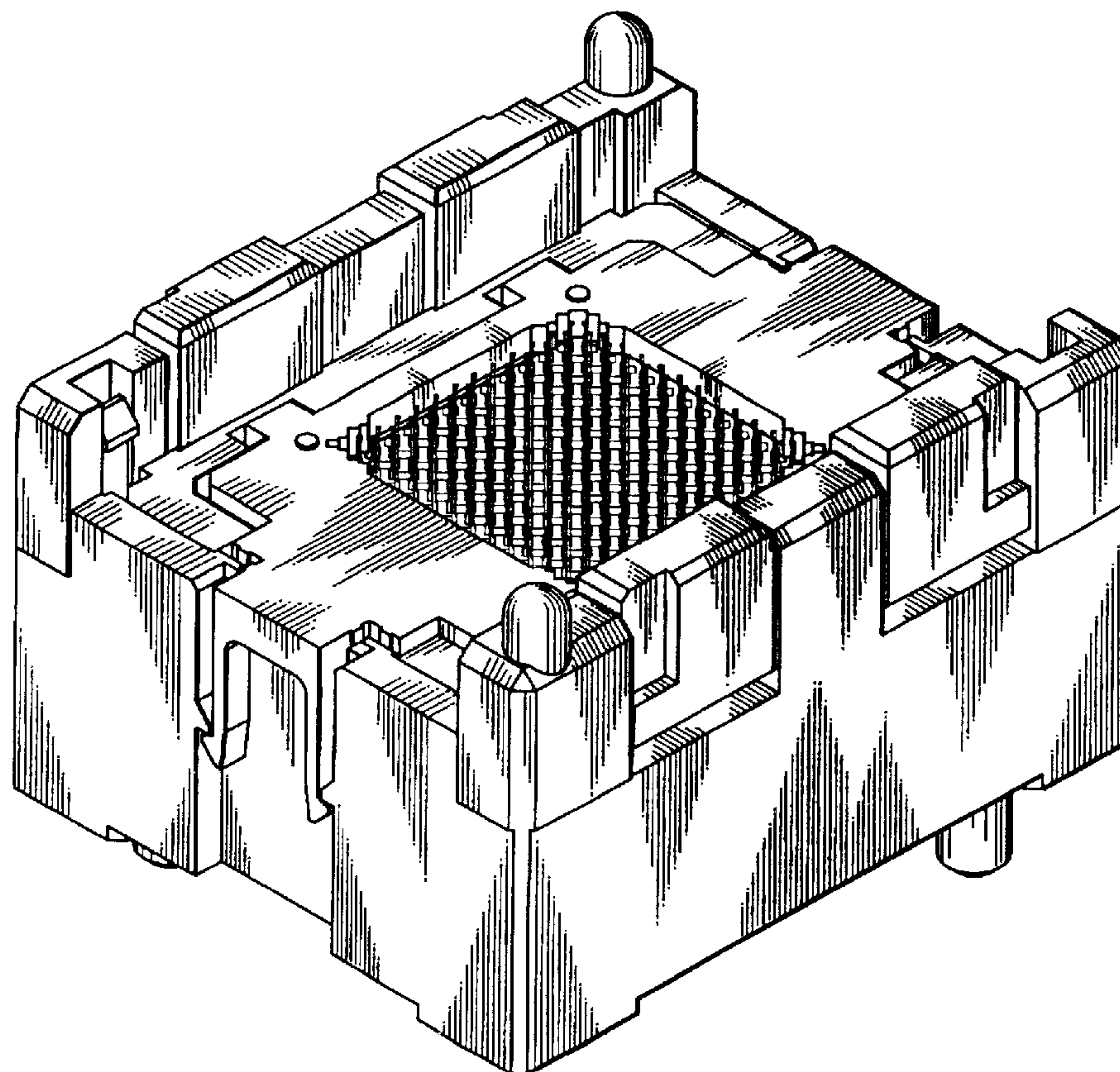
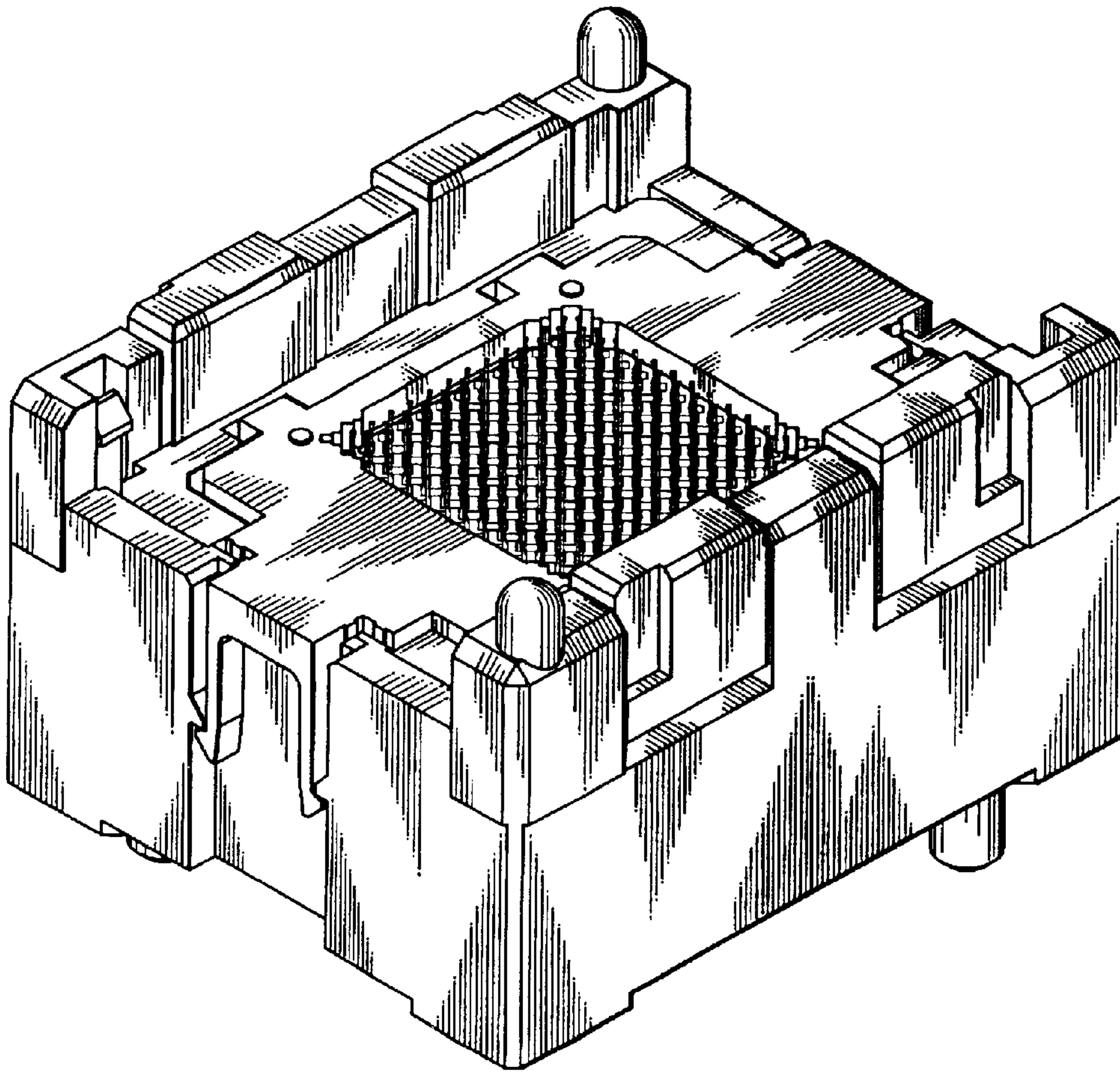
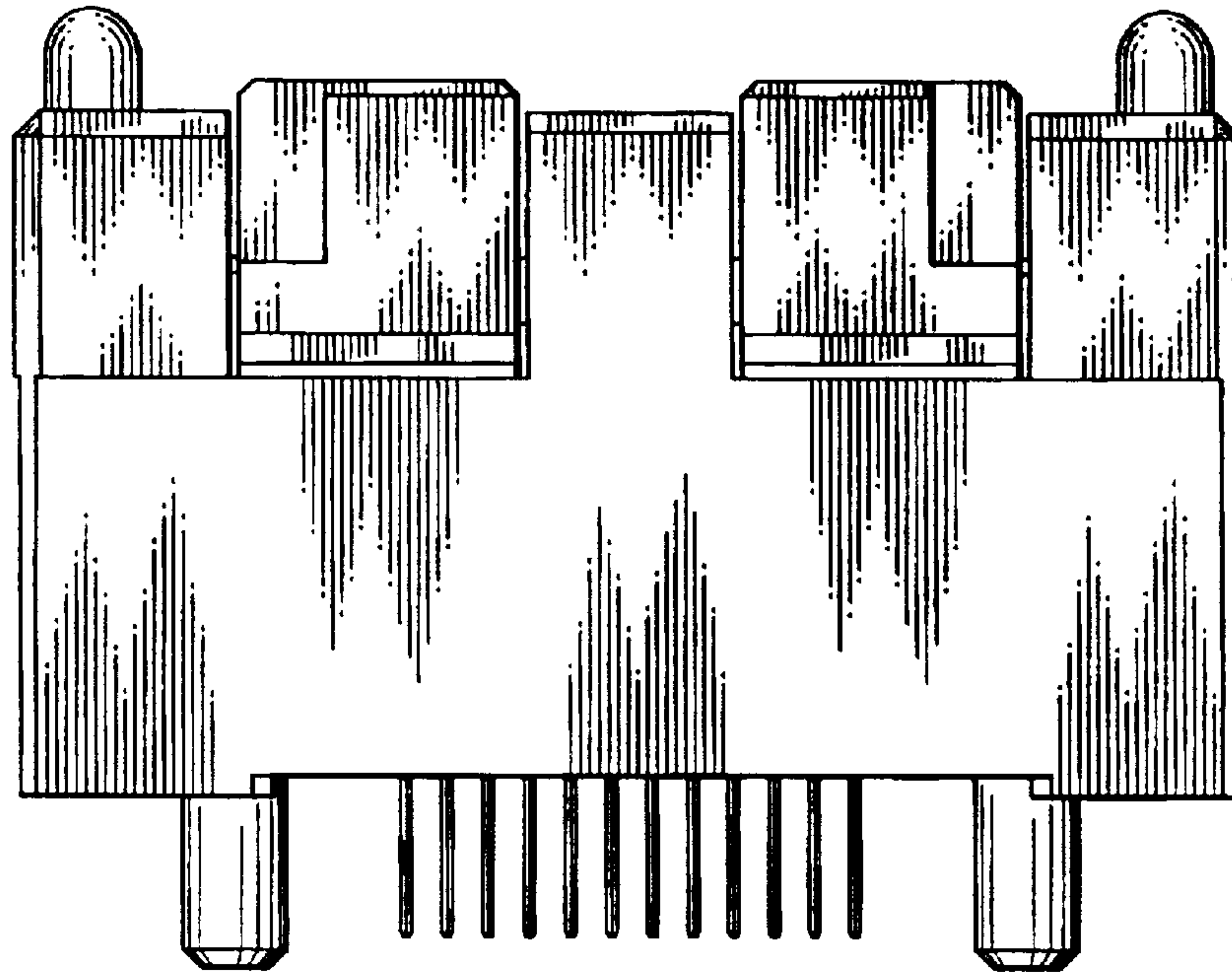

FIG.1

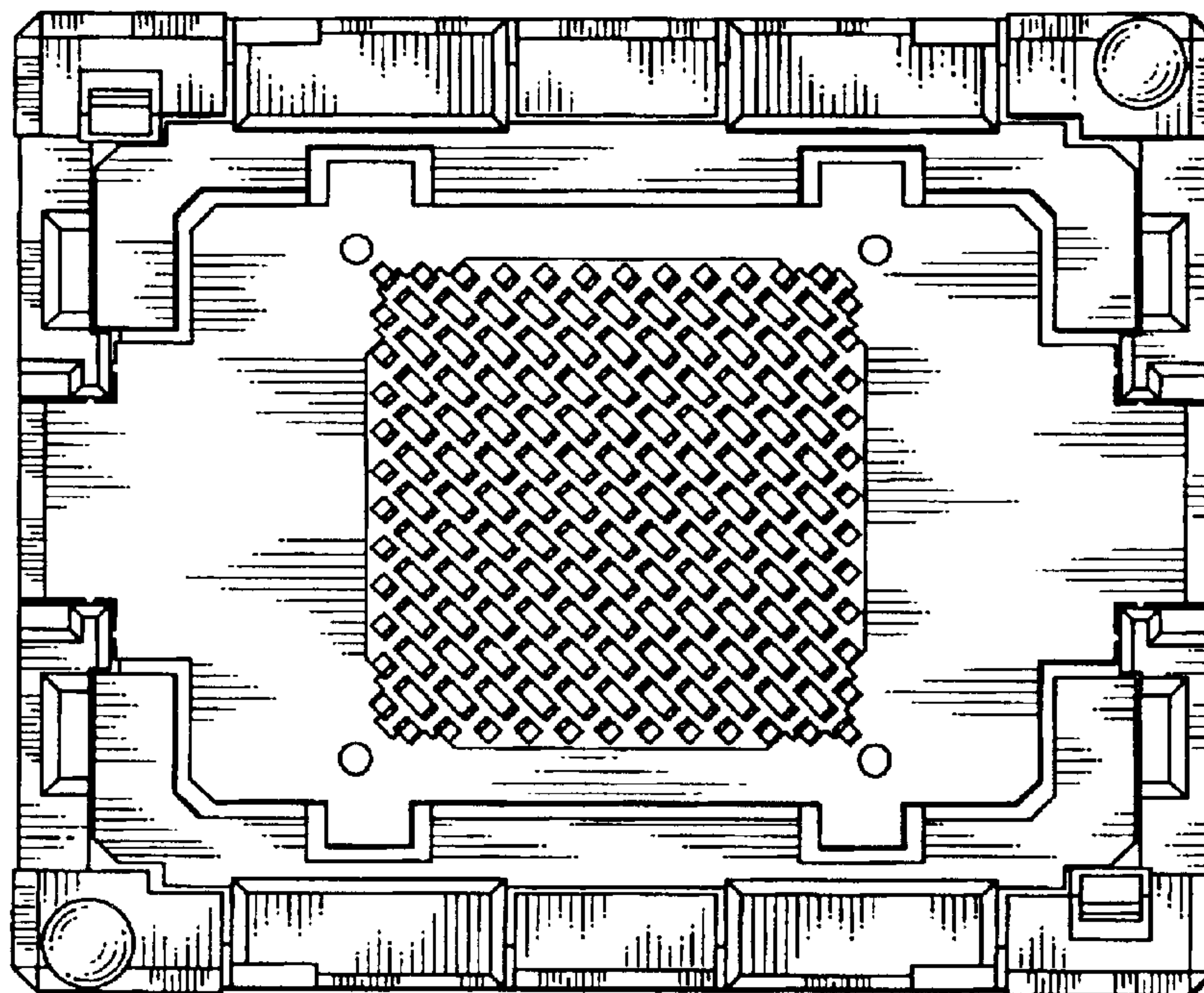



**FIG.2**



**FIG.3**



**FIG.4**

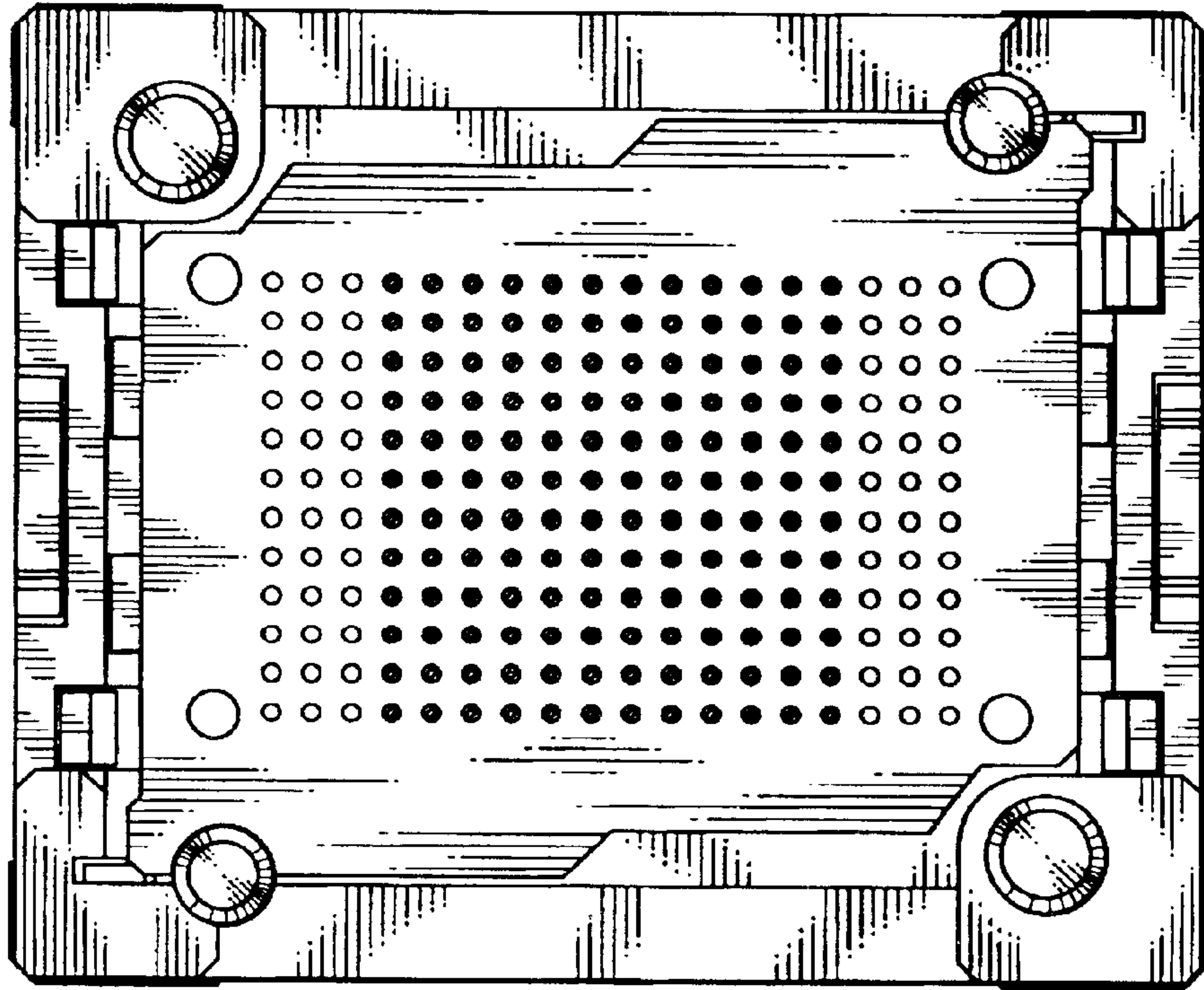

**FIG.5**

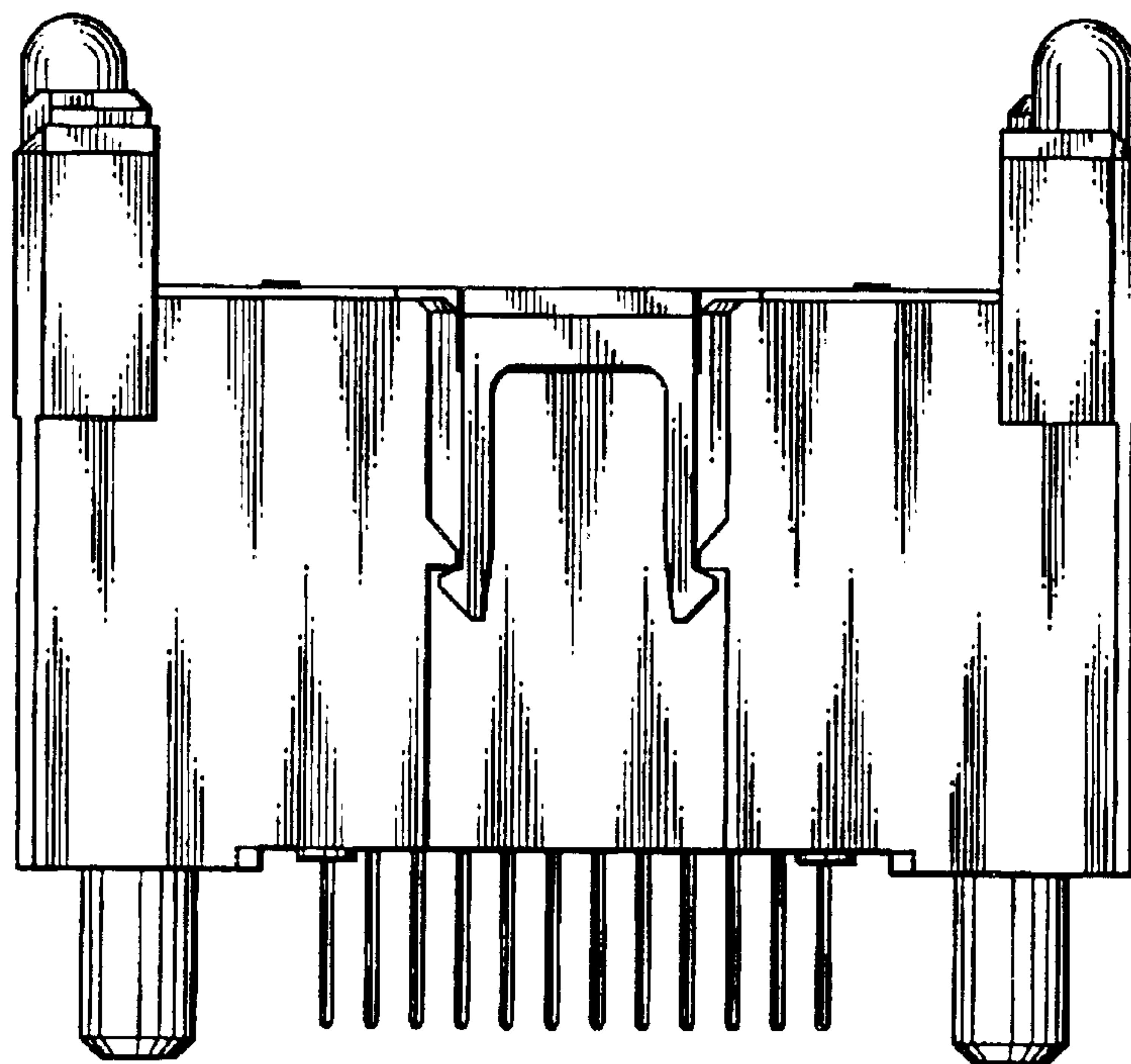

FIG.6

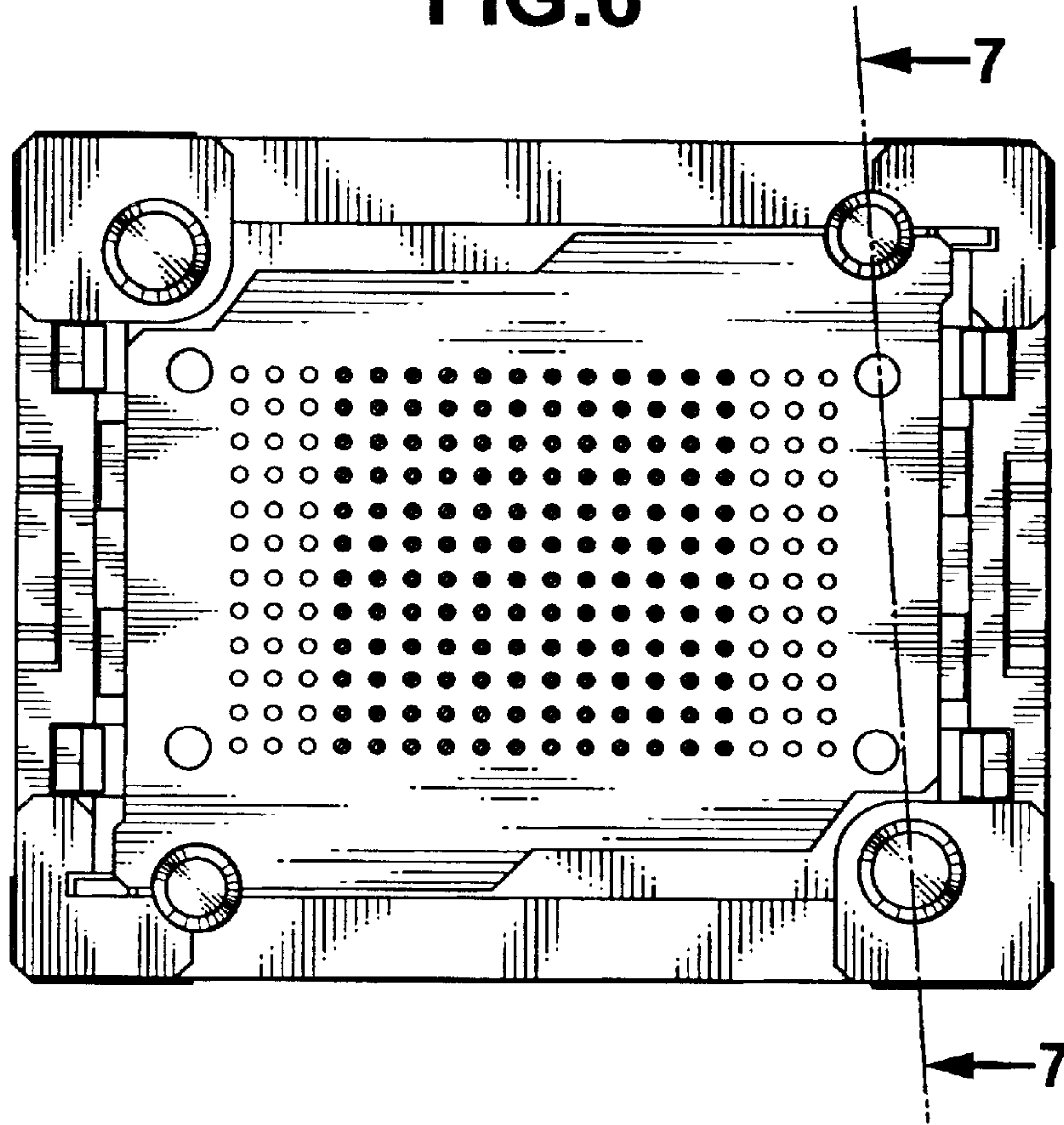

FIG.7

