



US00D522891S

(12) **United States Design Patent**
Huang

(10) **Patent No.:** **US D522,891 S**

(45) **Date of Patent:** **** Jun. 13, 2006**

(54) **TH TYPE TAPE RULE**

D476,585 S * 7/2003 Hsu D10/72
D491,082 S * 6/2004 Hsu D10/72

(75) Inventor: **Jason Huang**, Taipei (TW)

* cited by examiner

(73) Assignee: **Index Measuring Tape Co.**, Taipei (TW)

Primary Examiner—Antoine D. Davis

Assistant Examiner—Patricia Palasik

(**) Term: **14 Years**

(74) *Attorney, Agent, or Firm*—Troxell Law Office, PLLC

(21) Appl. No.: **29/239,757**

(57) **CLAIM**

(22) Filed: **Oct. 5, 2005**

The ornamental design for a TH type tape rule, as shown and described.

(51) **LOC (8) Cl.** **10-04**

(52) **U.S. Cl.** **D10/72**

(58) **Field of Classification Search** D10/72;
33/775-771; 242/292, 381.1, 381.2, 381.3,
242/381.4, 381.5, 381.6

See application file for complete search history.

DESCRIPTION

FIG. 1 is a perspective view of a tape rule showing my new design;

FIG. 2 is a front view thereof;

FIG. 3 is a rear view thereof;

FIG. 4 is a left side view thereof;

FIG. 5 is a right side view thereof;

FIG. 6 is a top plan view thereof; and,

FIG. 7 is a bottom plan view thereof.

(56) **References Cited**

U.S. PATENT DOCUMENTS

D415,047 S * 10/1999 Hsu D10/72

D424,955 S * 5/2000 Hizawa et al. D10/72

1 Claim, 4 Drawing Sheets

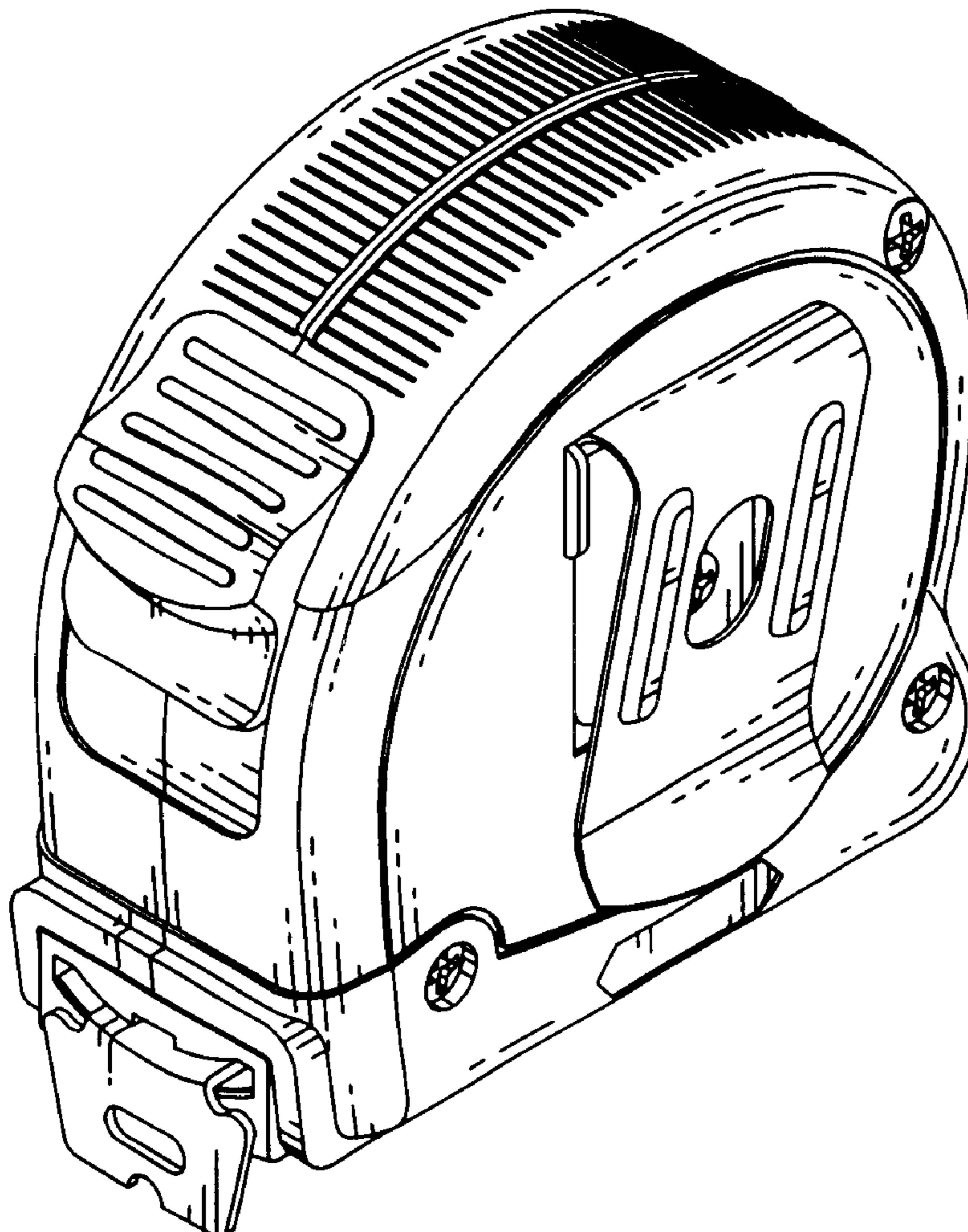

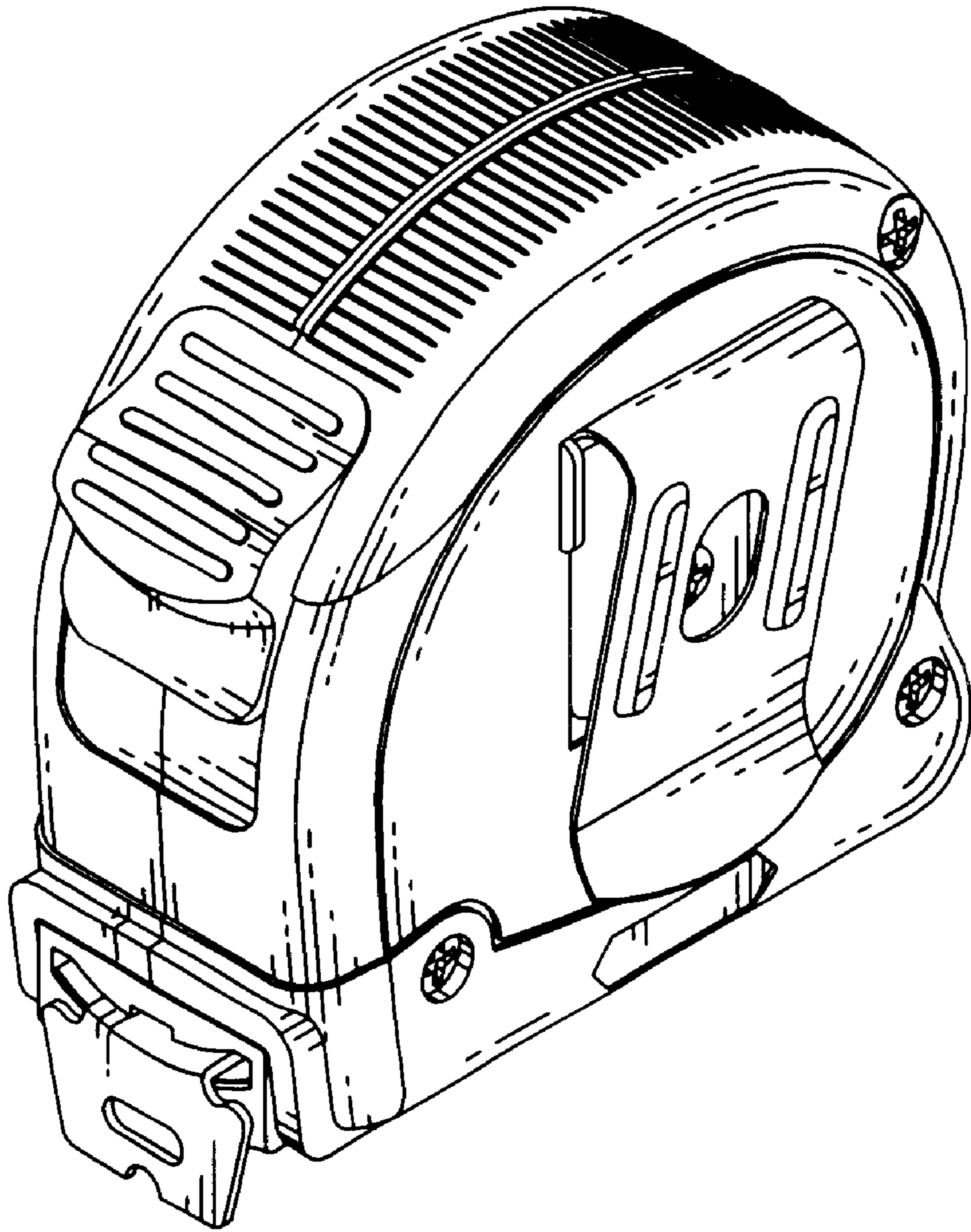

FIG. 1

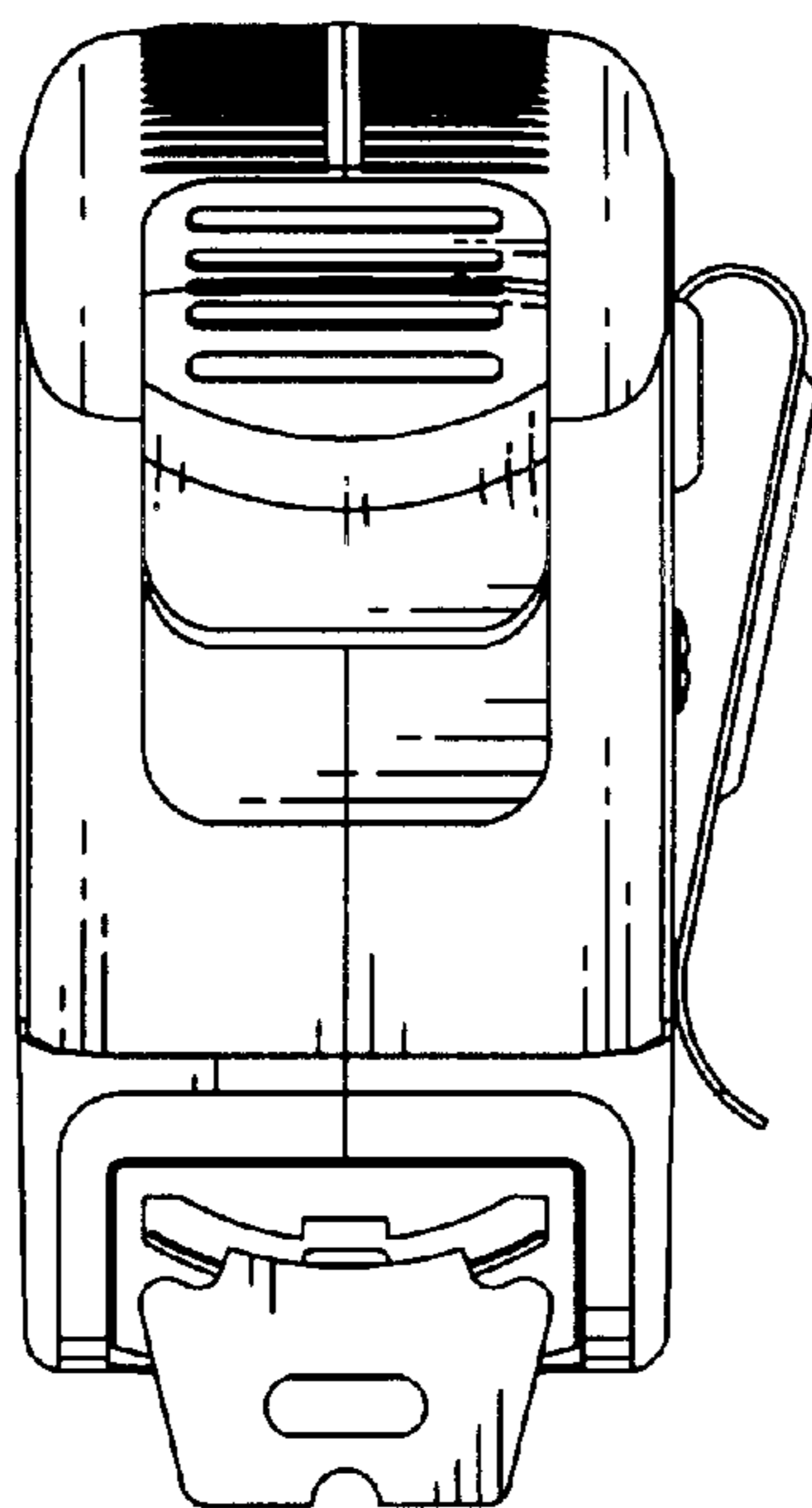

FIG. 2

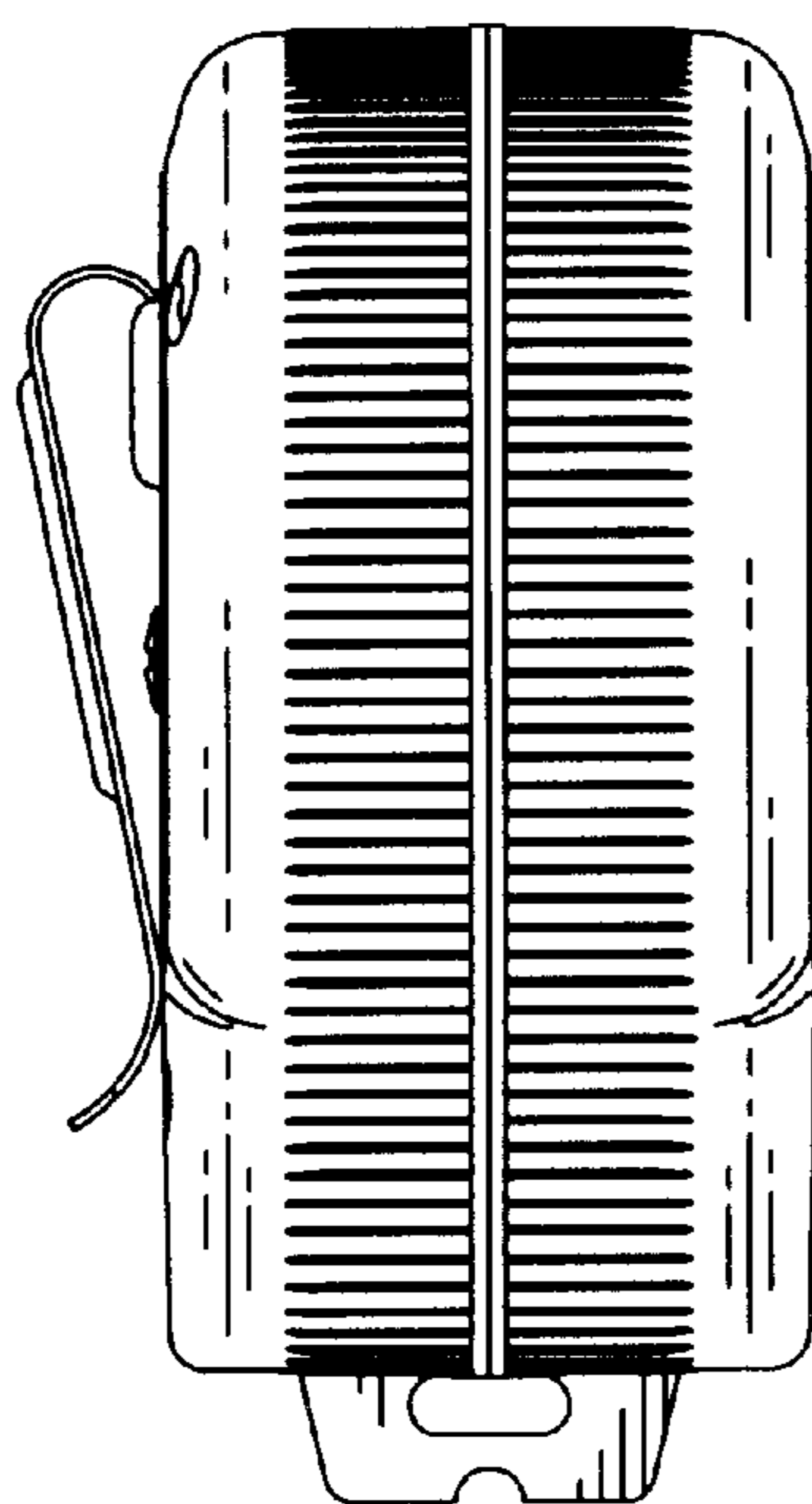

FIG. 3

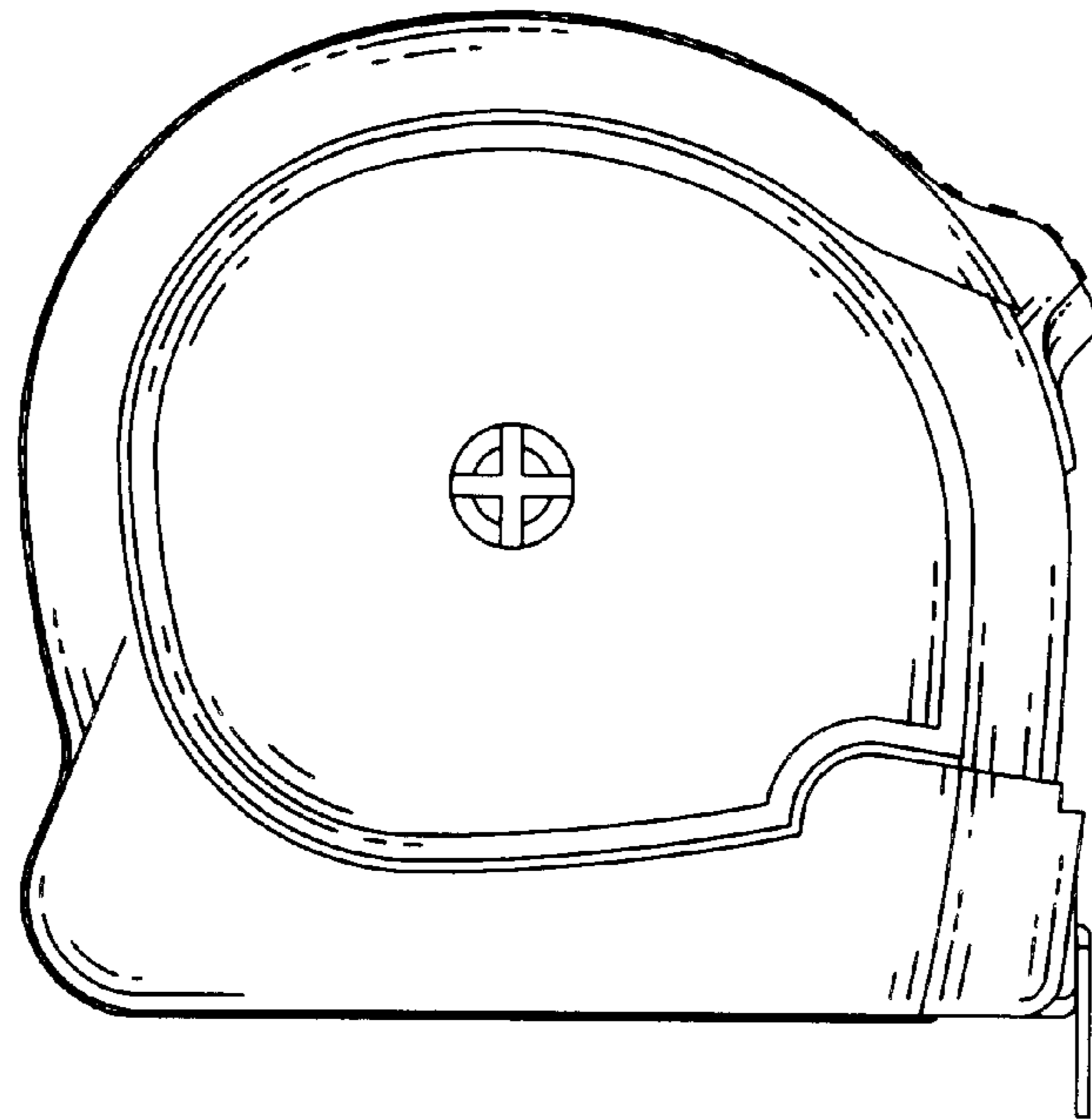

FIG. 4

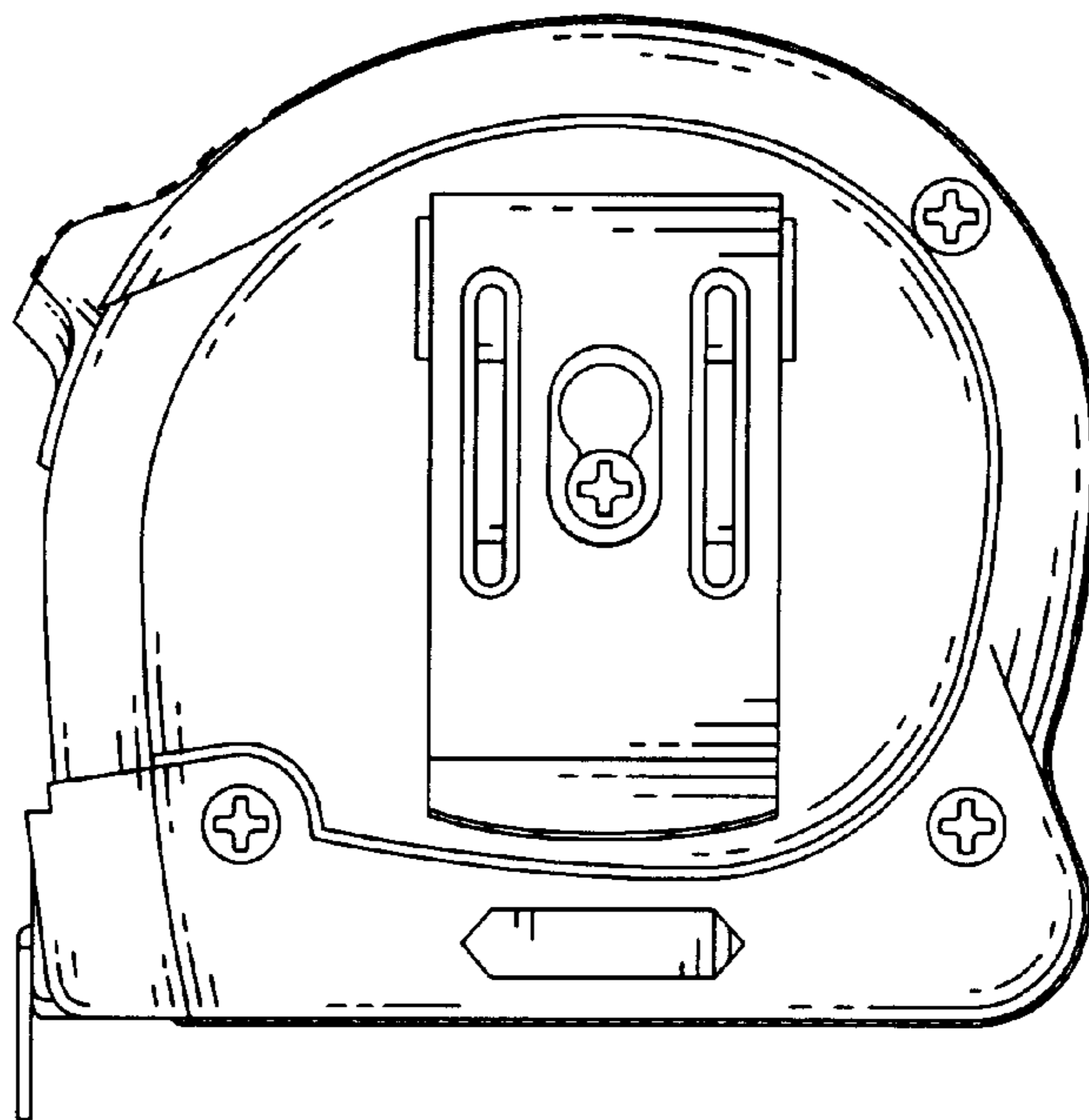

FIG. 5

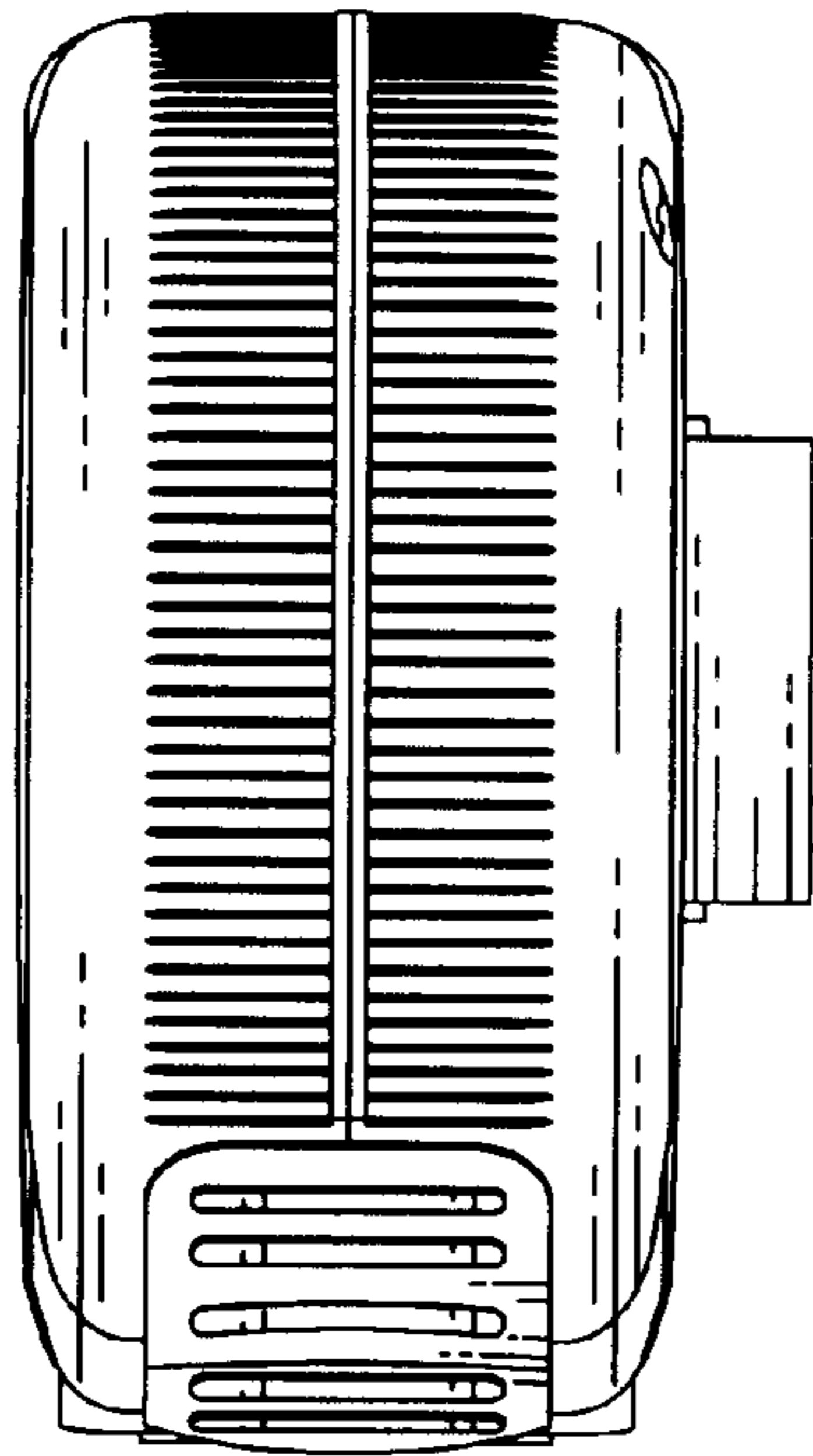

FIG. 6

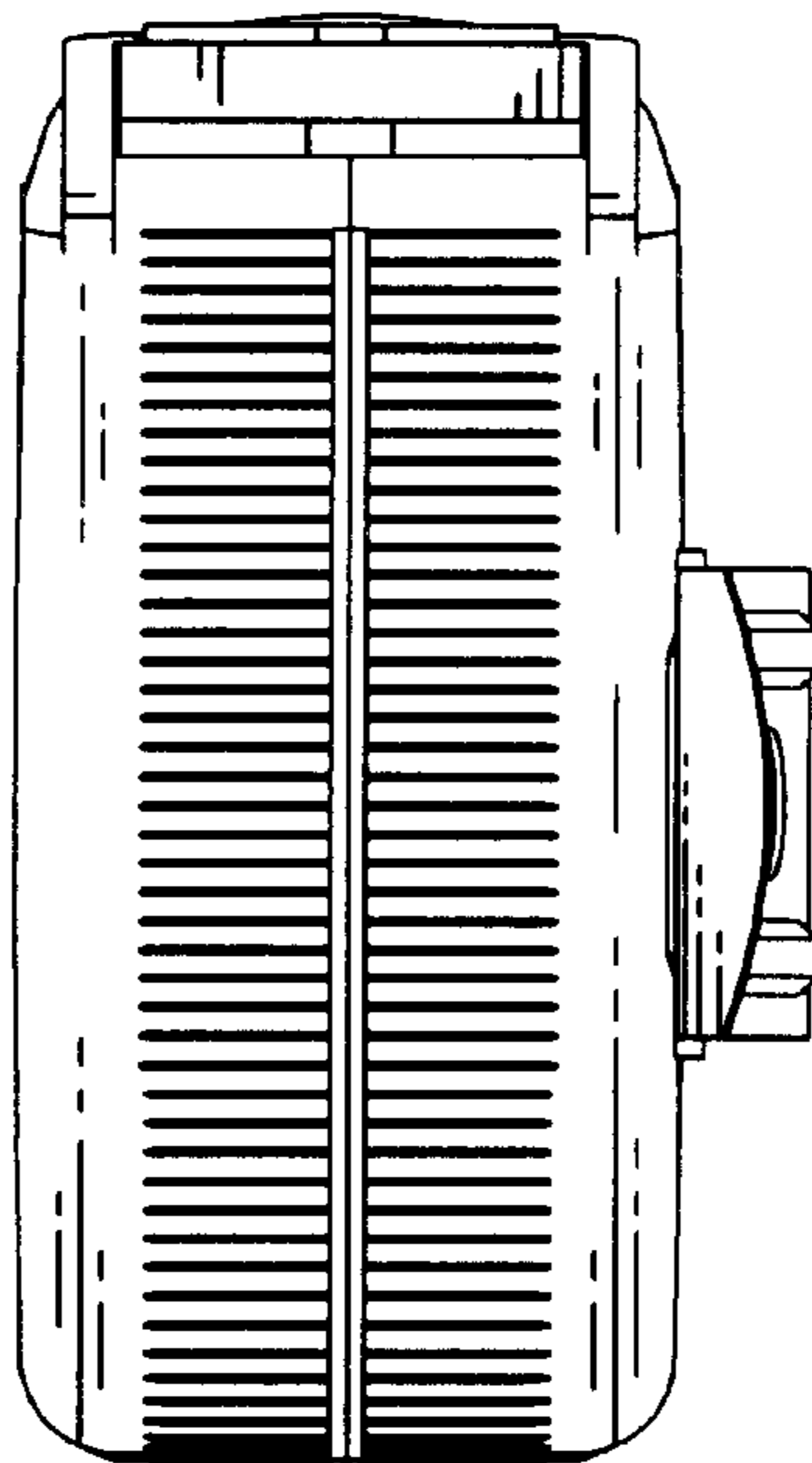

FIG. 7