



US00D522748S

(12) **United States Design Patent**
Kim

(10) **Patent No.:** **US D522,748 S**
(45) **Date of Patent:** **** Jun. 13, 2006**

(54) **FABRIC COVERED NECKTIE CONTAINER**

(75) Inventor: **Cin Kim**, Alpine, NJ (US)

(73) Assignee: **Paacock Apparel Group, Inc.**, New York, NY (US)

(**) Term: **14 Years**

(21) Appl. No.: **29/218,910**

(22) Filed: **Dec. 9, 2004**

(51) **LOC (8) Cl.** **03-01**

(52) **U.S. Cl.** **D3/294**

(58) **Field of Classification Search** D3/290,
D3/294, 299, 901, 903; D28/73, 75, 91; 206/278,
206/292, 294, 296-297, 478, 482, 565; D9/414,
D9/432, 700

See application file for complete search history.

(56) **References Cited**

U.S. PATENT DOCUMENTS

1,479,328	A	*	1/1924	Sinel	229/103.2
1,662,039	A	*	3/1928	Heynen	206/747
D95,170	S	*	4/1935	Baumgard	D3/206
2,057,838	A	*	10/1936	Levy	206/297
D297,214	S	*	8/1988	Forbes, Jr.	D9/416

D351,104	S	*	10/1994	Kapp	D9/423
D395,755	S	*	7/1998	Hulin	D3/295
D424,296	S	*	5/2000	David	D3/273
D511,681	S	*	11/2005	Cogley et al.	D9/416

* cited by examiner

Primary Examiner—Raphael Barkai

Assistant Examiner—RoseLynne Ulm

(74) *Attorney, Agent, or Firm*—Darby & Darby

(57) **CLAIM**

The ornamental design for a fabric covered necktie container, as shown and described.

DESCRIPTION

FIG. 1 is a perspective view of a fabric covered necktie container shown in a closed position; FIG. 2 is a front view thereof; FIG. 3 is a side view thereof; FIG. 4 is a top view thereof; FIG. 5 is a back view thereof; FIG. 6 is a bottom view thereof; and, FIG. 7 is a perspective view of the fabric covered necktie container of FIG. 1 shown in an open position. The texture shown in all views of the drawing disclosure represents fabric, but no particular color or pattern.

1 Claim, 4 Drawing Sheets

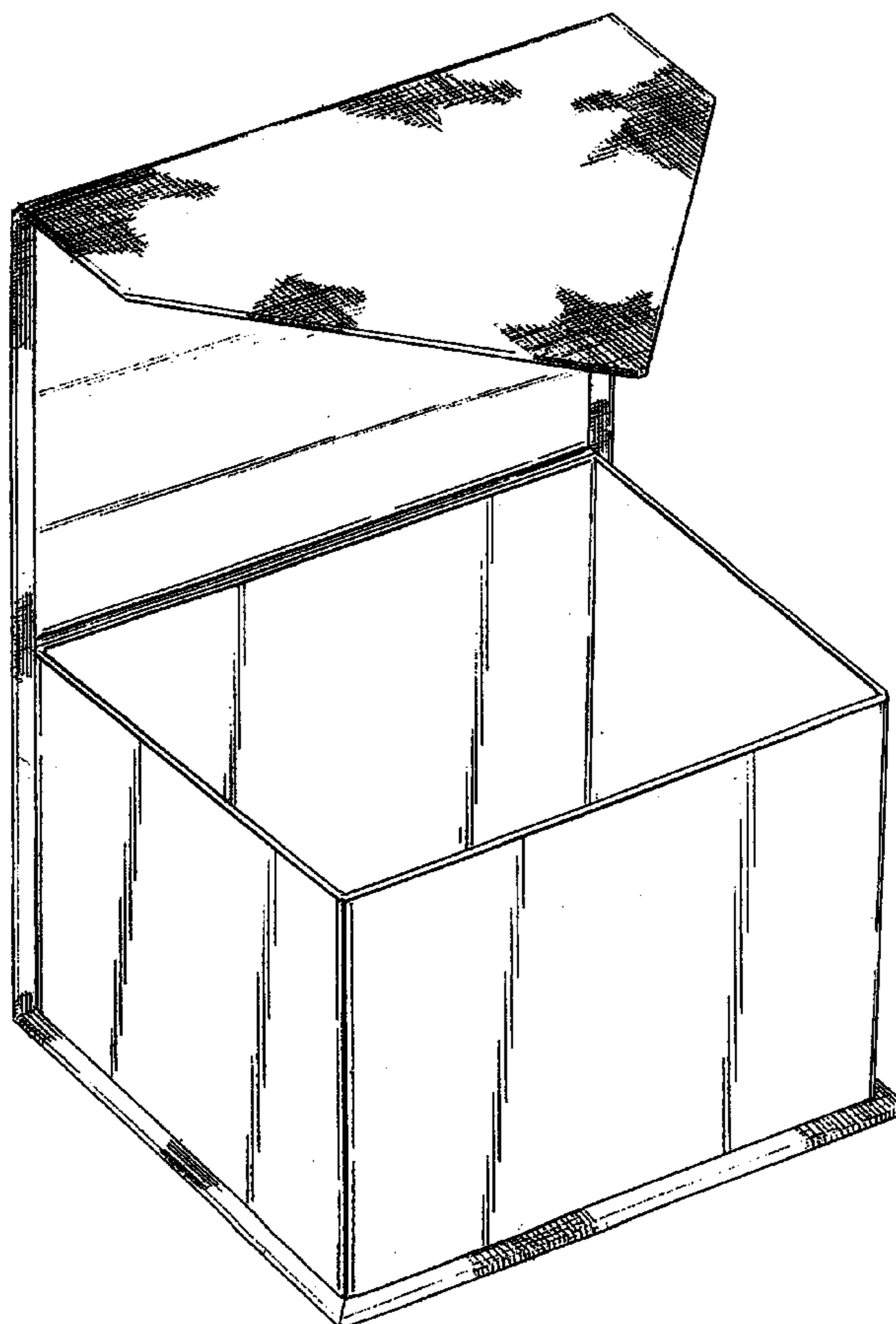

FIG. 1

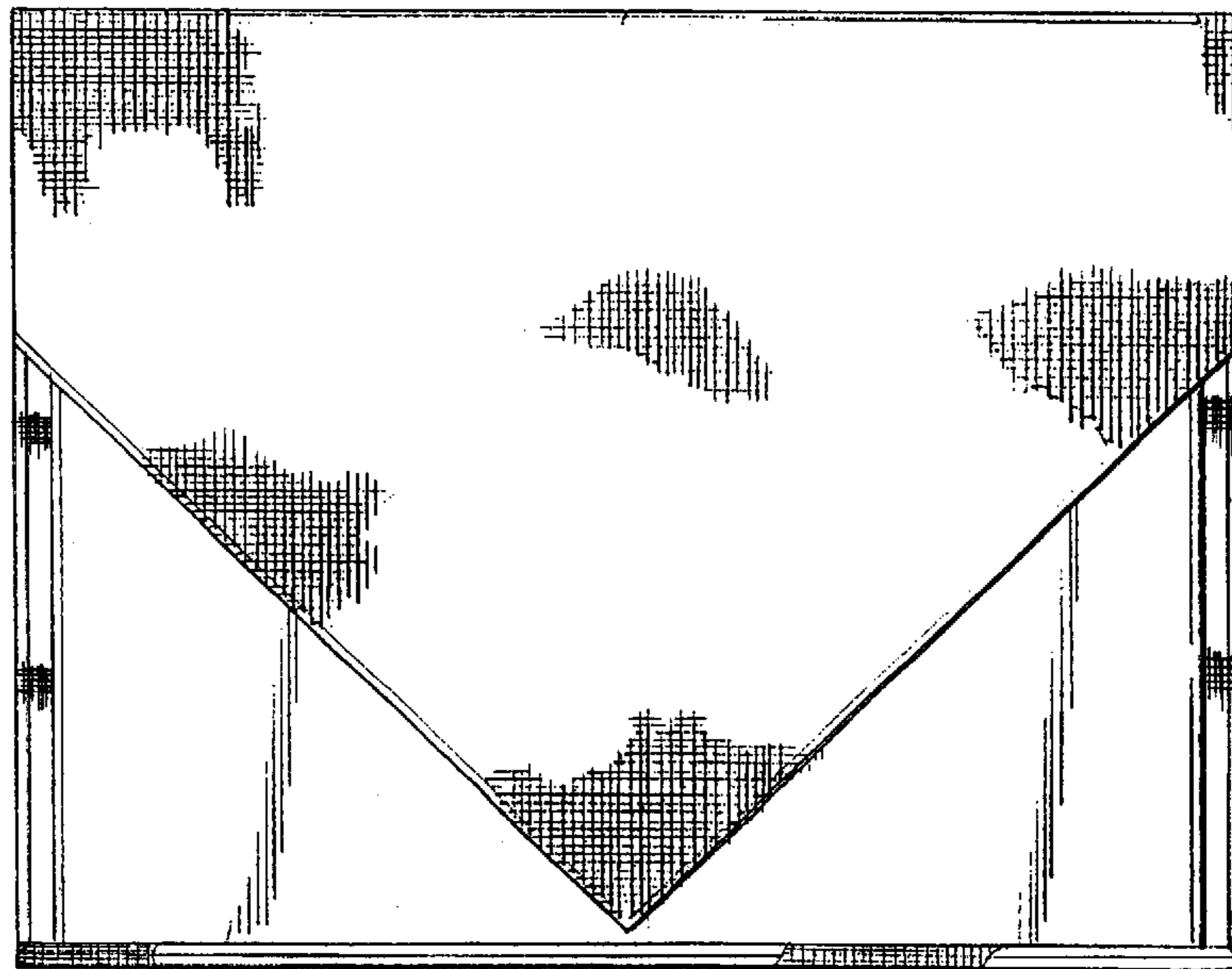
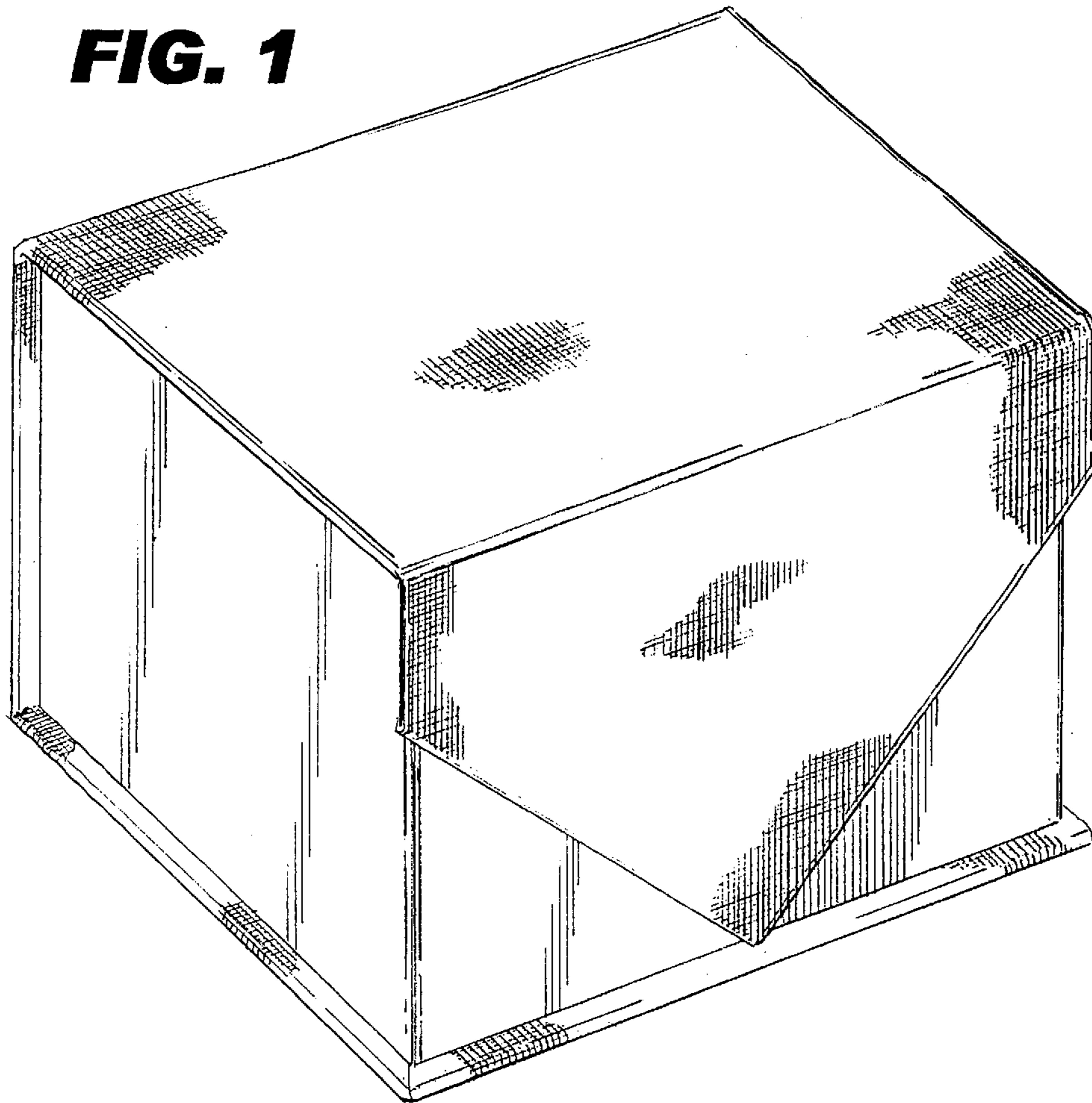

FIG. 2

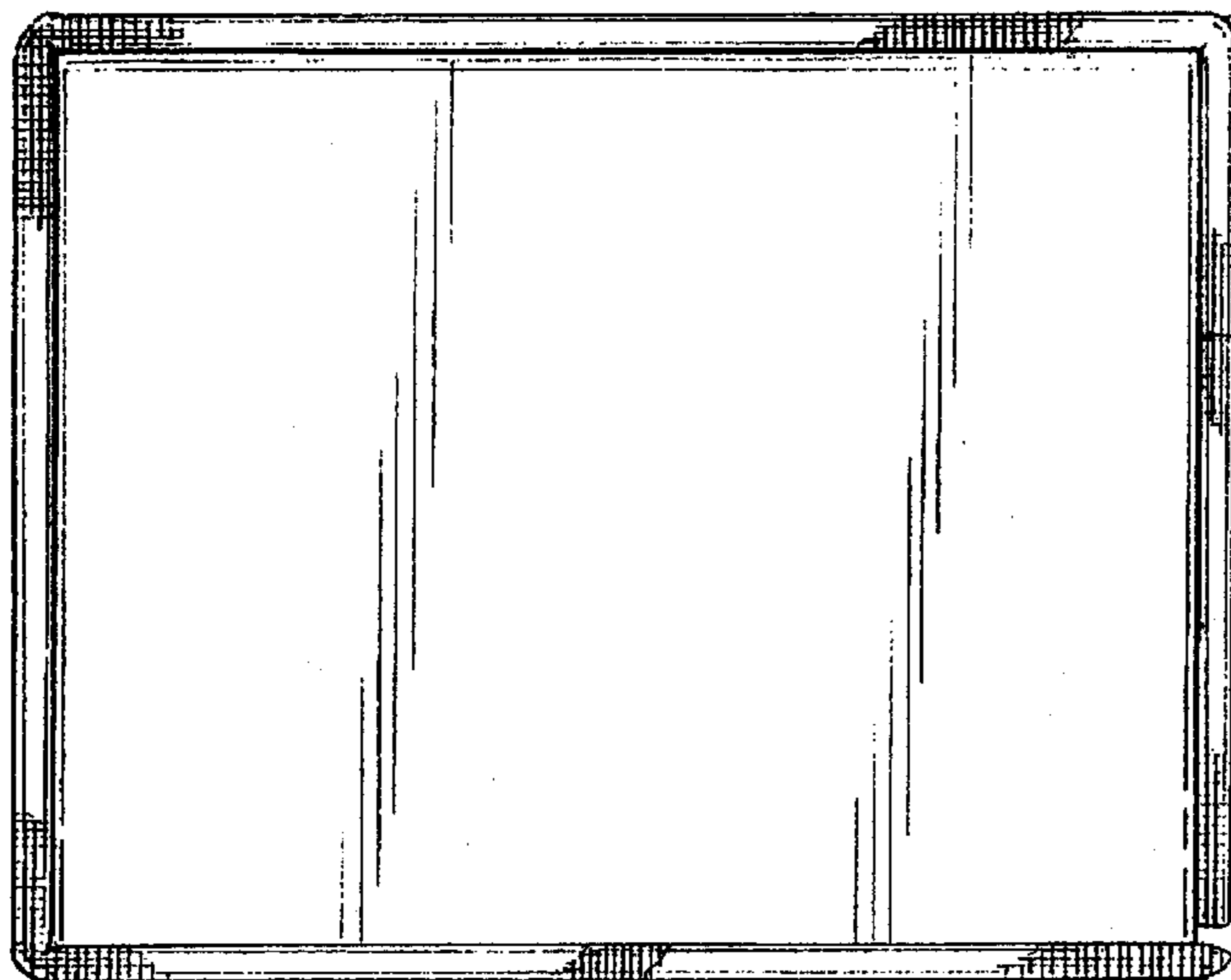

FIG. 3

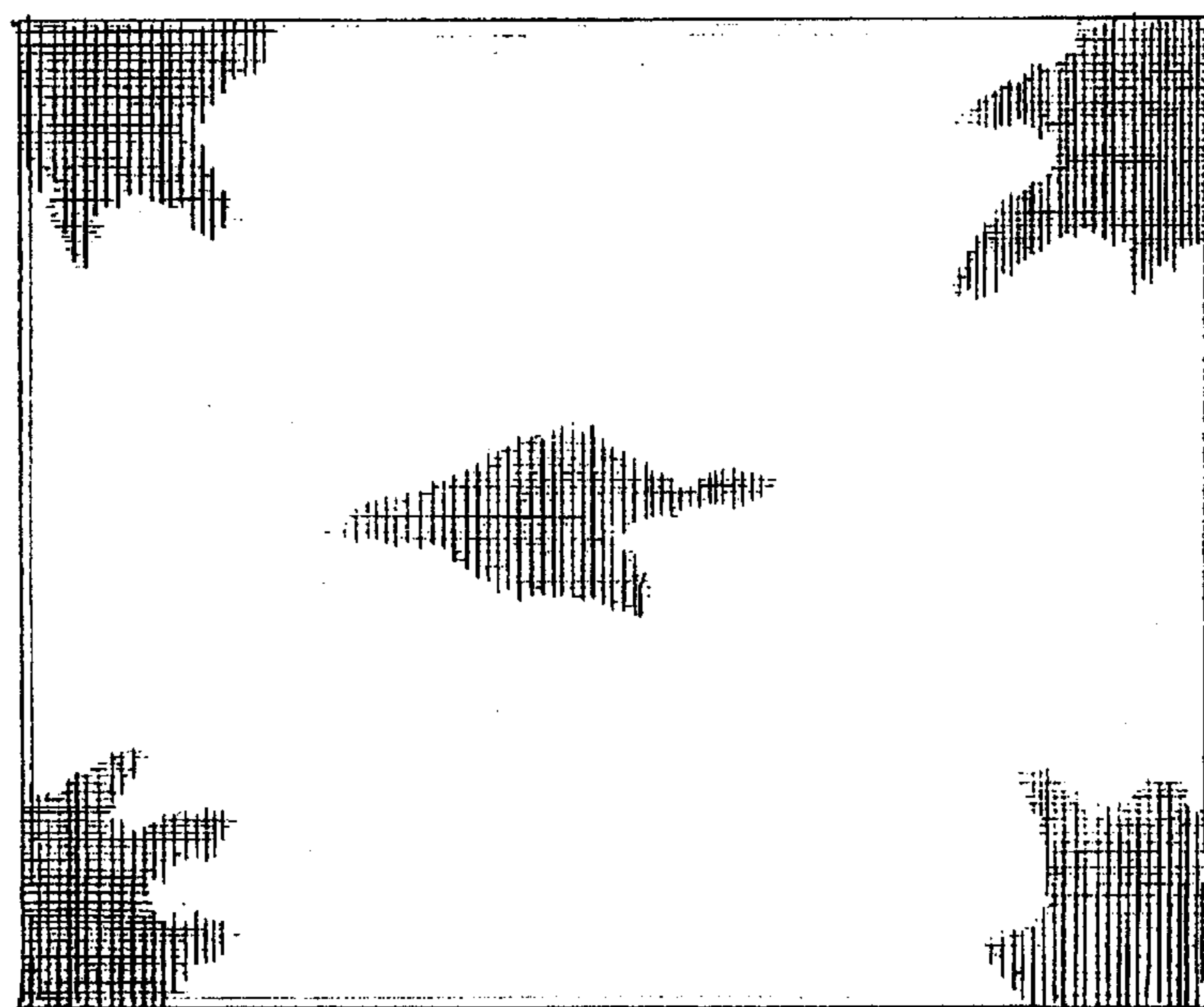

FIG. 4

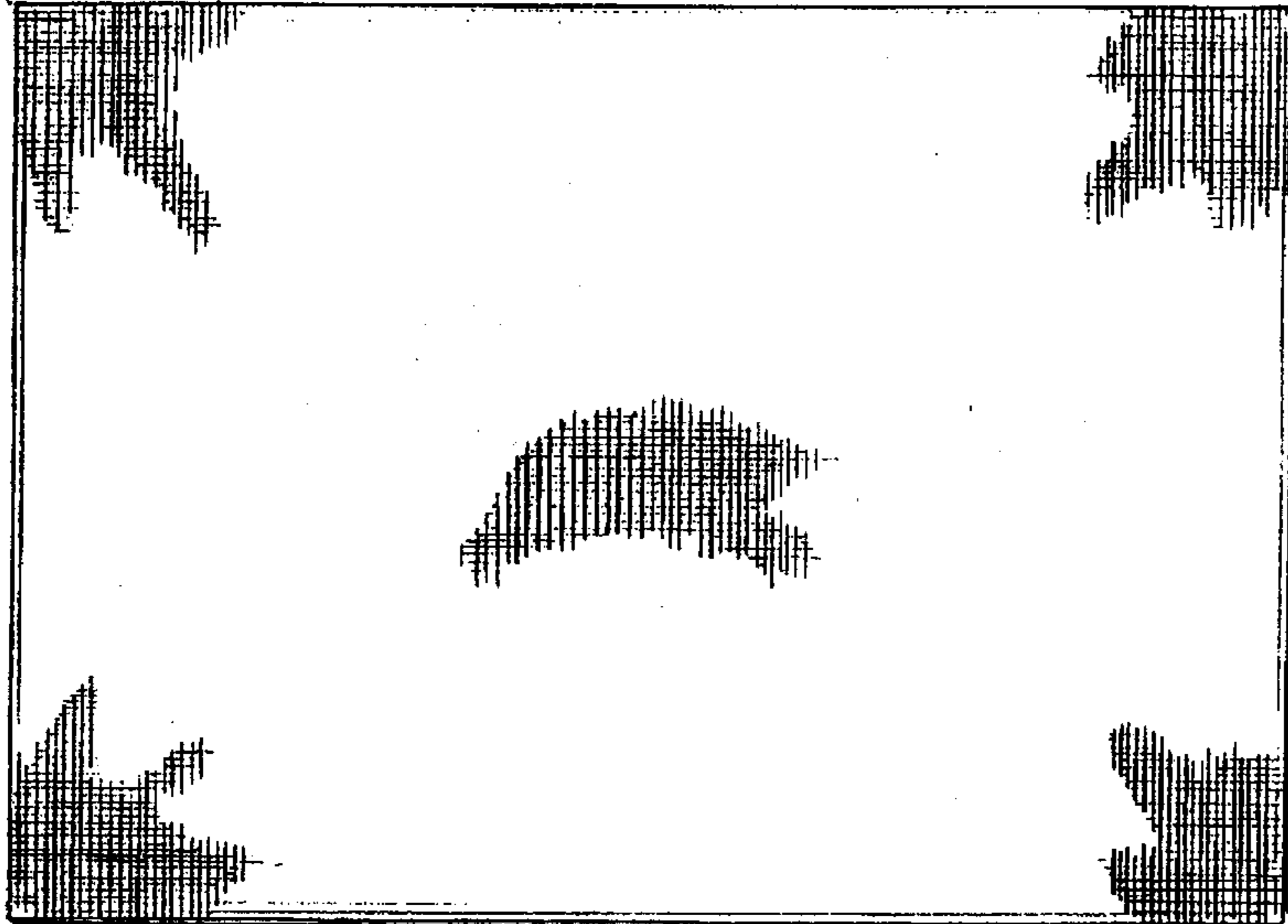

FIG. 5

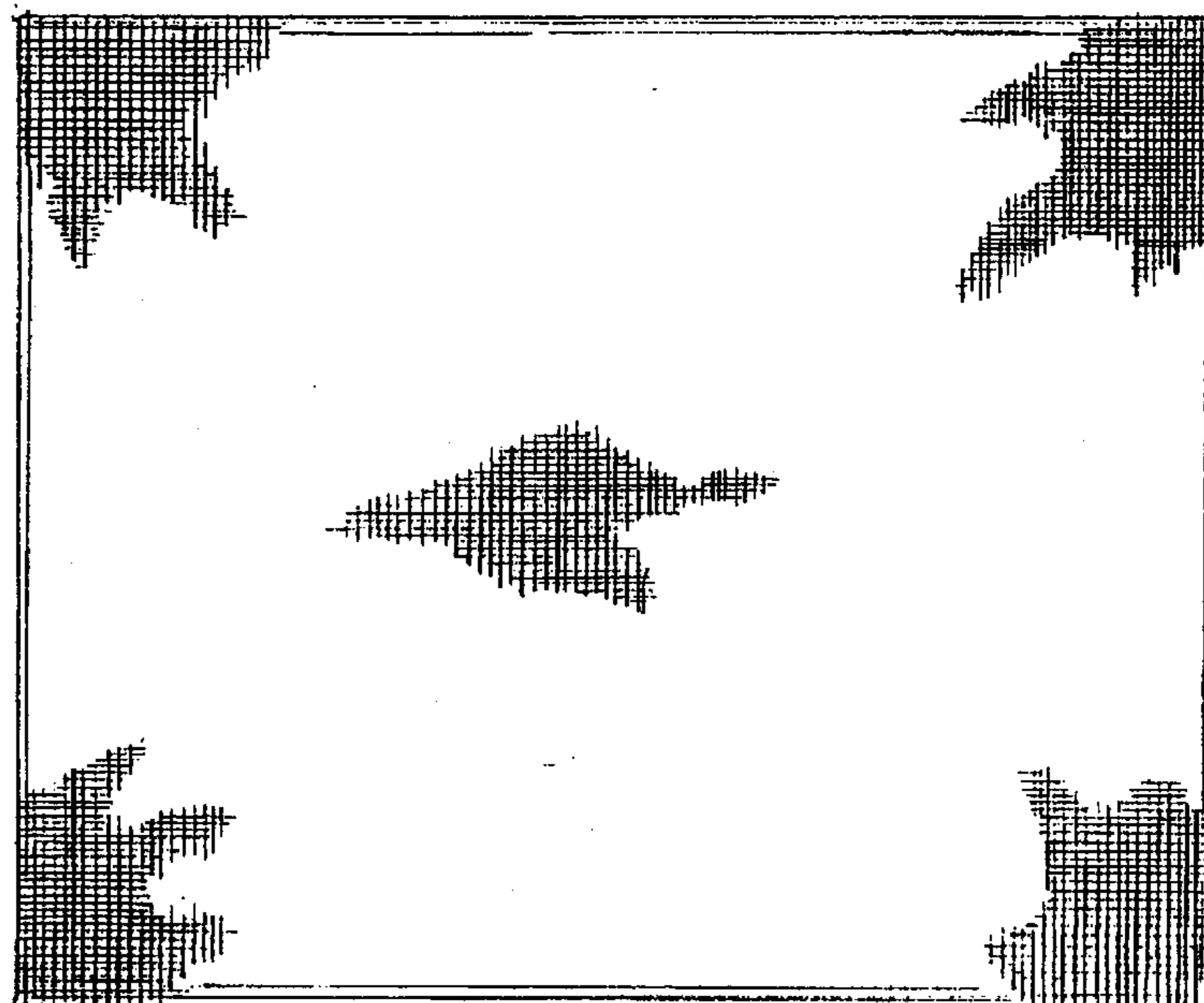
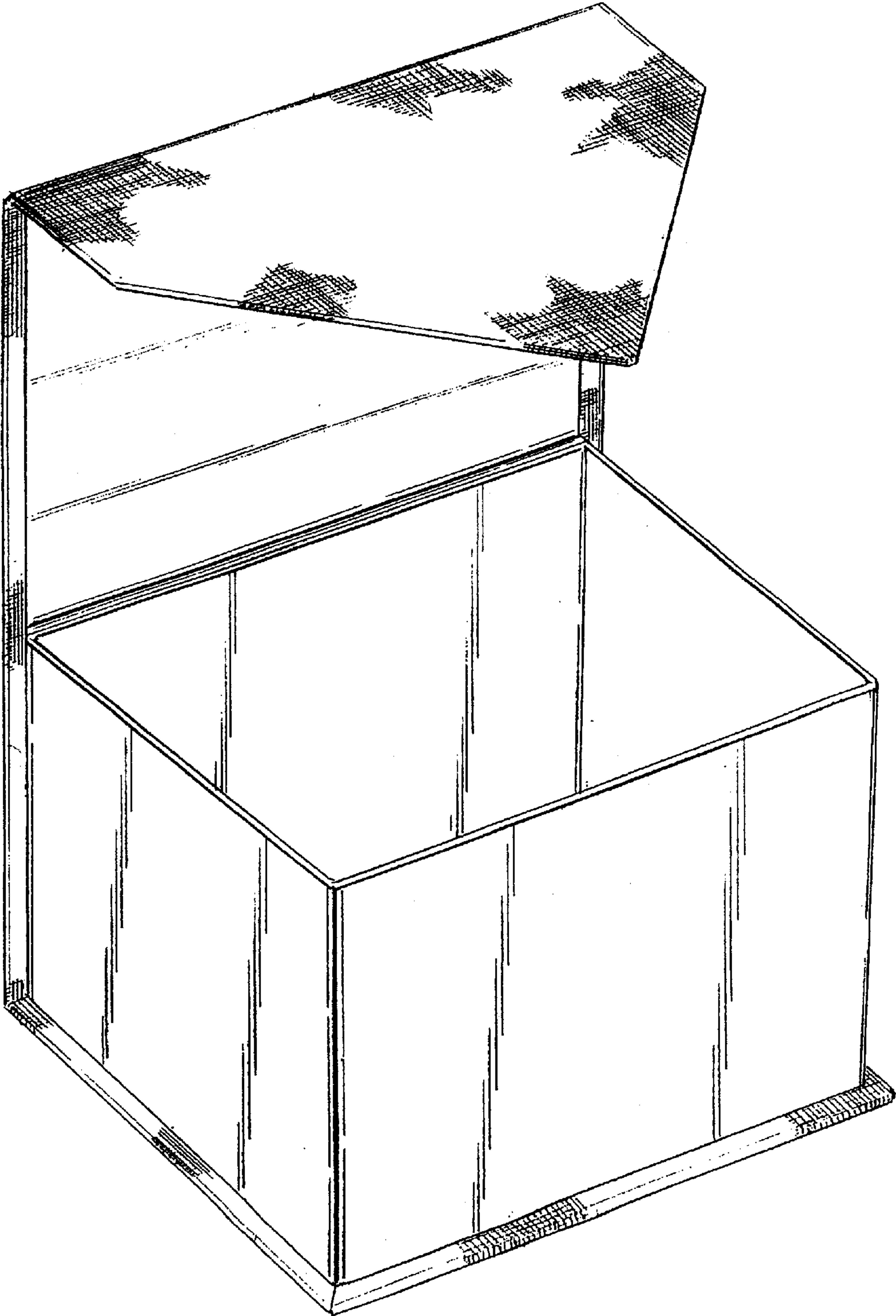

FIG. 6

FIG. 7



UNITED STATES PATENT AND TRADEMARK OFFICE
CERTIFICATE OF CORRECTION

PATENT NO. : Des. 522,748 S
APPLICATION NO. : 29/218910
DATED : June 13, 2006
INVENTOR(S) : Cin Kim

Page 1 of 1

It is certified that error appears in the above-identified patent and that said Letters Patent is hereby corrected as shown below:

On title page (item 73)
In the Assignee:

In the Assignee please delete "Paacock Apparel Group, Inc., New York, NY" and substitute with -- Peacock Apparel Group, Inc., New York, NY --.

Signed and Sealed this

Fifth Day of September, 2006

A handwritten signature in black ink on a dotted background. The signature reads "Jon W. Dudas" in a cursive style.

JON W. DUDAS

Director of the United States Patent and Trademark Office

UNITED STATES PATENT AND TRADEMARK OFFICE
CERTIFICATE OF CORRECTION

PATENT NO. : Des. 522,748 S
APPLICATION NO. : 29/218910
DATED : June 13, 2006
INVENTOR(S) : Cin Kim

Page 1 of 1

It is certified that error appears in the above-identified patent and that said Letters Patent is hereby corrected as shown below:

Title Page
In the Assignee:

Item [73]
In the Assignee please delete "Paacock Apparel Group, Inc., New York, NY" and
substitute with -- Peacock Apparel Group, Inc., New York, NY --.

Signed and Sealed this

Twelfth Day of June, 2007

A handwritten signature in black ink on a light gray dotted background. The signature reads "Jon W. Dudas" in a cursive, stylized font.

JON W. DUDAS

Director of the United States Patent and Trademark Office