



US00D522707S

(12) **United States Design Patent** (10) **Patent No.:** **US D522,707 S**
Obbitts et al. (45) **Date of Patent:** **** Jun. 6, 2006**

(54) **MECHANIC'S CREEPER**
(75) Inventors: **Shane Obbitts**, Elyria, OH (US);
Tenille Schoonover, Sunbury, OH
(US); **Kristin C. Mays**, Delaware, OH
(US); **Kirt E. Whiteside**, Marion, OH
(US)

(73) Assignee: **Whiteside Mfg. Co.**, Delaware, OH
(US)

(**) Term: **14 Years**

(21) Appl. No.: **29/221,275**

(22) Filed: **Jan. 12, 2005**

(51) **LOC (8) Cl.** **12-02**

(52) **U.S. Cl.** **D34/23**

(58) **Field of Classification Search** D34/12-27;
280/30, 32.5, 32.6, 43.24, 79.2, 79.7, 79.11,
280/639, 640, 651; 248/129; 188/5

See application file for complete search history.

(56) **References Cited**

U.S. PATENT DOCUMENTS

D230,971 S	3/1974	Shanklin	D14/3 M
D325,799 S	4/1992	Chen	D34/23
5,174,592 A	12/1992	Pool	280/32.6
5,330,209 A	7/1994	Pool	280/32.6
D351,707 S	10/1994	Pill	D34/23
D384,466 S	* 9/1997	Taylor	D34/23
D396,920 S	8/1998	Whiteside et al.	D34/23
D398,433 S	9/1998	Whiteside et al.	D34/23
D401,029 S	* 11/1998	Taylor	D34/23
D401,714 S	11/1998	Whiteside et al.	D34/23
D401,715 S	11/1998	Whiteside et al.	D34/23
D403,822 S	1/1999	Whiteside et al.	D34/23
D406,433 S	* 3/1999	Taylor et al.	D34/23
D406,683 S	3/1999	Taylor et al.	D34/23
5,895,062 A	* 4/1999	Miles et al.	280/32.6
D409,344 S	5/1999	Whiteside et al.	D34/23

6,076,838 A	* 6/2000	Peterson et al.	280/32.6
D436,708 S	1/2001	Whiteside	D34/27
D458,432 S	6/2002	Whiteside et al.	D34/23
D460,237 S	* 7/2002	Hart	D34/23
6,705,622 B1	3/2004	Whiteside	280/32.6

OTHER PUBLICATIONS

Whiteside Catalog 95 advertisement, cover and 4 pages (1995).

P&B Mfg. Co. "Blue Max" advertisement, 1 page (1990).

Lisle "Creepers" advertisement, pp. 44 and 45 (undated).

E-Z Red "E-Z Rider" advertisement, 1 page (undated).

Wilmar Corporation "PT Performance Tool" product catalog, 2 pages (1996).

Petersen Automotive—Flambeau advertisement, 2 pages (undated).

United Auto Systems (Mac Tools) "Creepers" advertisement, 1 page (undated).

* cited by examiner

Primary Examiner—Alan P. Douglas

Assistant Examiner—Kevin K. Rudzinski

(74) *Attorney, Agent, or Firm*—Renner, Kenner, Greive, Bobak, Taylor & Weber

(57) **CLAIM**

The ornamental design for a mechanic's creeper, as shown and described.

DESCRIPTION

FIG. 1 is a top, right side, front perspective view of a mechanic's creeper showing our new design;

FIG. 2 is a top plan view thereof;

FIG. 3 is a bottom plan view thereof;

FIG. 4 is a left side elevational view thereof, the right side elevational view being a mirror image of FIG. 4;

FIG. 5 is a front elevational view thereof; and,

FIG. 6 is a rear elevational view thereof.

1 Claim, 4 Drawing Sheets

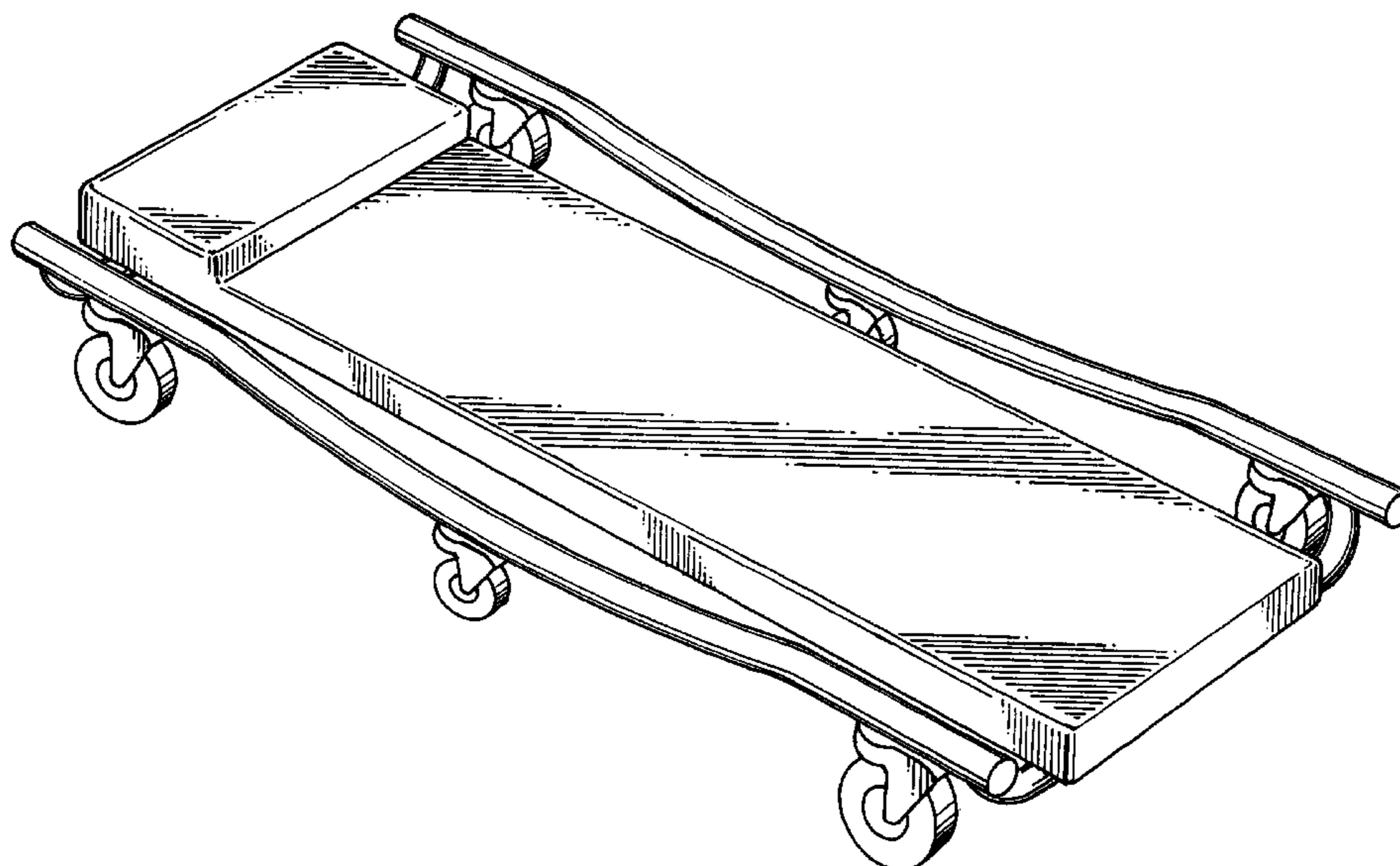

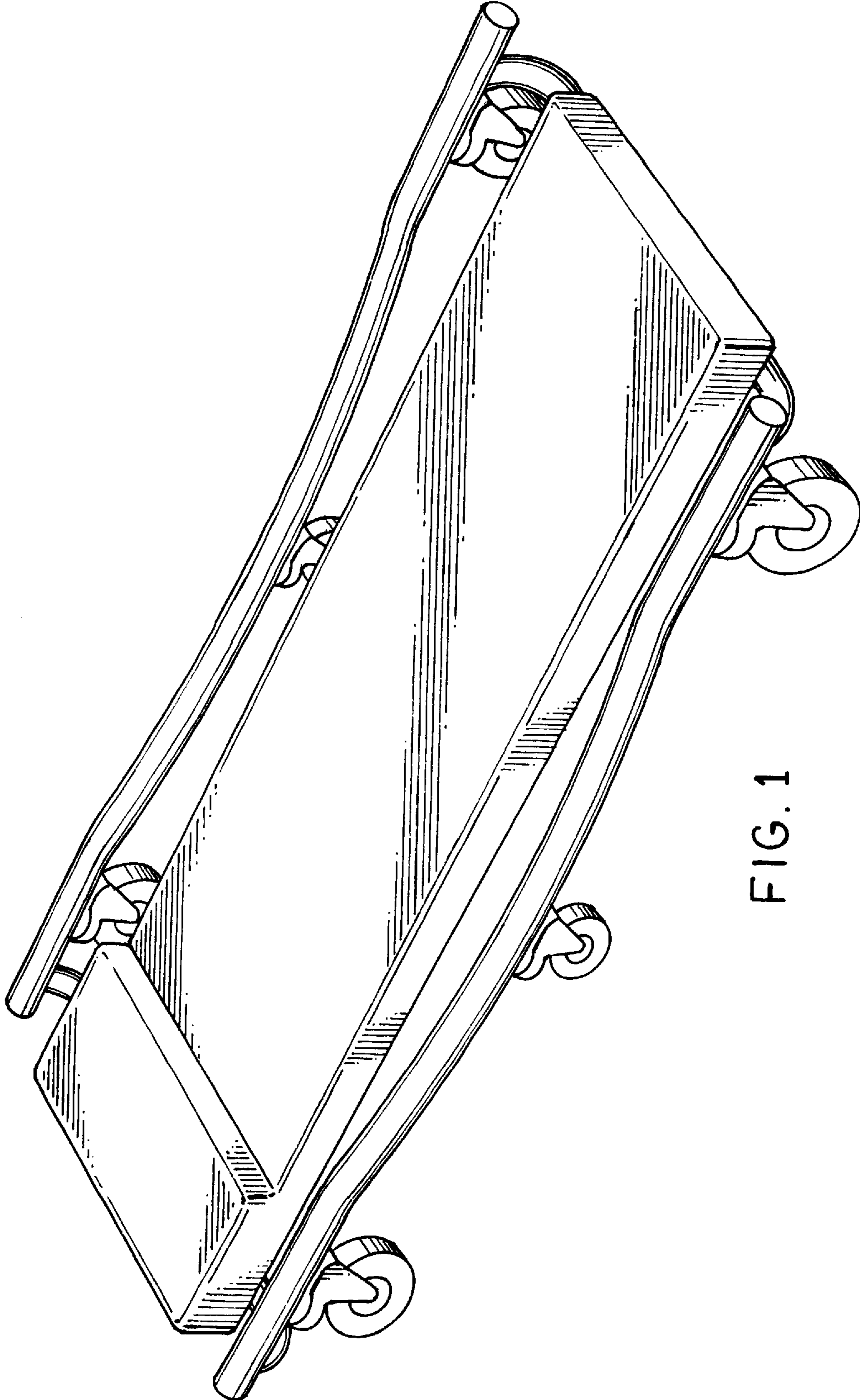

FIG. 1

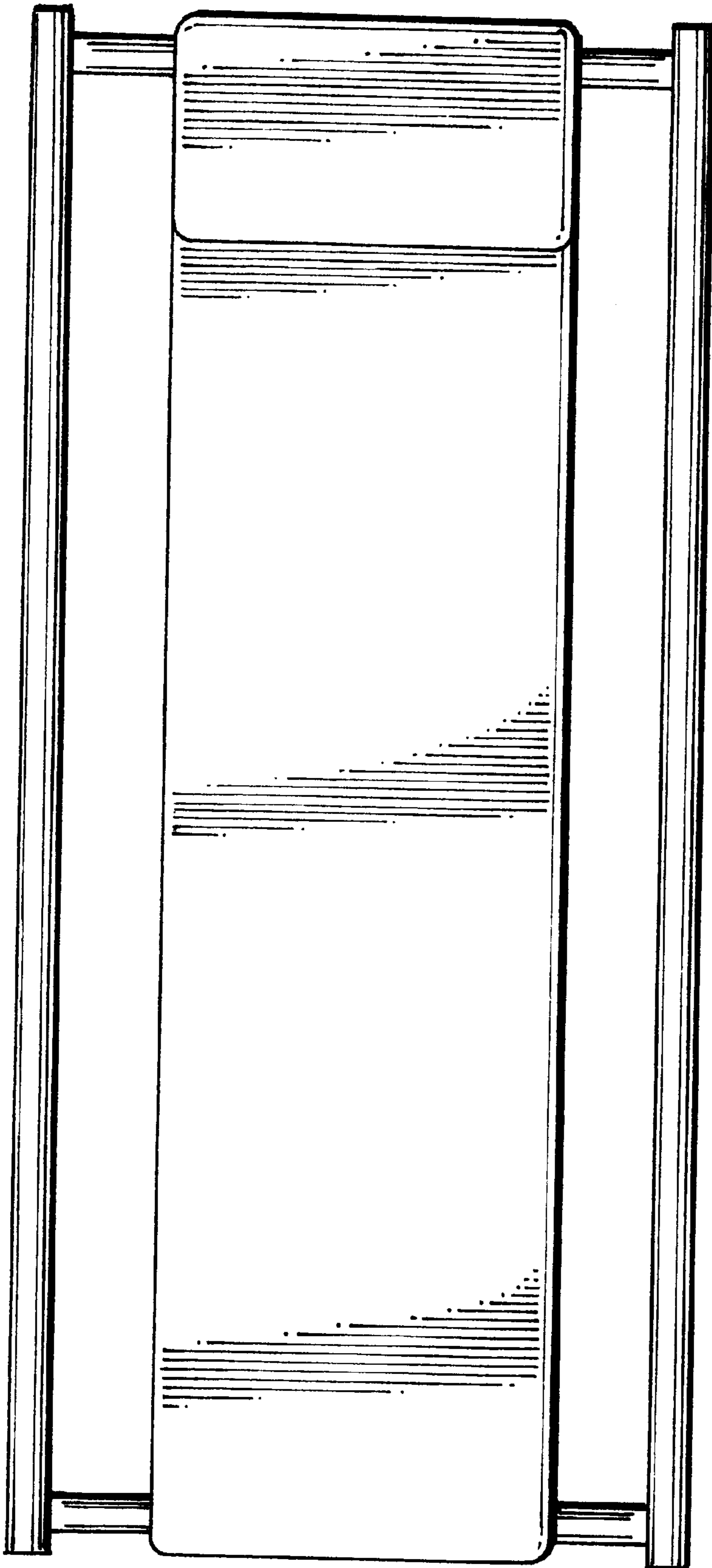

FIG. 2

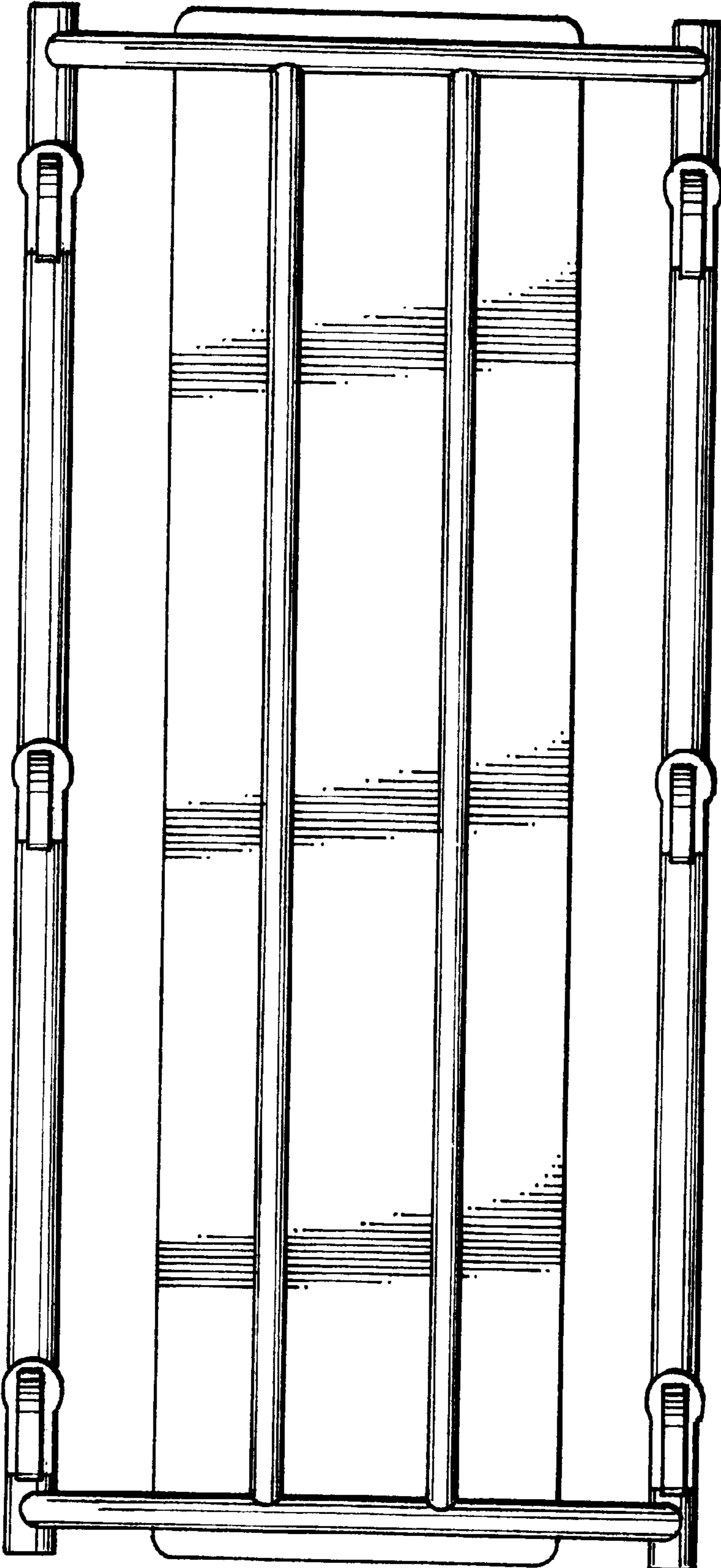

FIG. 3

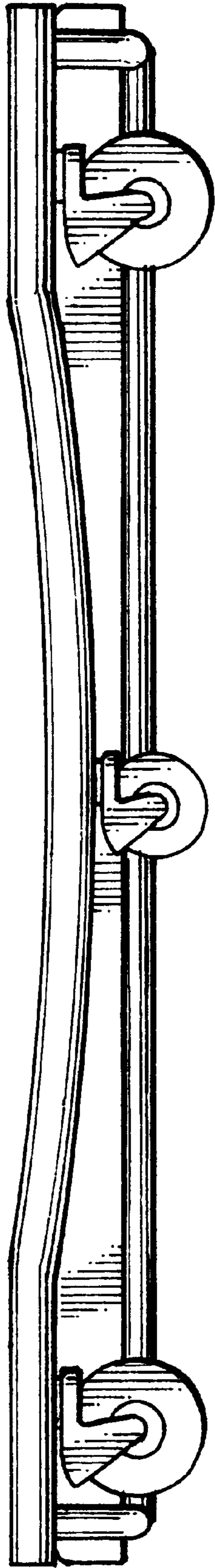

FIG. 4

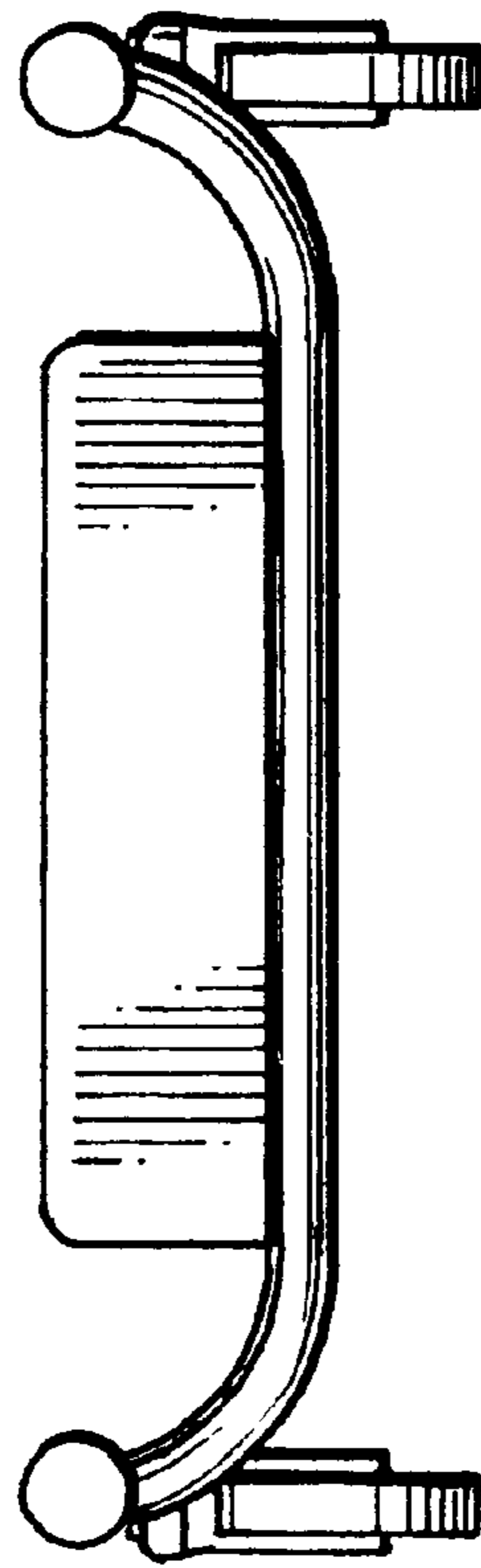

FIG. 6

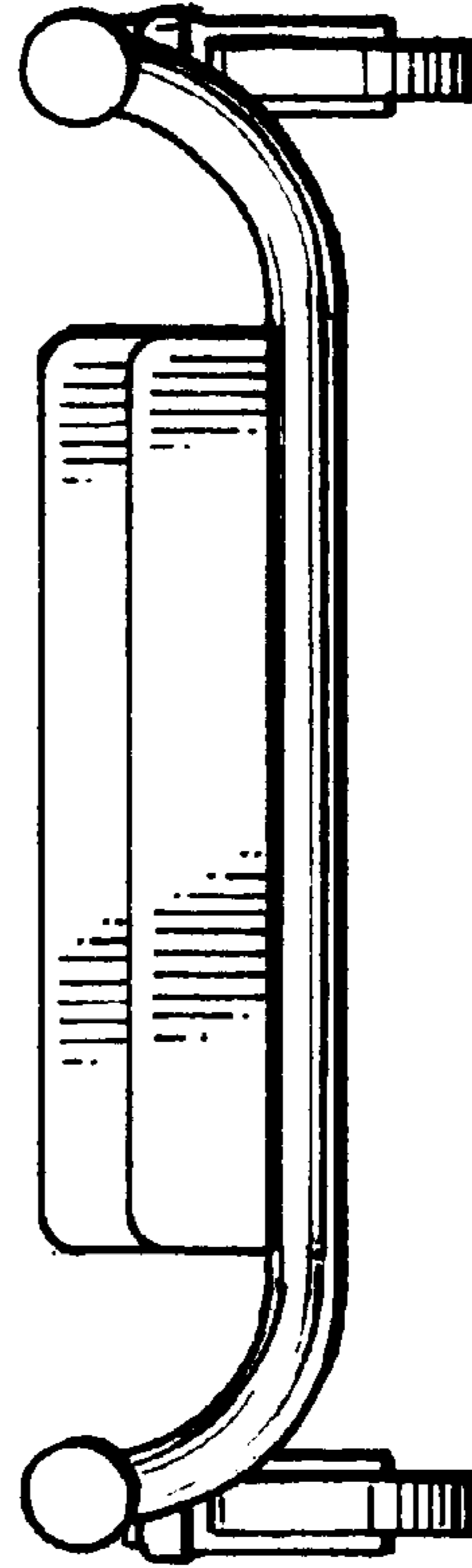

FIG. 5