

US00D522701S

(12) **United States Design Patent**
Scheifele et al.

(10) **Patent No.:** **US D522,701 S**
(45) **Date of Patent:** **** Jun. 6, 2006**

(54) **TANK FOR A FLOOR CARE APPLIANCE**

(75) Inventors: **Kevin E. Scheifele**, Tallmadge, OH (US); **Jeffrey S. Louis**, Green, OH (US); **Ryan R. Berger**, Columbus, OH (US); **Ryan S. Crisp**, Lewis Center, OH (US); **Jeffrey T. DeBord**, Worthington, OH (US); **Douglas G. Schaefer**, Columbus, OH (US); **Oren Shal**, Westerville, OH (US)

(73) Assignee: **The Hoover Company**, North Canton, OH (US)

(**) Term: **14 Years**

(21) Appl. No.: **29/214,444**

(22) Filed: **Oct. 1, 2004**

(51) **LOC (8) Cl.** **15-05**

(52) **U.S. Cl.** **D32/25**

(58) **Field of Classification Search** D32/25,
D32/32, 15, 17, 30, 16, 19, 33, 34, 18, 21,
D32/22, 31, 23, 24; 15/321, 323, 353
See application file for complete search history.

(56) **References Cited**

U.S. PATENT DOCUMENTS

D358,241 S * 5/1995 Bradd D32/22
D361,180 S * 8/1995 Van Der Zwan et al. D32/30

D439,381 S * 3/2001 Saunders et al. D32/31
D442,344 S * 5/2001 Alford et al. D32/31
D446,614 S * 8/2001 Alford et al. D32/30
D450,411 S * 11/2001 Paterson et al. D32/31
D460,229 S * 7/2002 Zahuranec et al. D32/31
D473,357 S * 4/2003 Stephens D32/31

* cited by examiner

Primary Examiner—Louis S. Zarfaz

Assistant Examiner—Kathleen Sims

(74) *Attorney, Agent, or Firm*—A. Burgess Lowe

(57) **CLAIM**

The ornamental design for a tank for a floor care appliance, as shown and described.

DESCRIPTION

FIG. 1 is a front elevational view of a tank in the installed position in a floor care appliance shown in dashed lines showing our new design;

FIG. 2 is a front perspective view of a tank for a floor care appliance;

FIG. 3 is a front view thereof;

FIG. 4 is a top view thereof;

FIG. 5 is a rear view thereof; and,

FIG. 6 is a left side view thereof, the right side view being a mirror image.

The portion of the drawing shown in dashed lines is for illustrative purposes only.

1 Claim, 4 Drawing Sheets

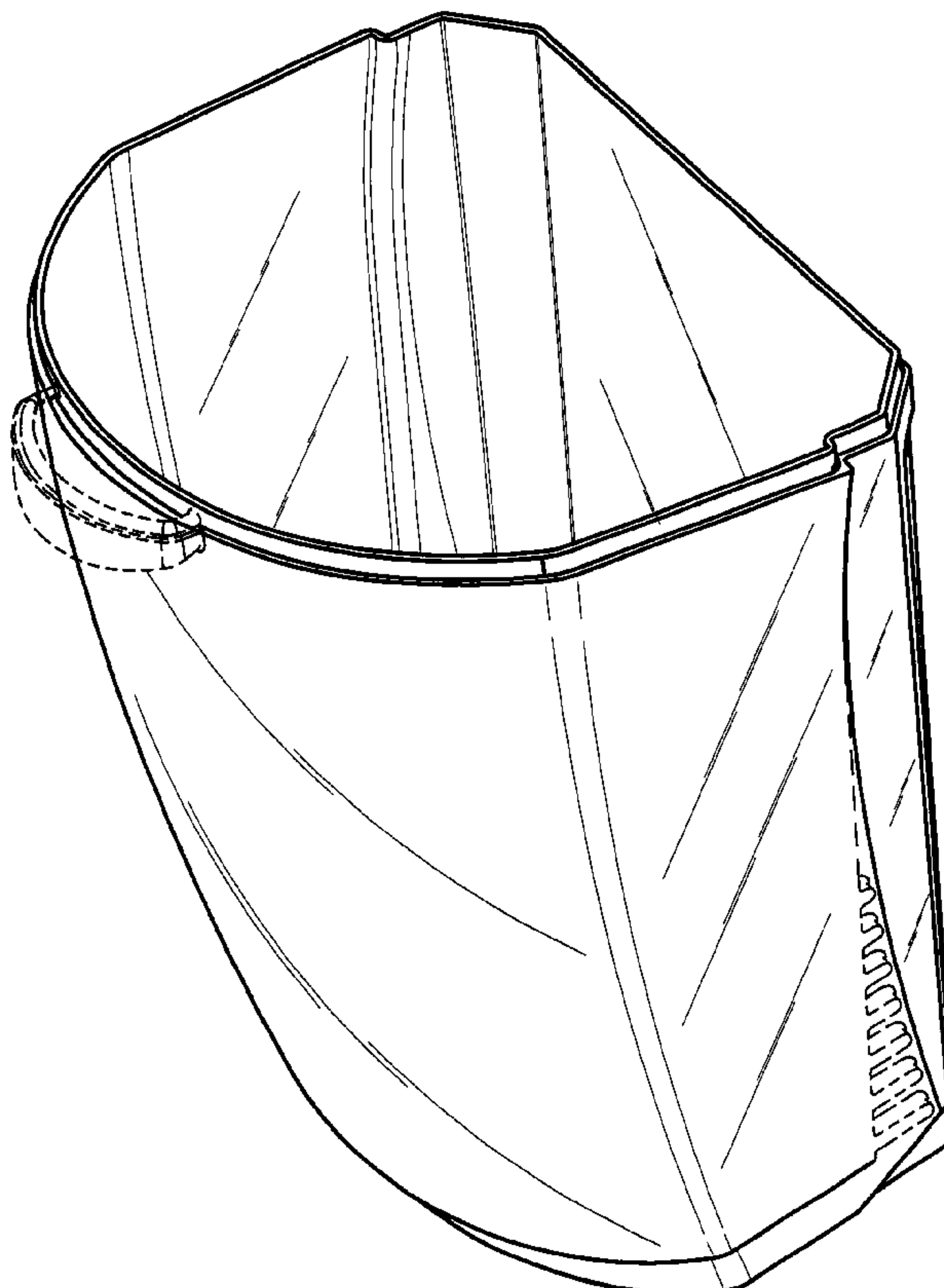

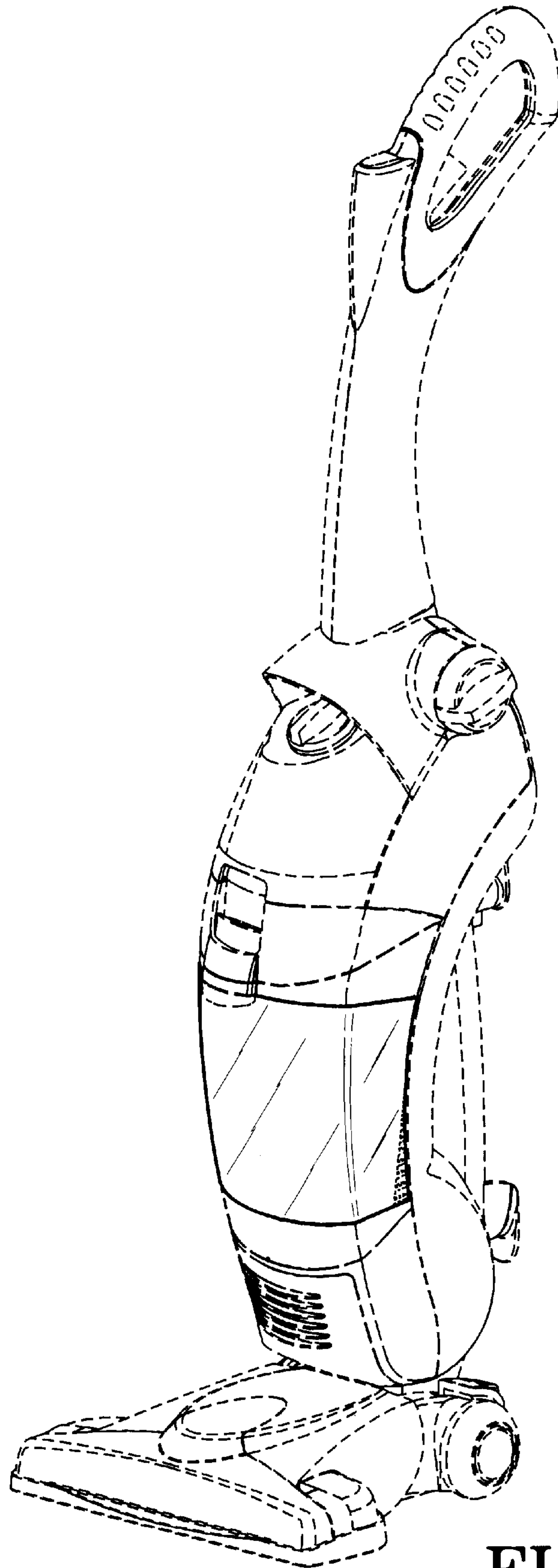

FIG-1

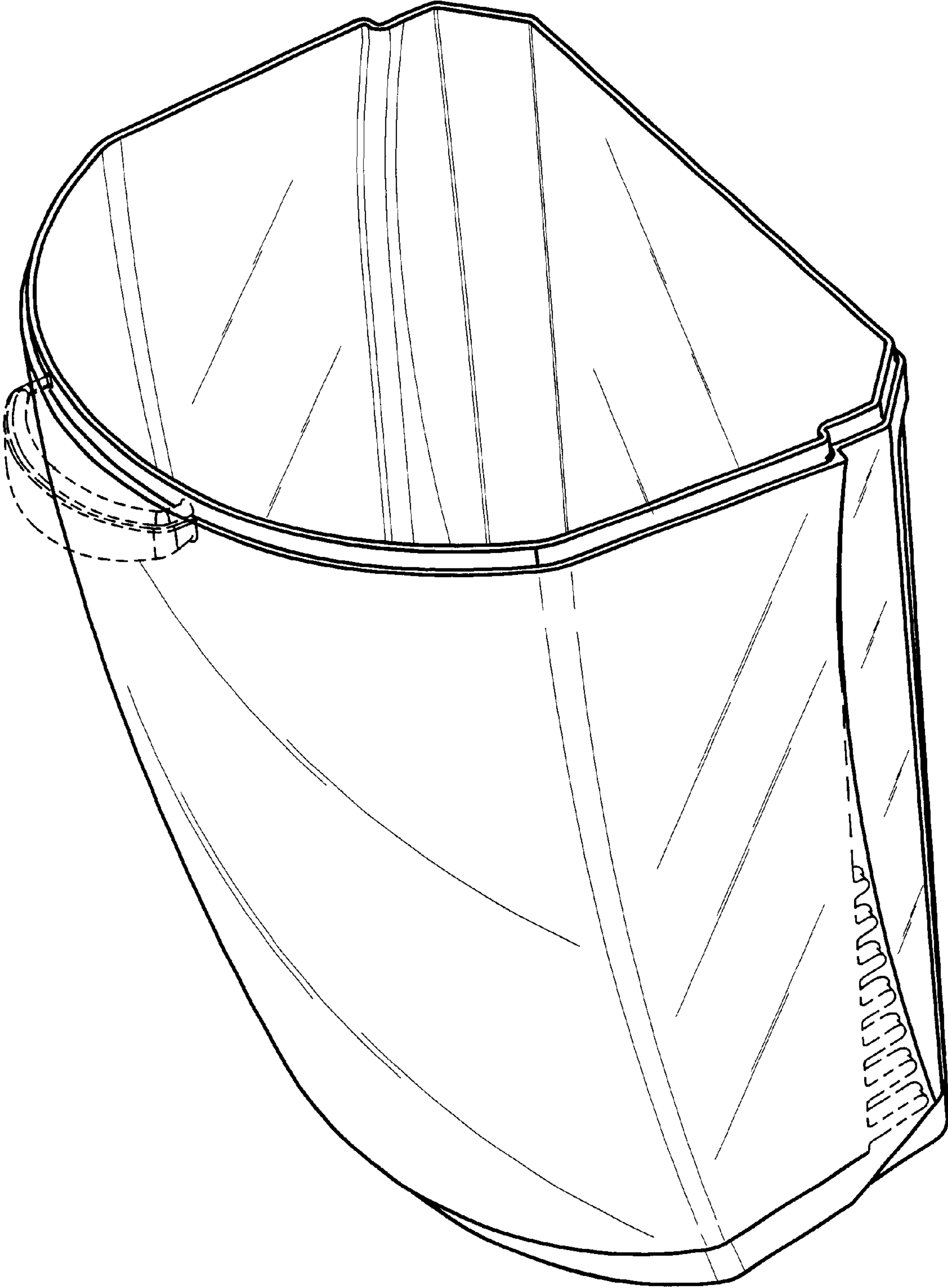

FIG-2

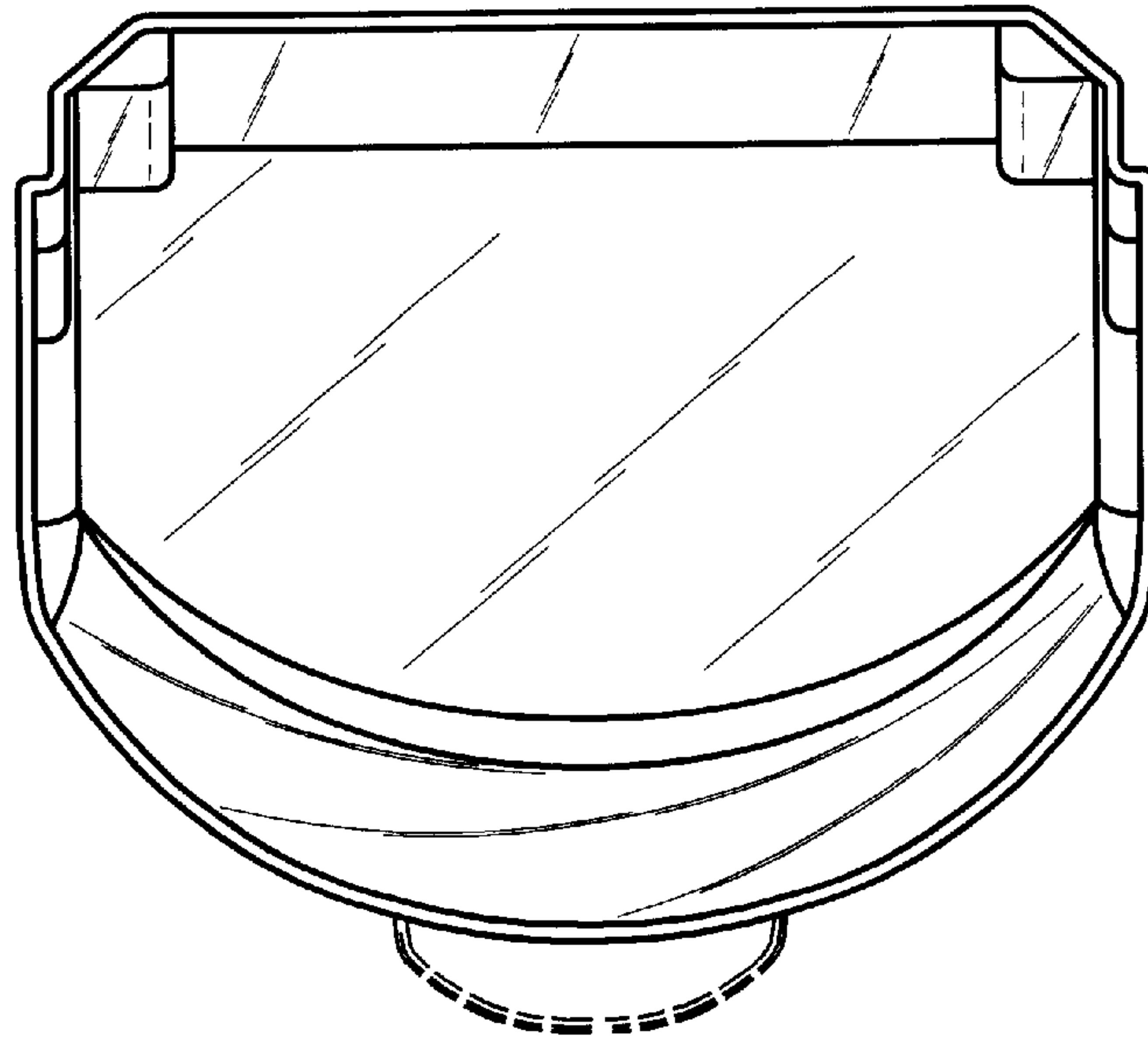

FIG-4

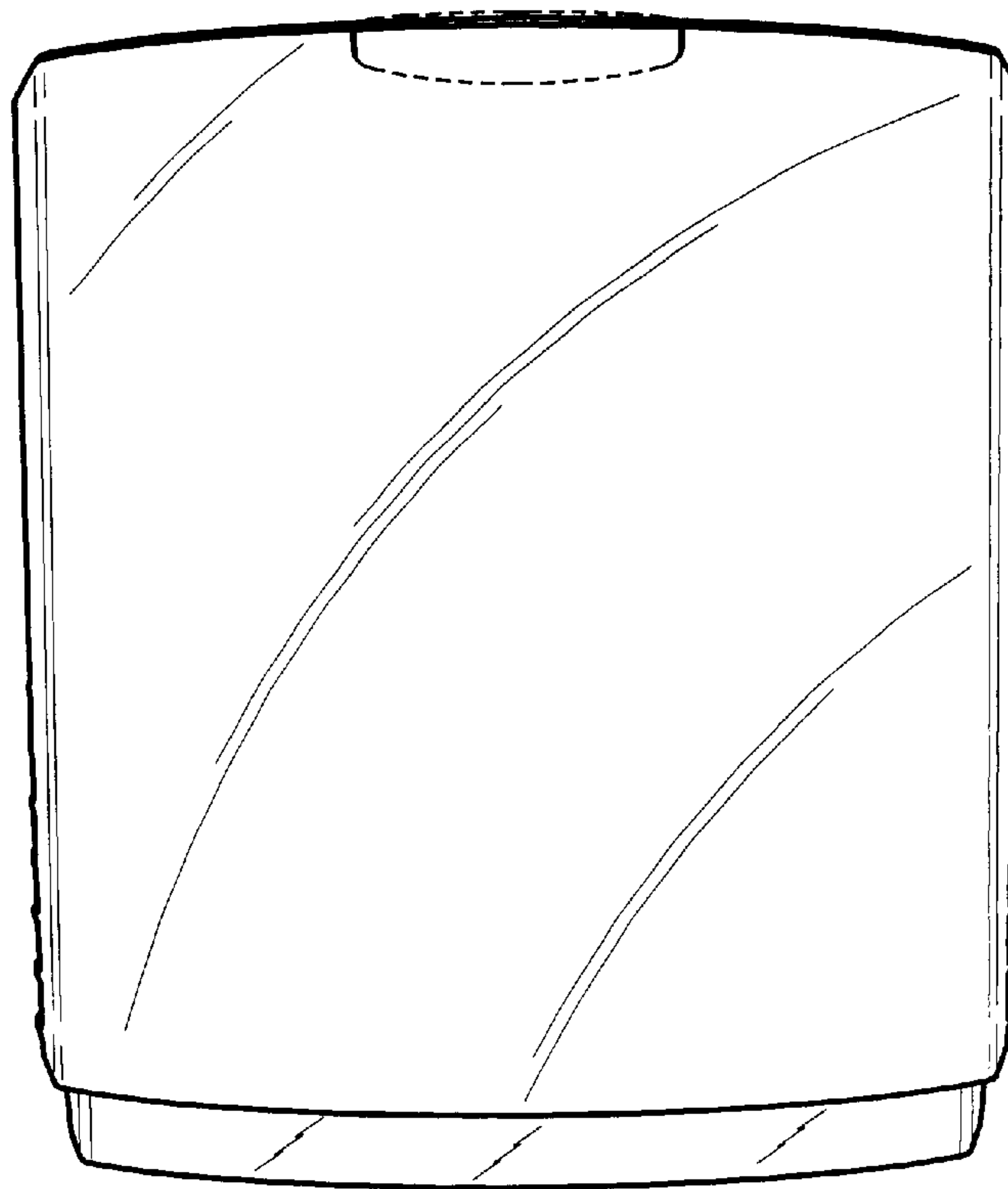

FIG-3

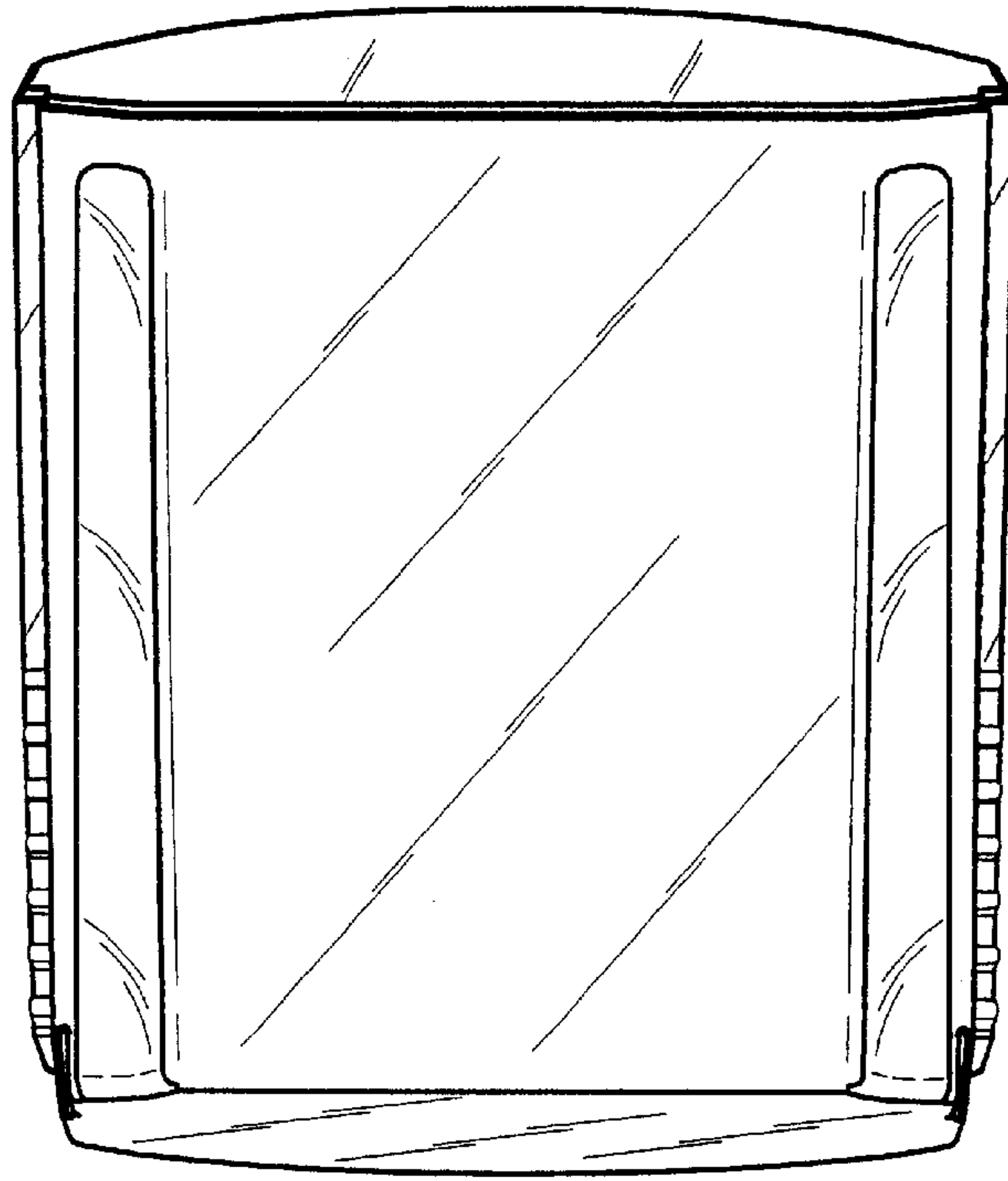

FIG-5

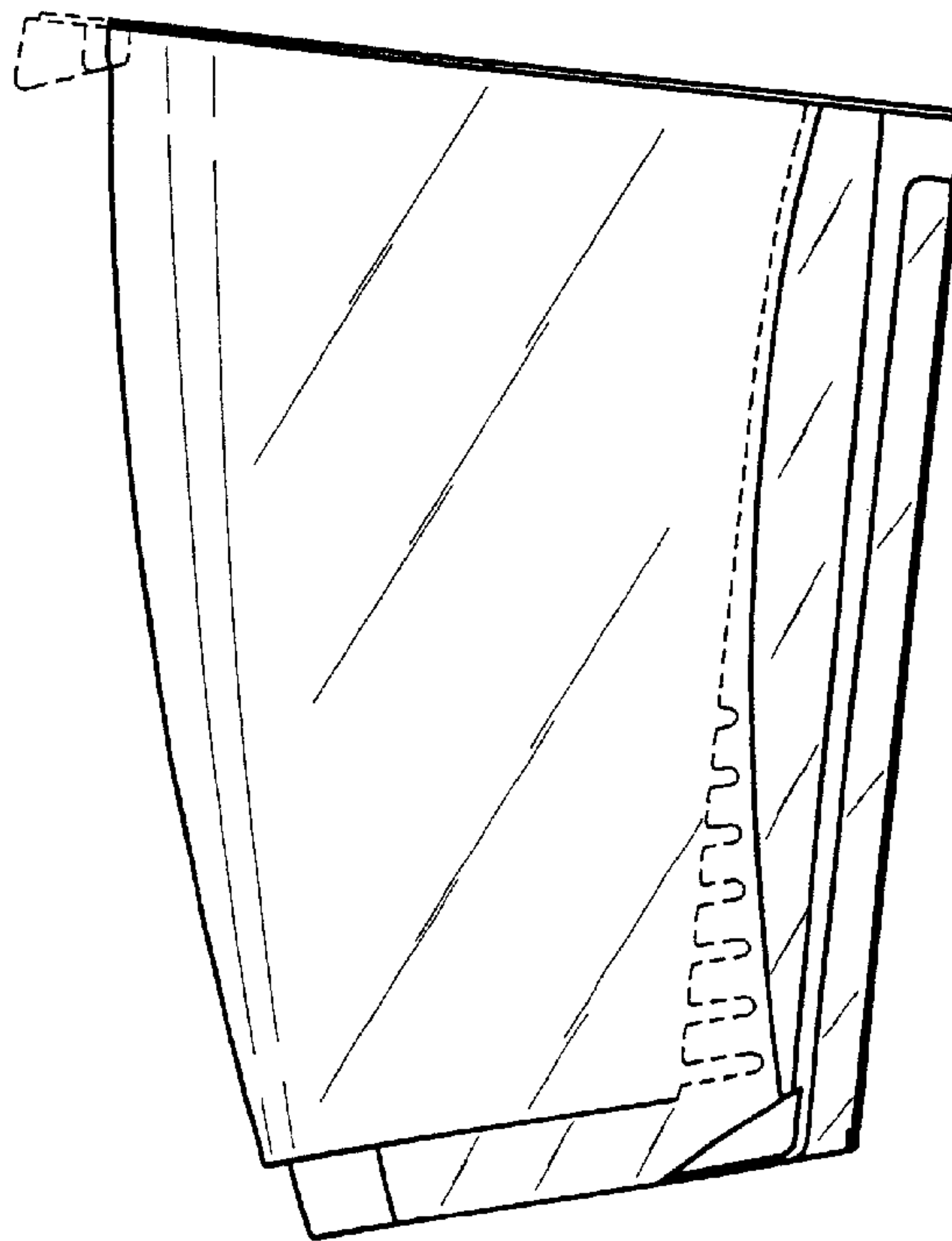

FIG-6