



US00D522700S

(12) **United States Design Patent**
Rademeyer

(10) **Patent No.:** **US D522,700 S**
(45) **Date of Patent:** **** Jun. 6, 2006**

(54) **SWIMMING POOL CLEANER BODY**

(75) Inventor: **Claire Liese Rademeyer**, Johannesburg (ZA)

(73) Assignee: **Mocani (Proprietary) Limited**, Randburg (ZA)

(**) Term: **14 Years**

(21) Appl. No.: **29/222,912**

(22) Filed: **Feb. 7, 2005**

(51) **LOC (8) Cl.** **15-05**

(52) **U.S. Cl.** **D32/15**

(58) **Field of Classification Search** D32/21,
D32/22, 28, 15, 16, 19, 17, 20, 25, 31, 33,
D32/34, 1; D8/61, 62; 210/169, 416.2; 15/1.7;
55/373, 374

See application file for complete search history.

(56) **References Cited**

U.S. PATENT DOCUMENTS

D325,796 S	*	4/1992	Kallenbach	D32/1
D346,888 S	*	5/1994	Stone	D32/1
D430,364 S	*	8/2000	Supra	D32/1
D485,652 S	*	1/2004	Erlich	D32/21
D487,826 S	*	3/2004	Supra	D32/25
2002/0166185 A1	*	11/2002	Balint	15/1.7
2003/0019056 A1	*	1/2003	Kallenbach	15/1.7

2005/0035039 A1 * 2/2005 Erlich 210/169

* cited by examiner

Primary Examiner—Louis S. Zarfes

Assistant Examiner—Kathleen Sims

(74) *Attorney, Agent, or Firm*—Young & Thompson

(57) **CLAIM**

The ornamental design for a swimming pool cleaner body, as shown and described.

DESCRIPTION

FIG. 1 is a perspective view of a first embodiment of the swimming pool cleaner body of the invention;

FIG. 2 is a left side view;

FIG. 3 is an under plan view;

FIG. 4 is a view of one end;

FIG. 5 is a plan view;

FIG. 6 is a right side view;

FIG. 7 is a view of an opposing end;

FIG. 8 is a perspective view of a second embodiment of the swimming pool cleaner body of the invention;

FIG. 9 is a left side view;

FIG. 10 is an under plan view;

FIG. 11 is a view of one end;

FIG. 12 is a plan view;

FIG. 13 is a right side view; and,

FIG. 14 is a view of an opposing end.

1 Claim, 6 Drawing Sheets

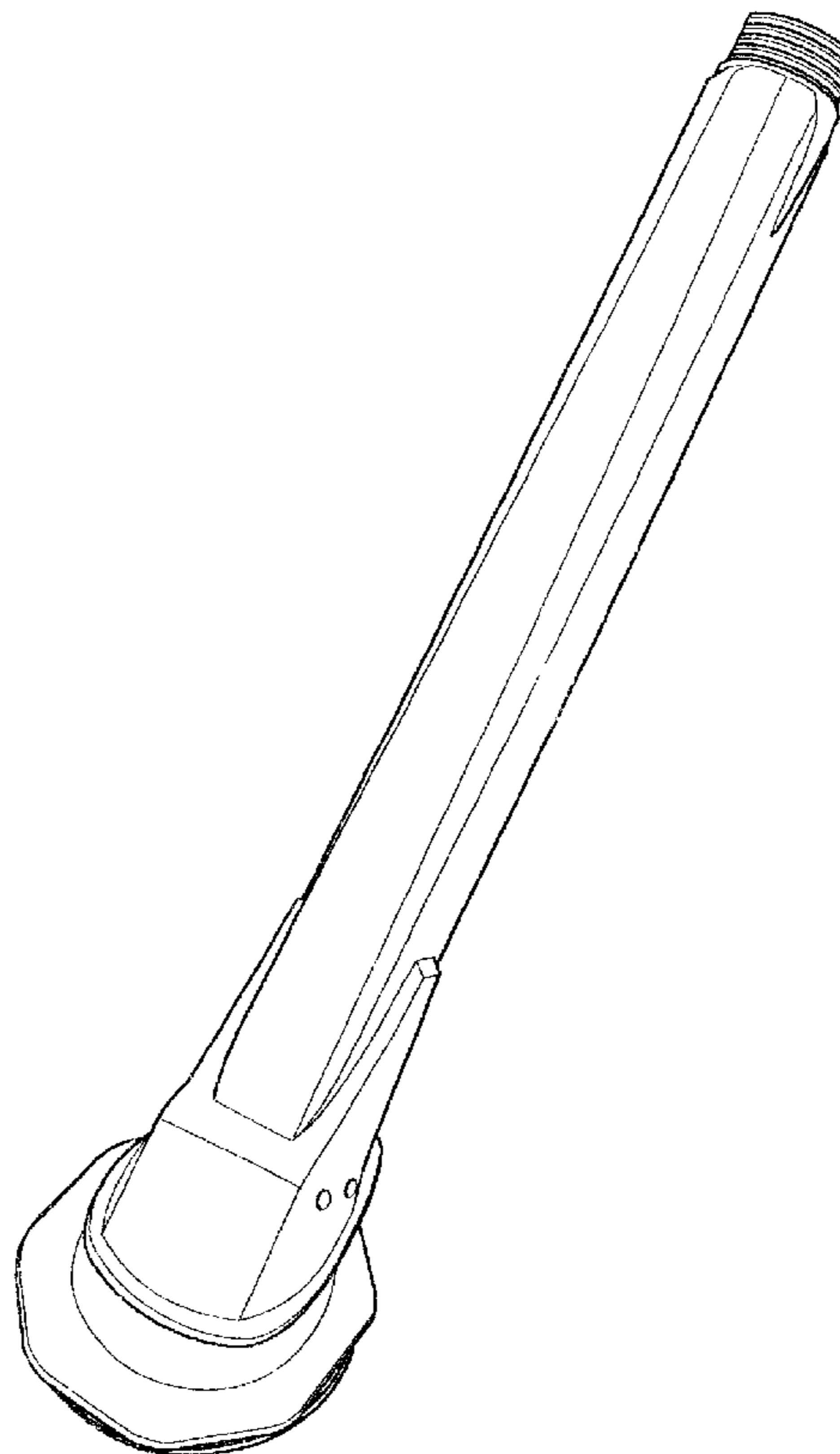
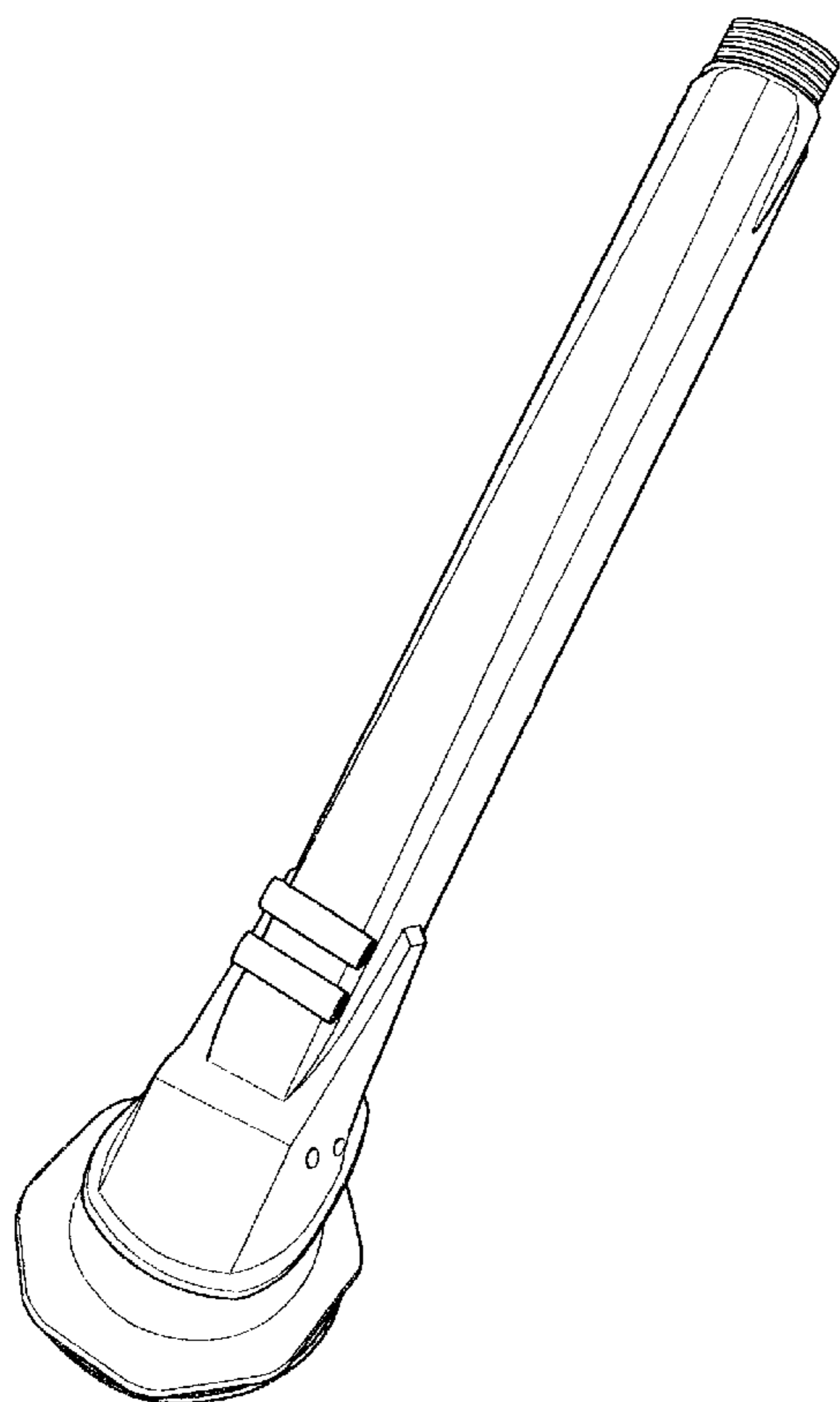

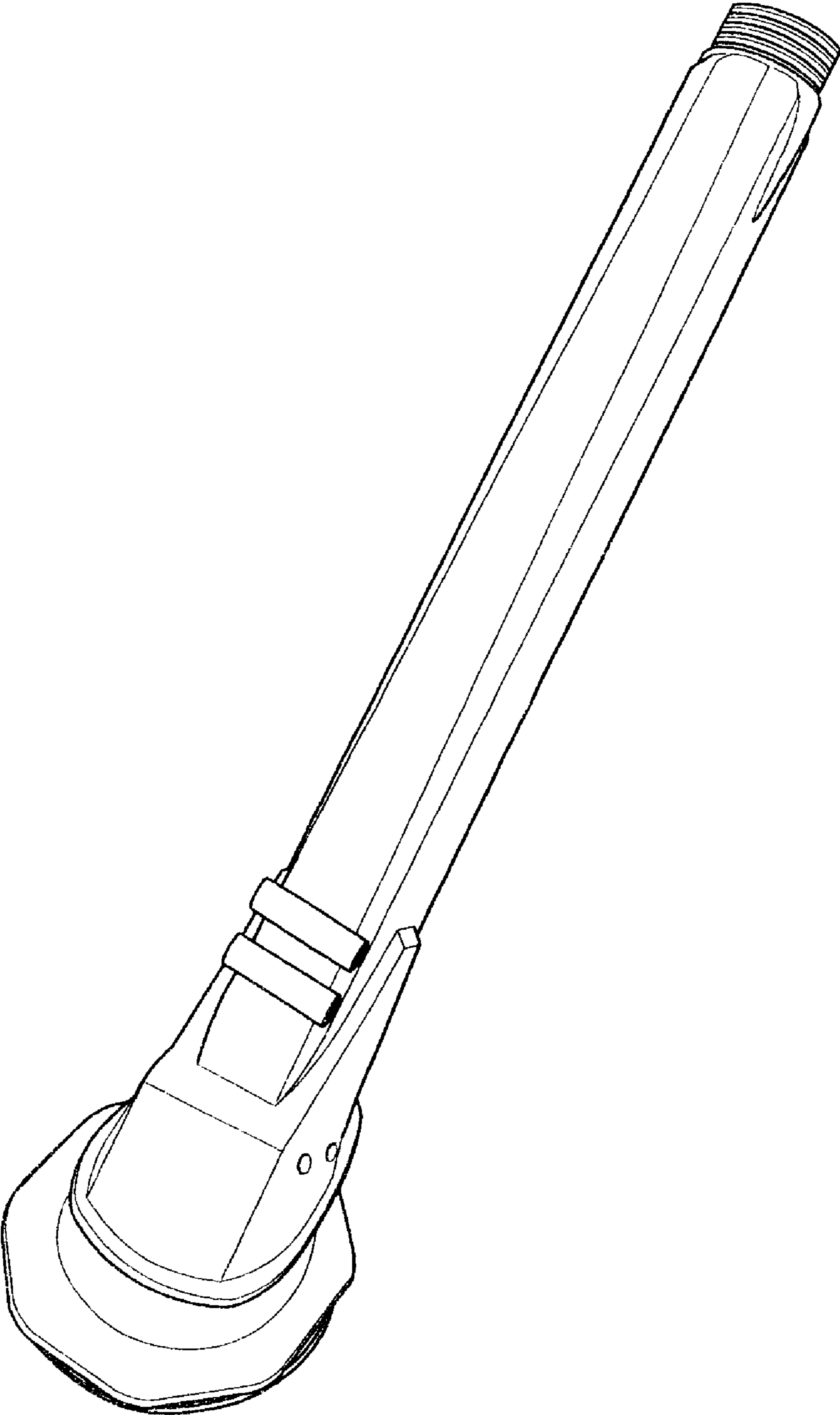

Figure 1

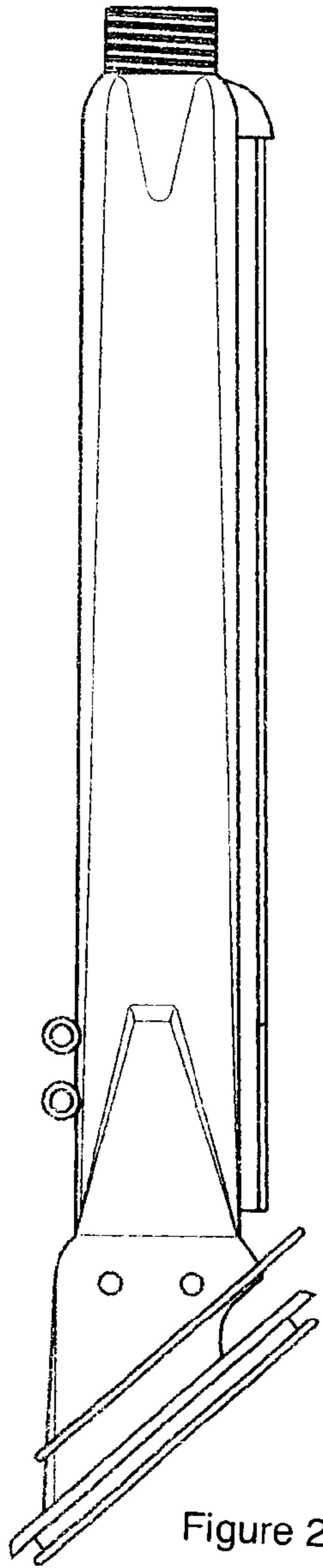

Figure 2

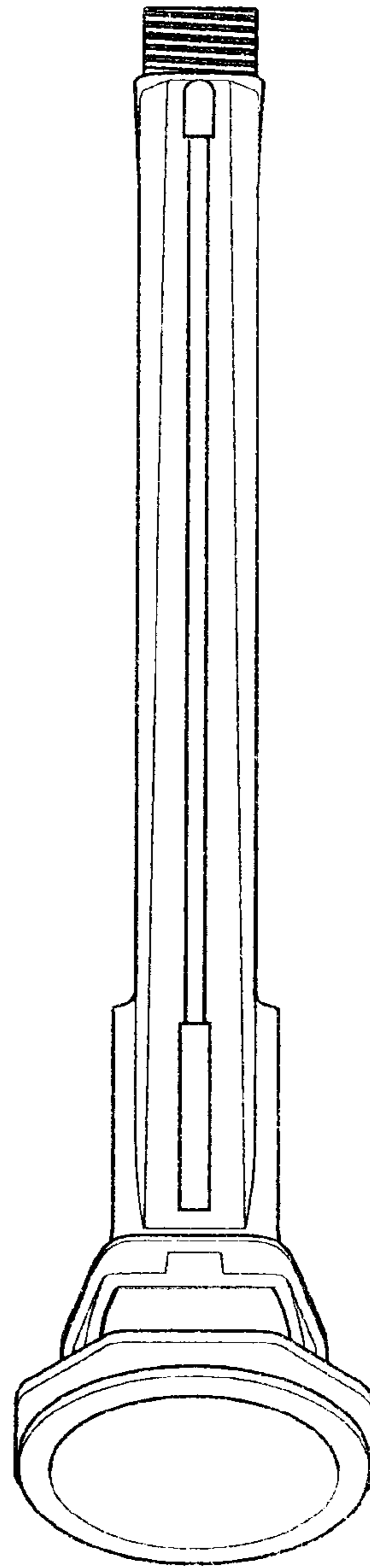

Figure 3

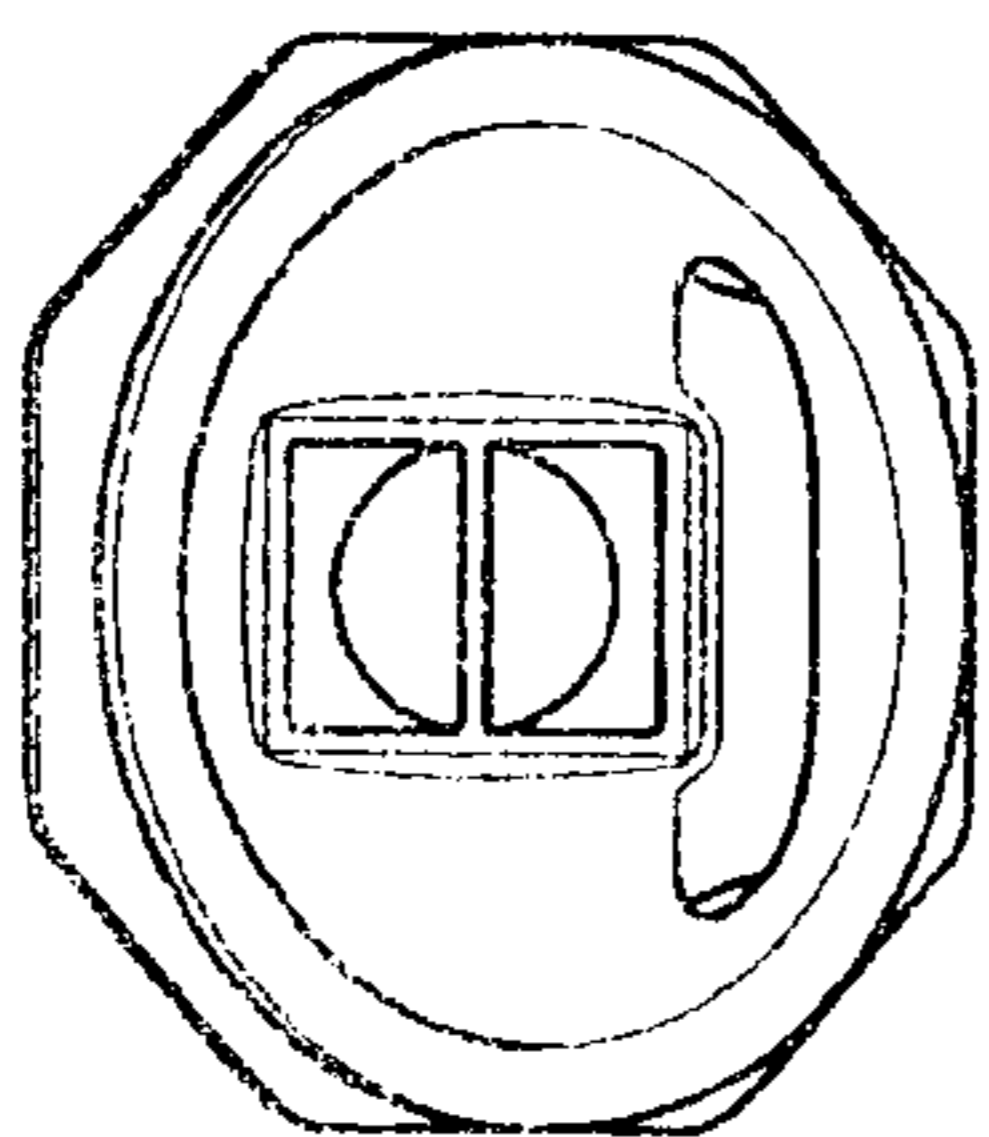

Figure 4

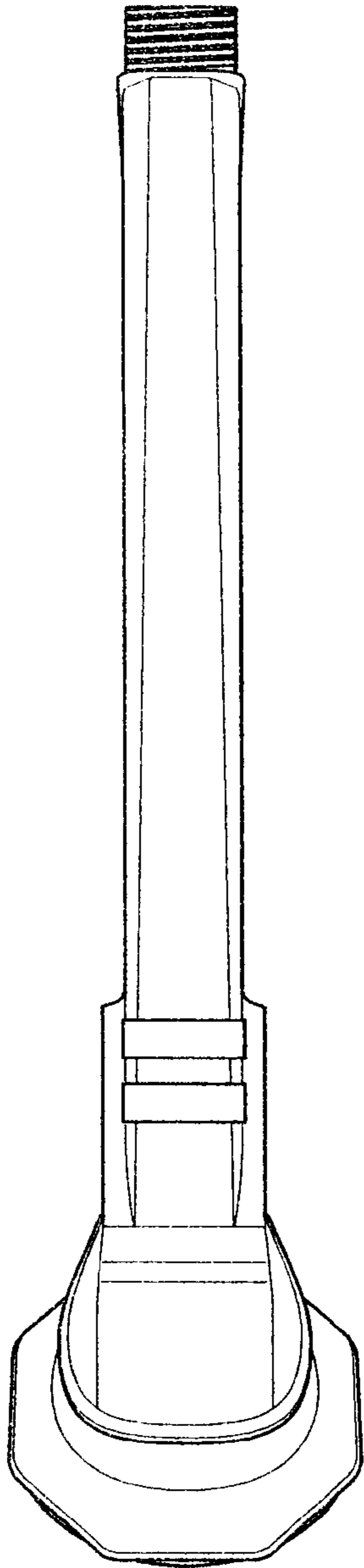

Figure 5

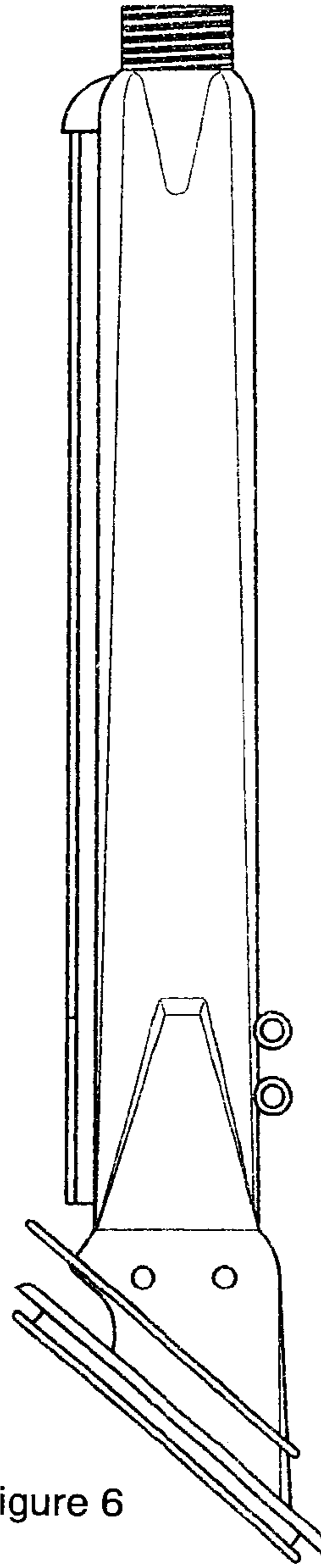

Figure 6

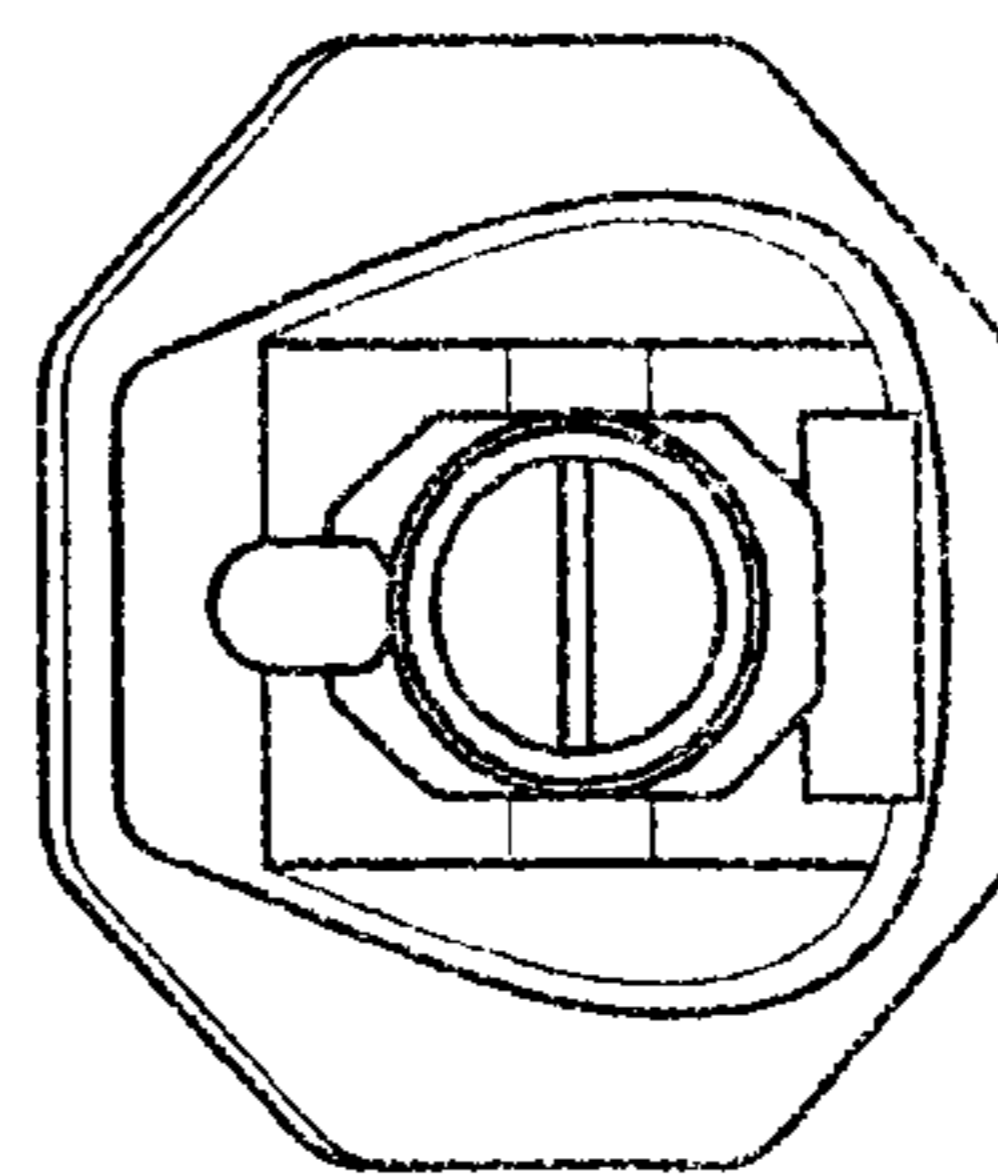

Figure 7

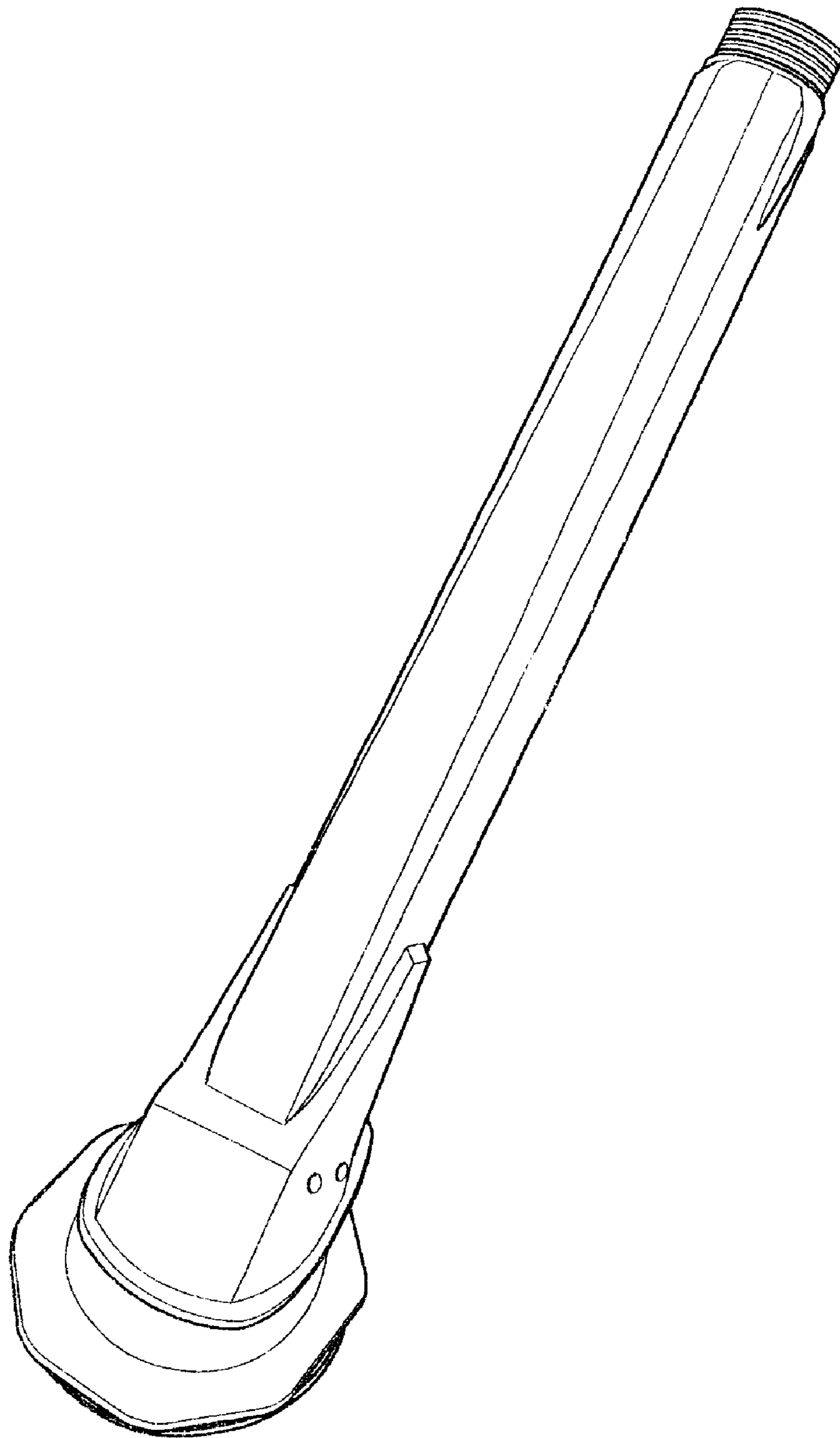

Figure 8

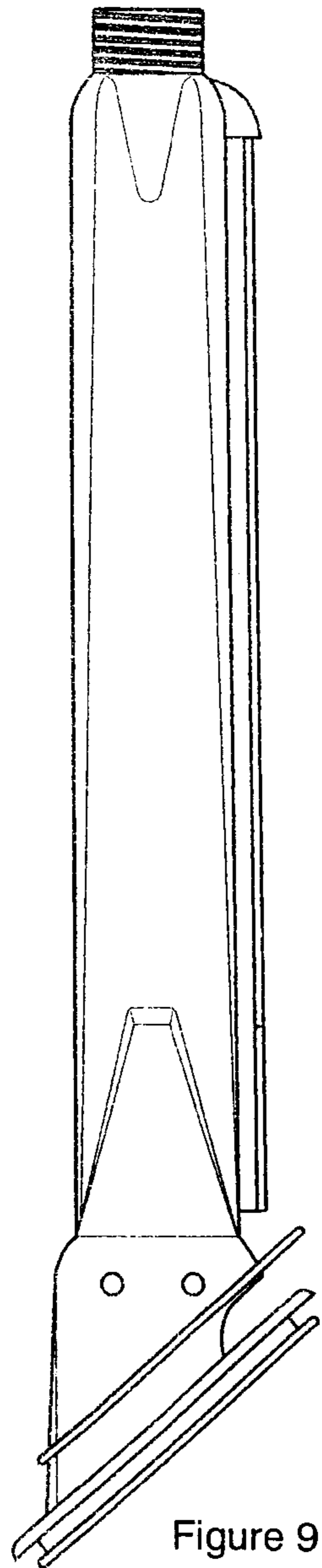

Figure 9

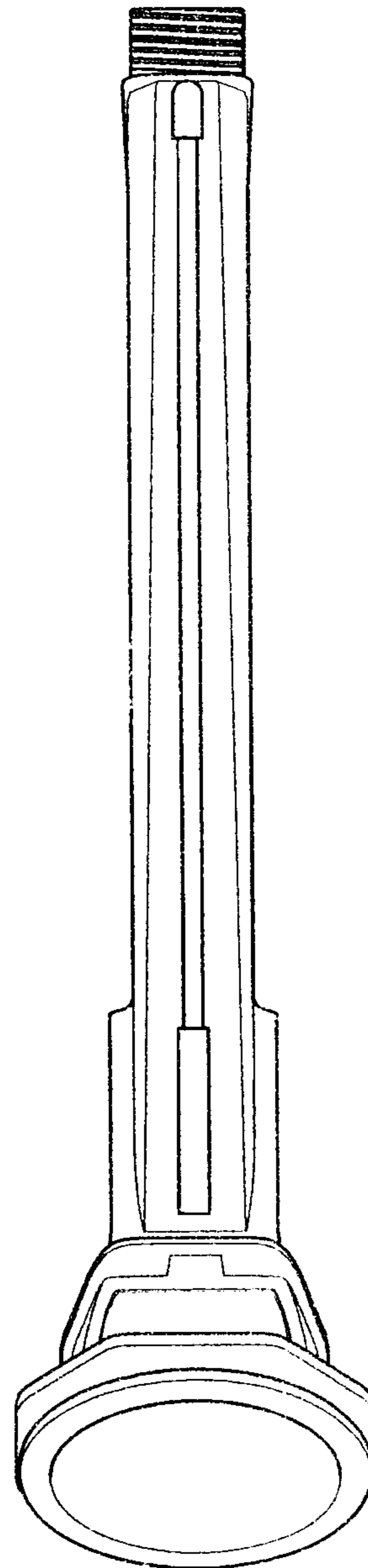

Figure 10

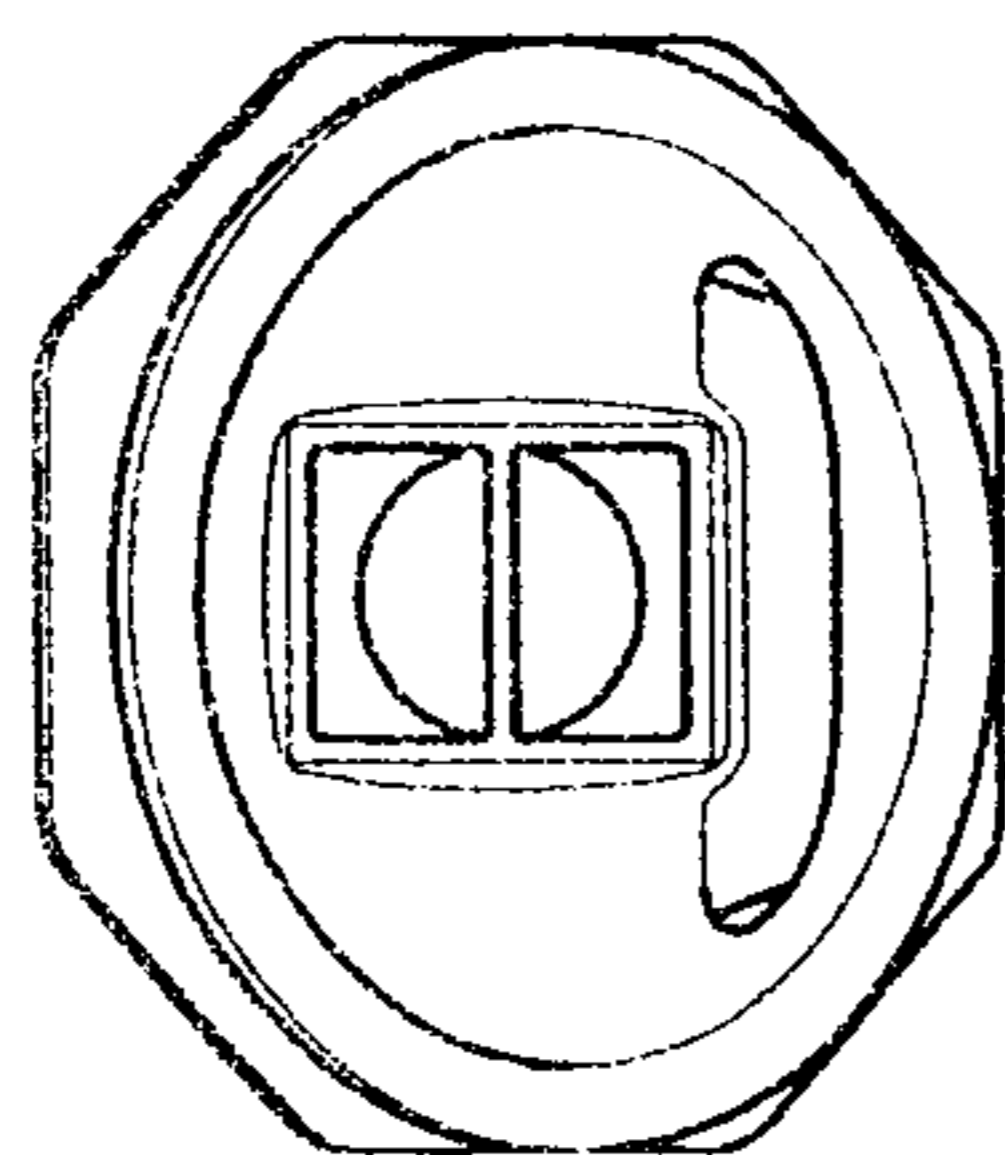

Figure 11

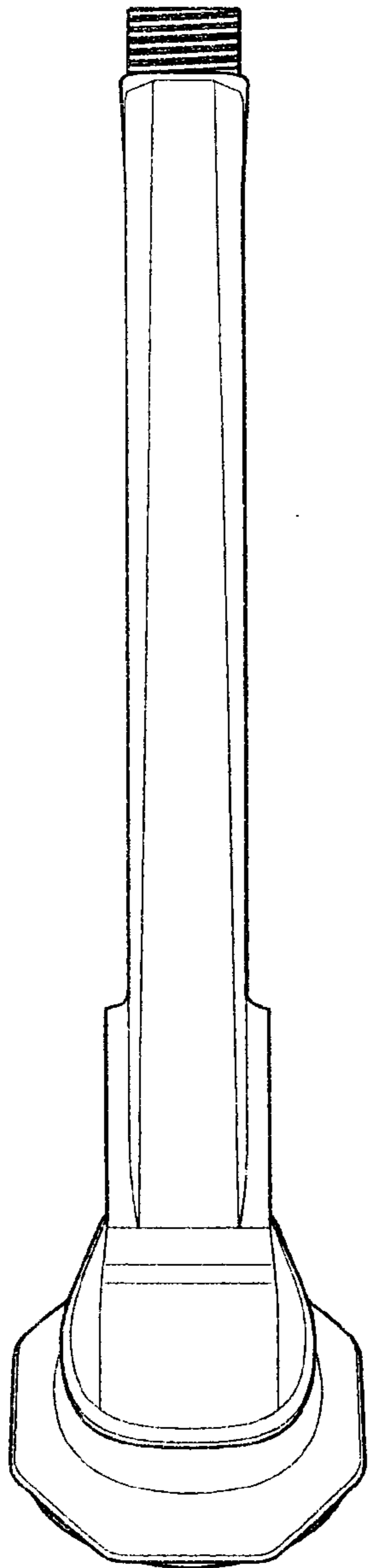

Figure 12

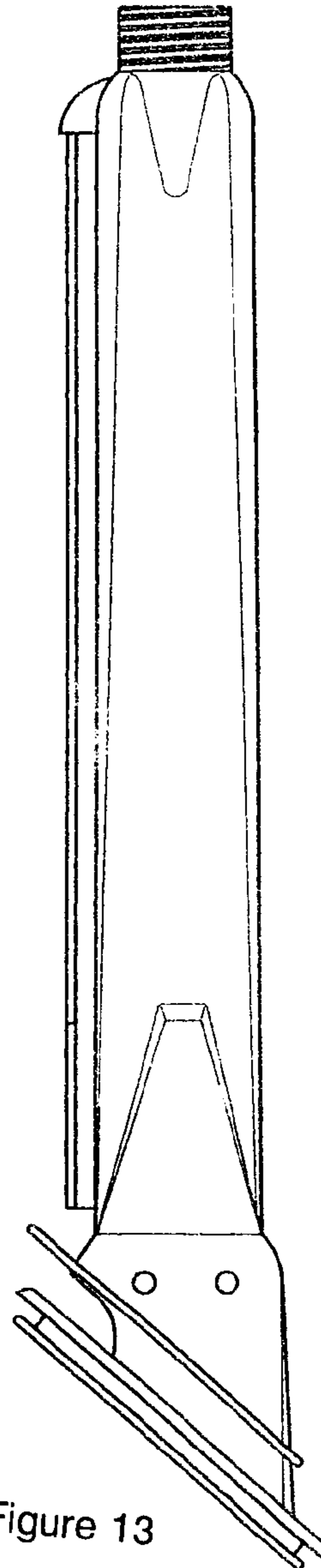

Figure 13

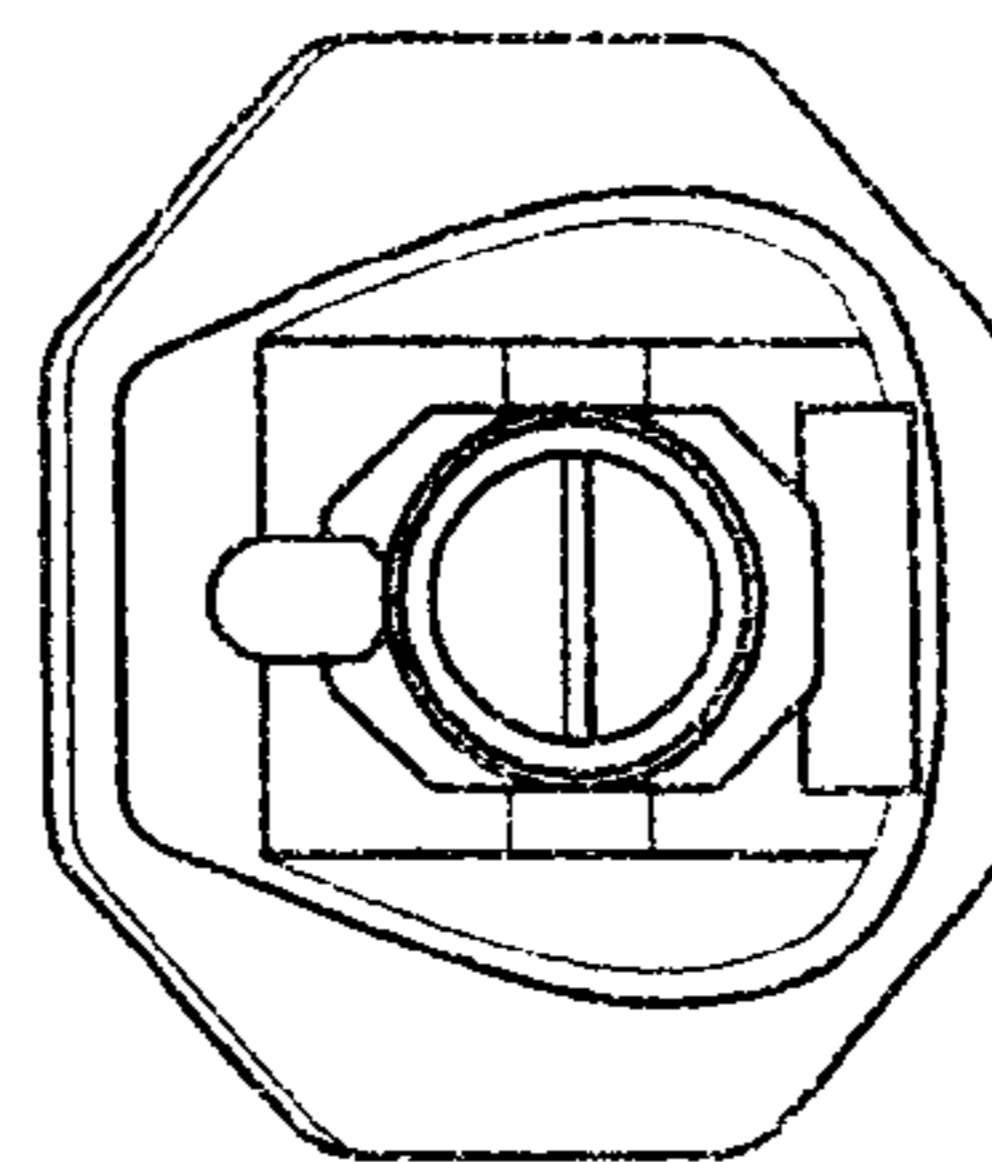

Figure 14