



US00D522686S

(12) **United States Design Patent**
Lee

(10) **Patent No.:** **US D522,686 S**
(45) **Date of Patent:** **** Jun. 6, 2006**

(54) **PORTION OF A LIGHTING FIXTURE**

(76) Inventor: **Ying-Jue Lee**, 3F, No. 10, Alley 16,
Lane 205, Sec. 3, Hsien Ming Da Doa,
Panchou, Taipei Hsien (TW), 220

(**) Term: **14 Years**

(21) Appl. No.: **29/229,983**

(22) Filed: **May 16, 2005**

(51) **LOC (8) Cl.** **26-99**

(52) **U.S. Cl.** **D26/142; D26/138; D26/92**

(58) **Field of Classification Search** D26/72,
D26/80-92, 138, 155, 142-145; 362/147,
362/404-408, 432

See application file for complete search history.

(56) **References Cited**

U.S. PATENT DOCUMENTS

- D391,011 S * 2/1998 Kluck D26/142
- D416,345 S * 11/1999 Palacios D26/81
- D416,640 S * 11/1999 Palacios D26/81
- D482,490 S * 11/2003 Fickas et al. D26/138

OTHER PUBLICATIONS

Calavera "Close To Ceiling" Light. Item #28016 from
bellacor.com. Found online Sep. 23, 2005.*

Brushed Steel 7½" High Wall Sconce, Item # 83844 from
Lampsplus.com. Found online Sep. 21, 2005.*

Kichler Lighting Catalog No. 104 ©2004. Items #76010,
#70052 and #70053 on p. 91.*

Kichler Lighting Catalog No. 104 ©2004. Items #2440,
#2841, #2740 and #2940 on p. 89.*

* cited by examiner

Primary Examiner—Clare E Heflin

(57) **CLAIM**

The ornamental design for a portion of a lighting fixture, as
shown and described.

DESCRIPTION

FIG. 1 is a perspective view of a portion of a lighting fixture
showing my new design;

FIG. 2 is a front elevational view thereof;

FIG. 3 is a rear elevational view thereof;

FIG. 4 is a left side elevational view thereof;

FIG. 5 is a right side elevational view thereof;

FIG. 6 is a top plan view thereof; and

FIG. 7 is a bottom plan view thereof; and,

FIG. 8 is a perspective view thereof when in use.

The broken lines are shown for illustrative purpose only, and
forming no part of the claimed design.

1 Claim, 4 Drawing Sheets

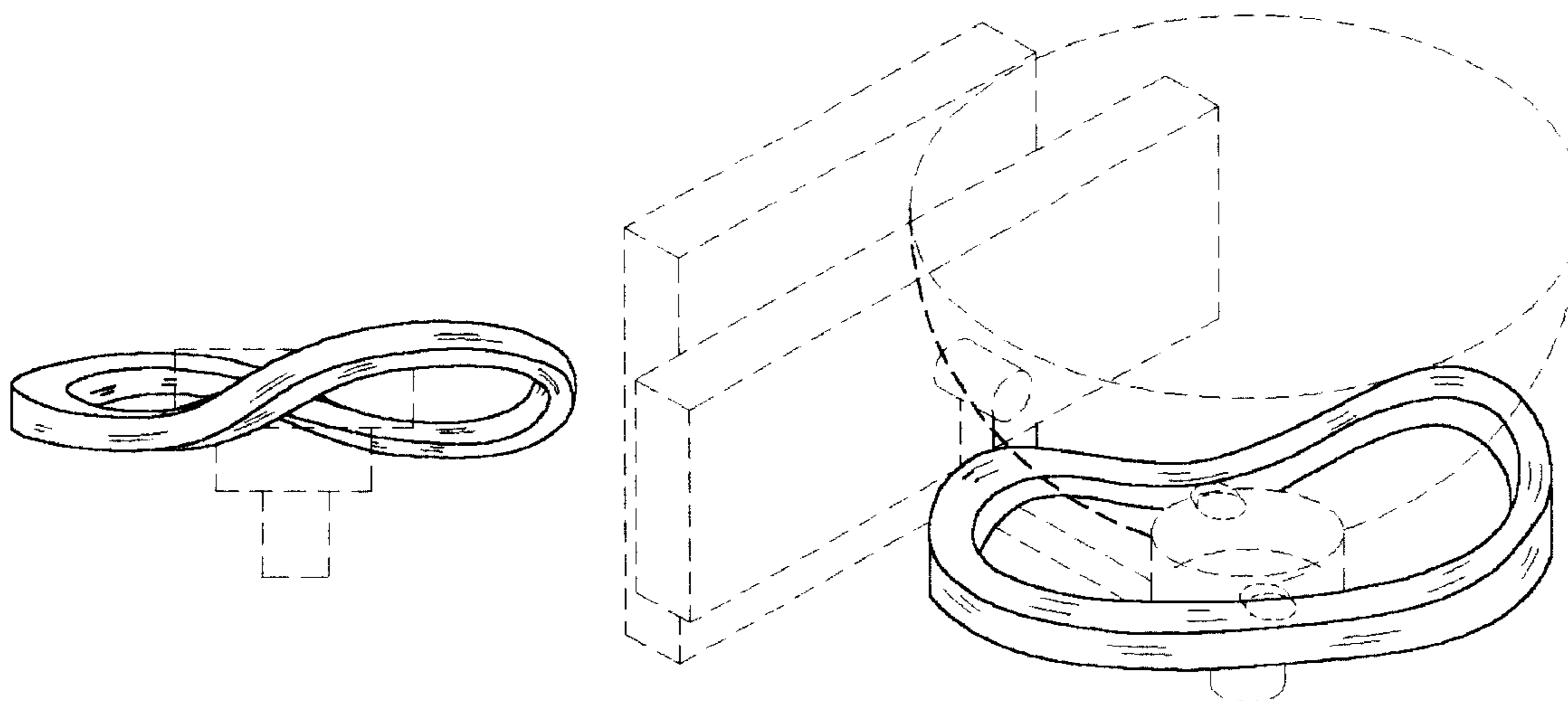

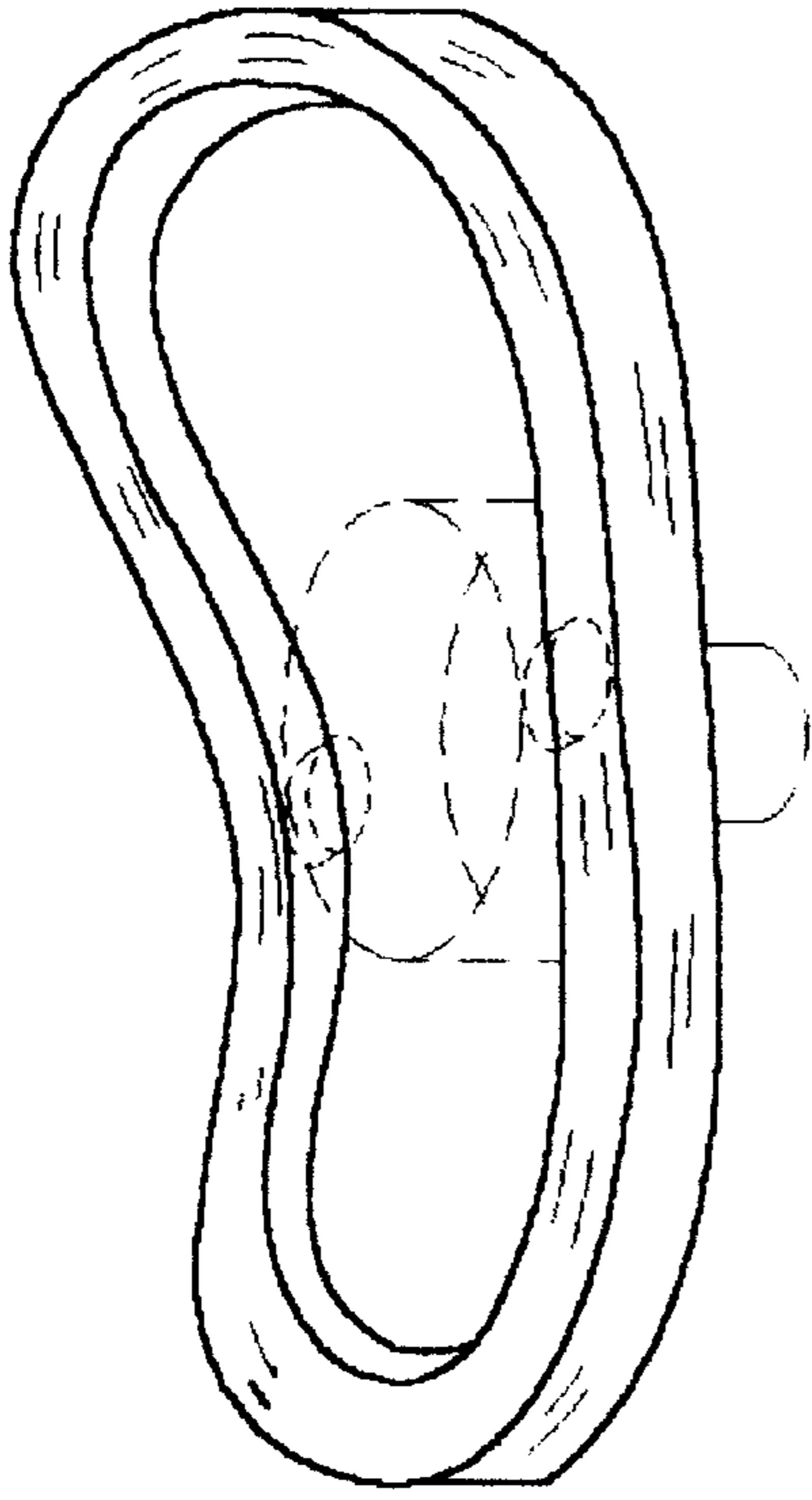

FIG. 1

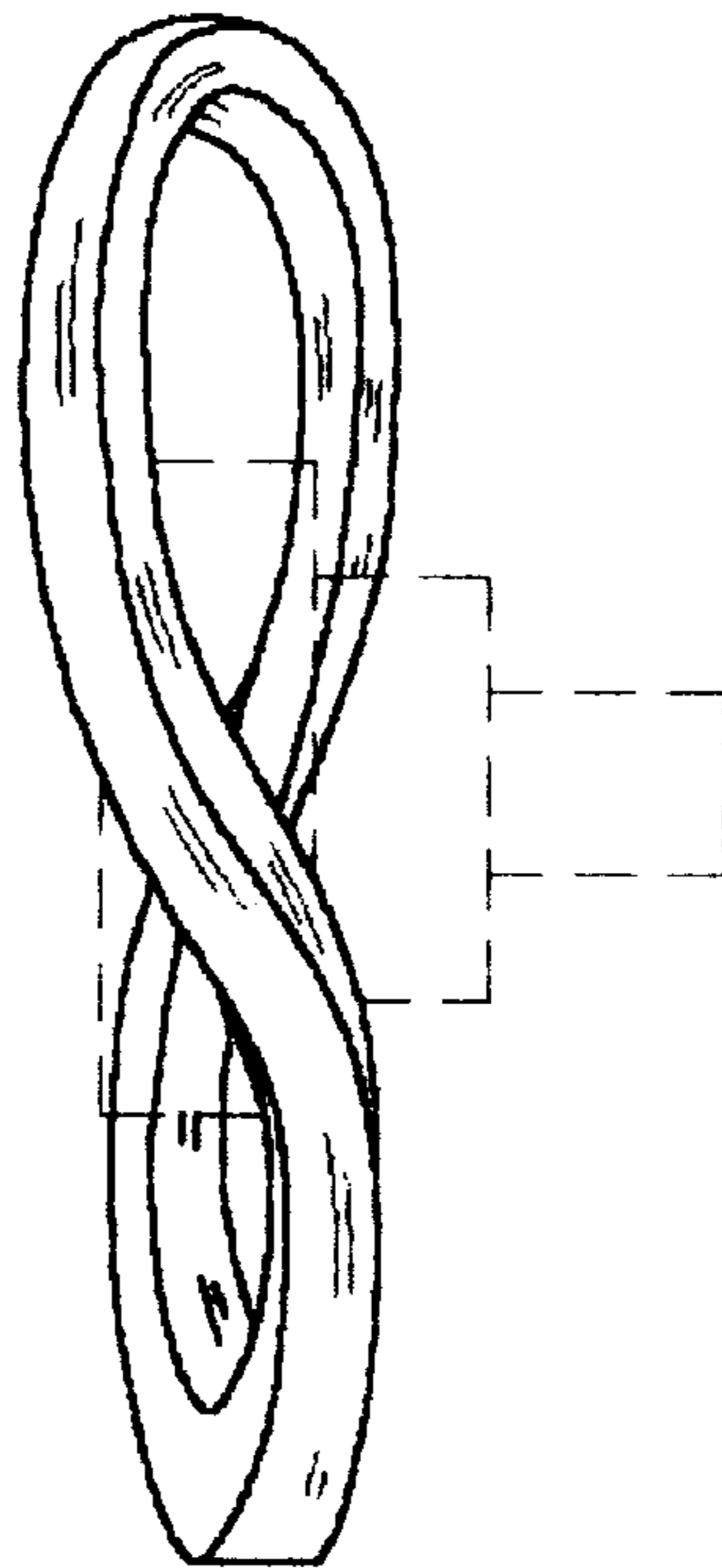

FIG. 2

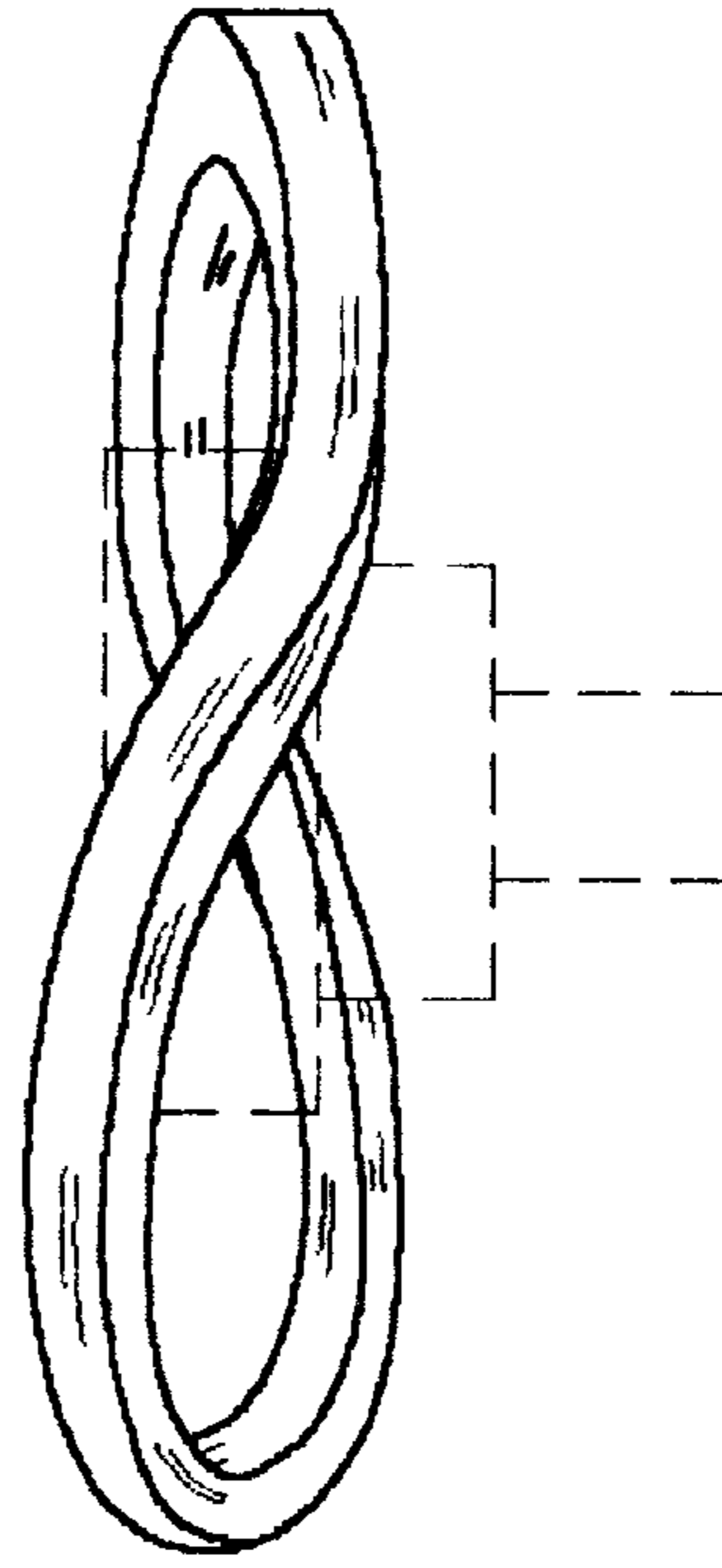

FIG. 3

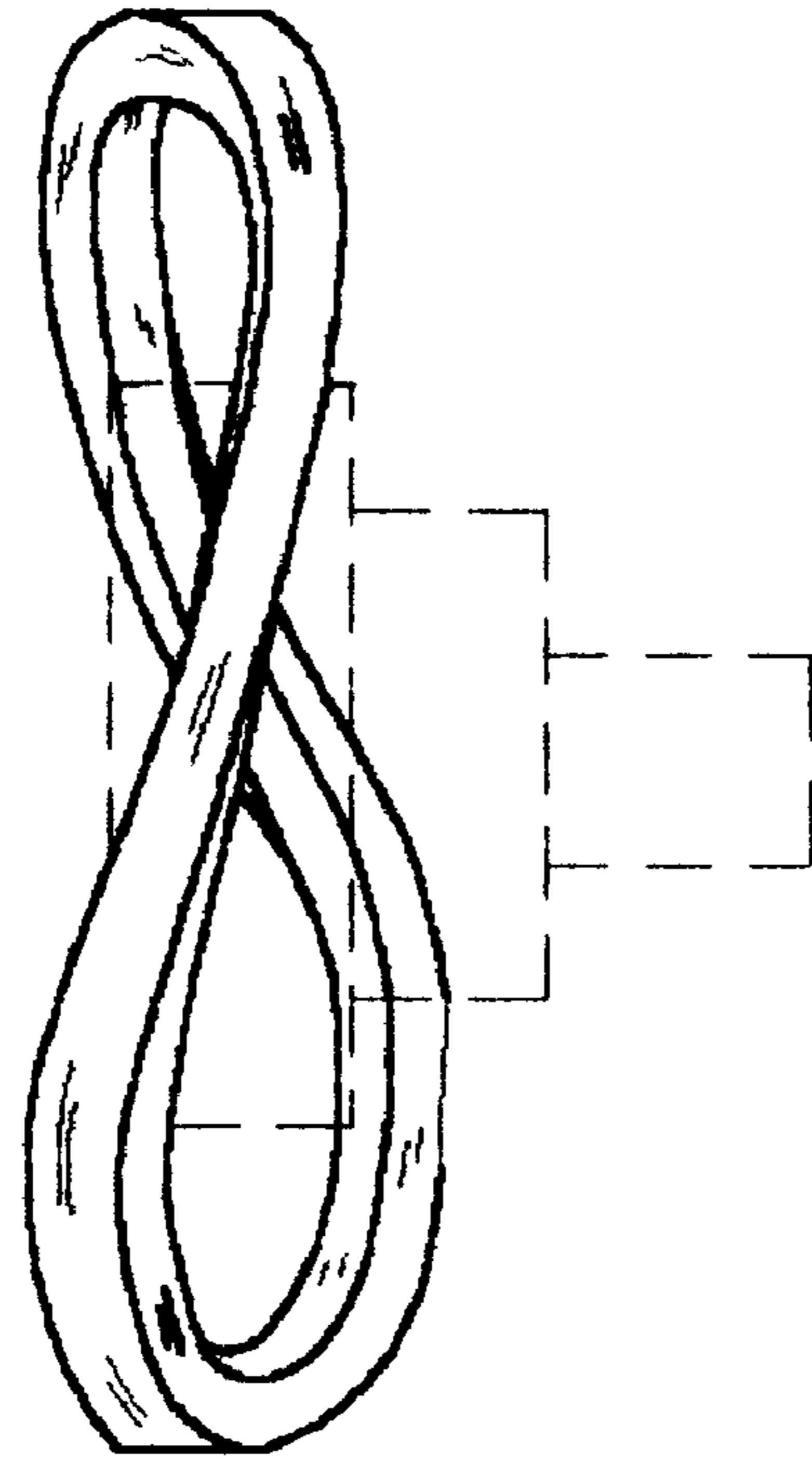

FIG. 4

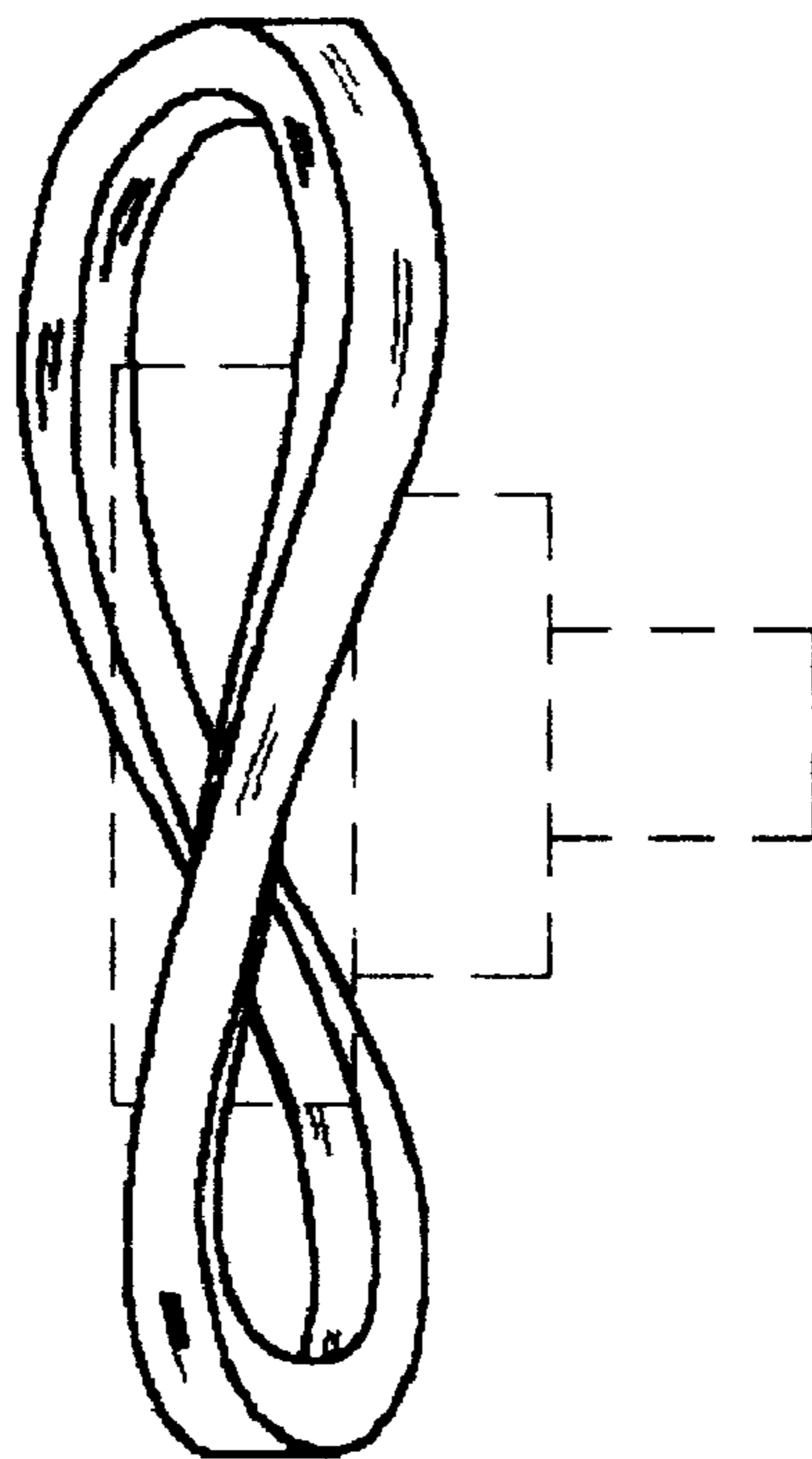

FIG. 5

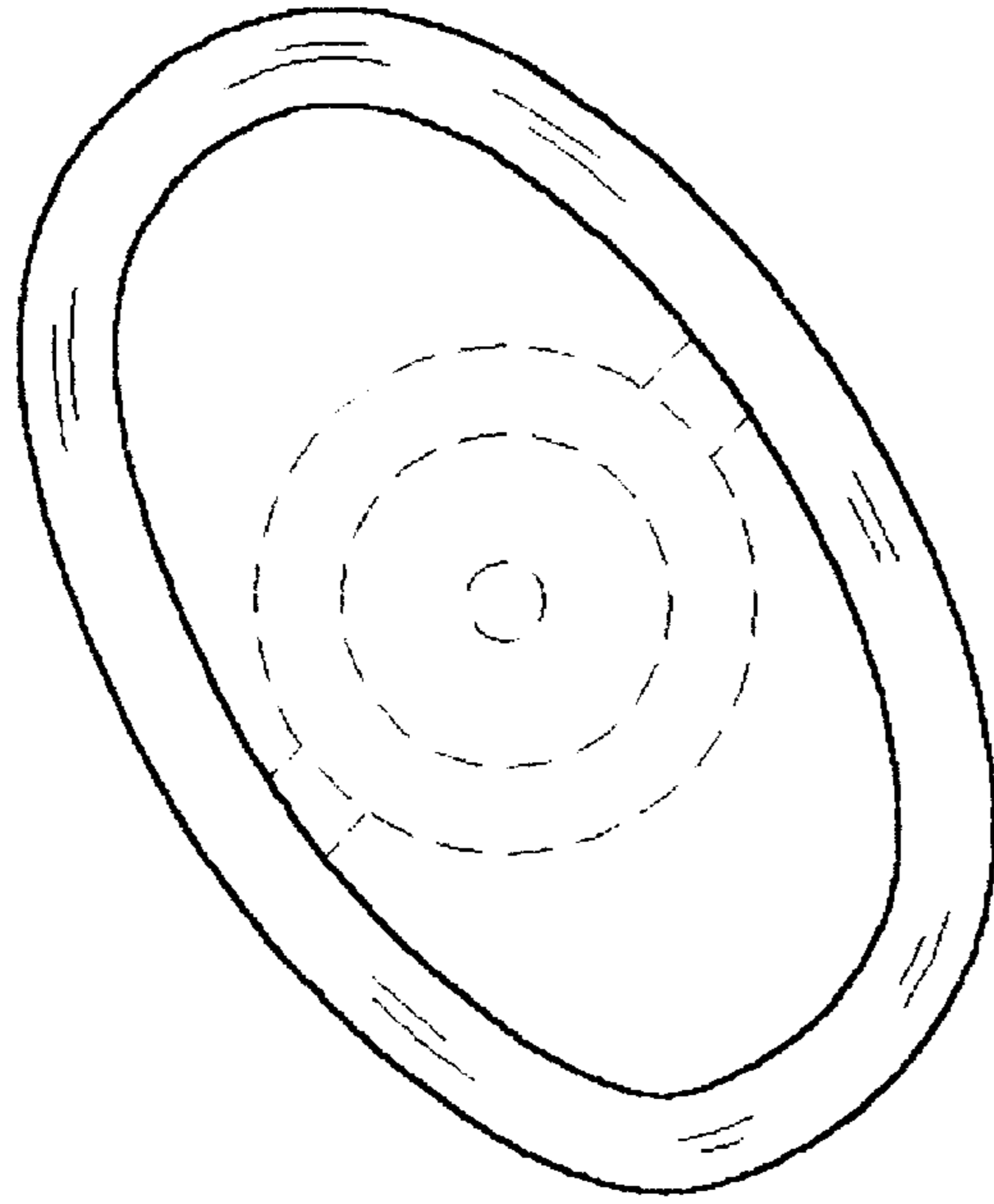

FIG. 7

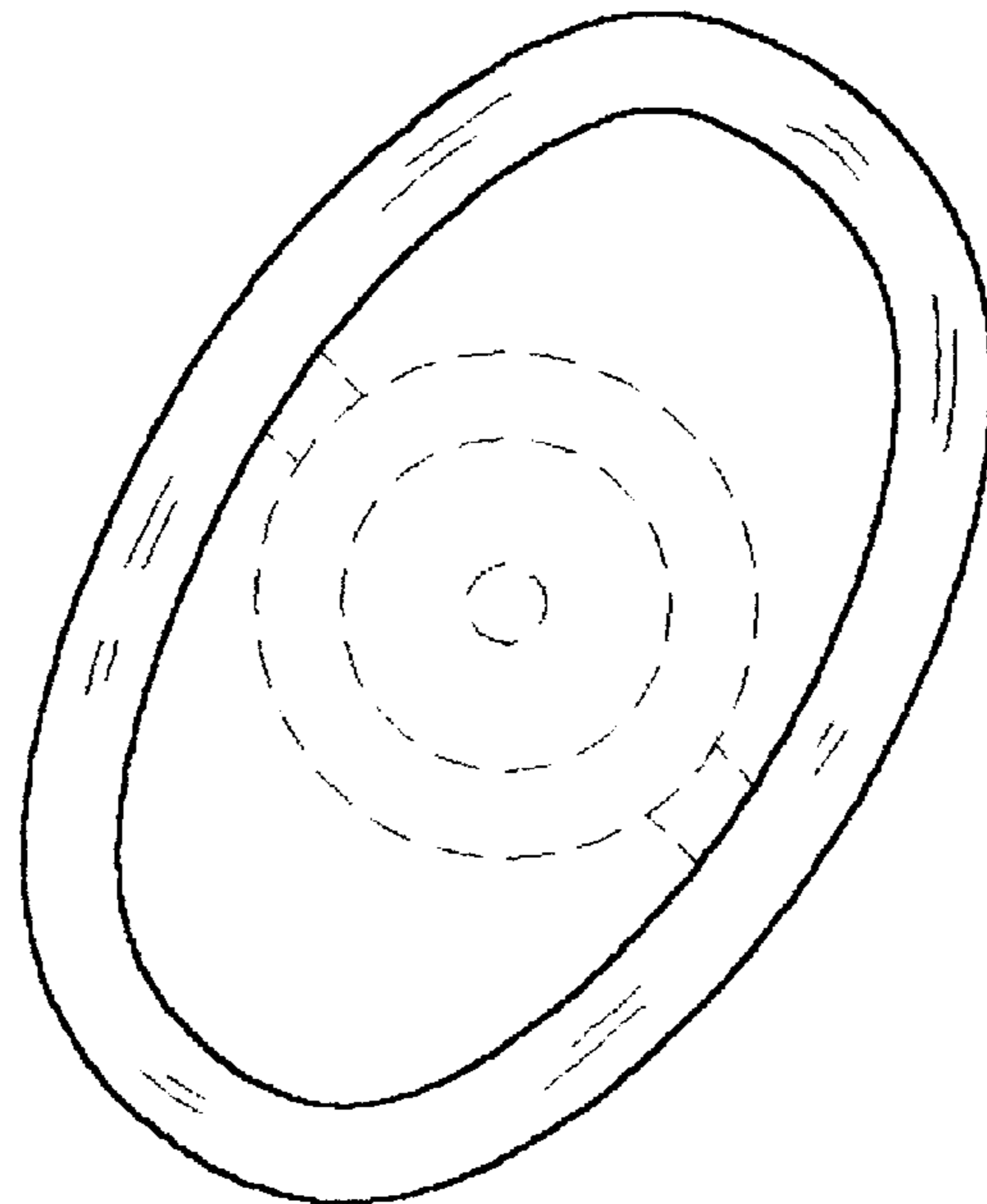

FIG. 6

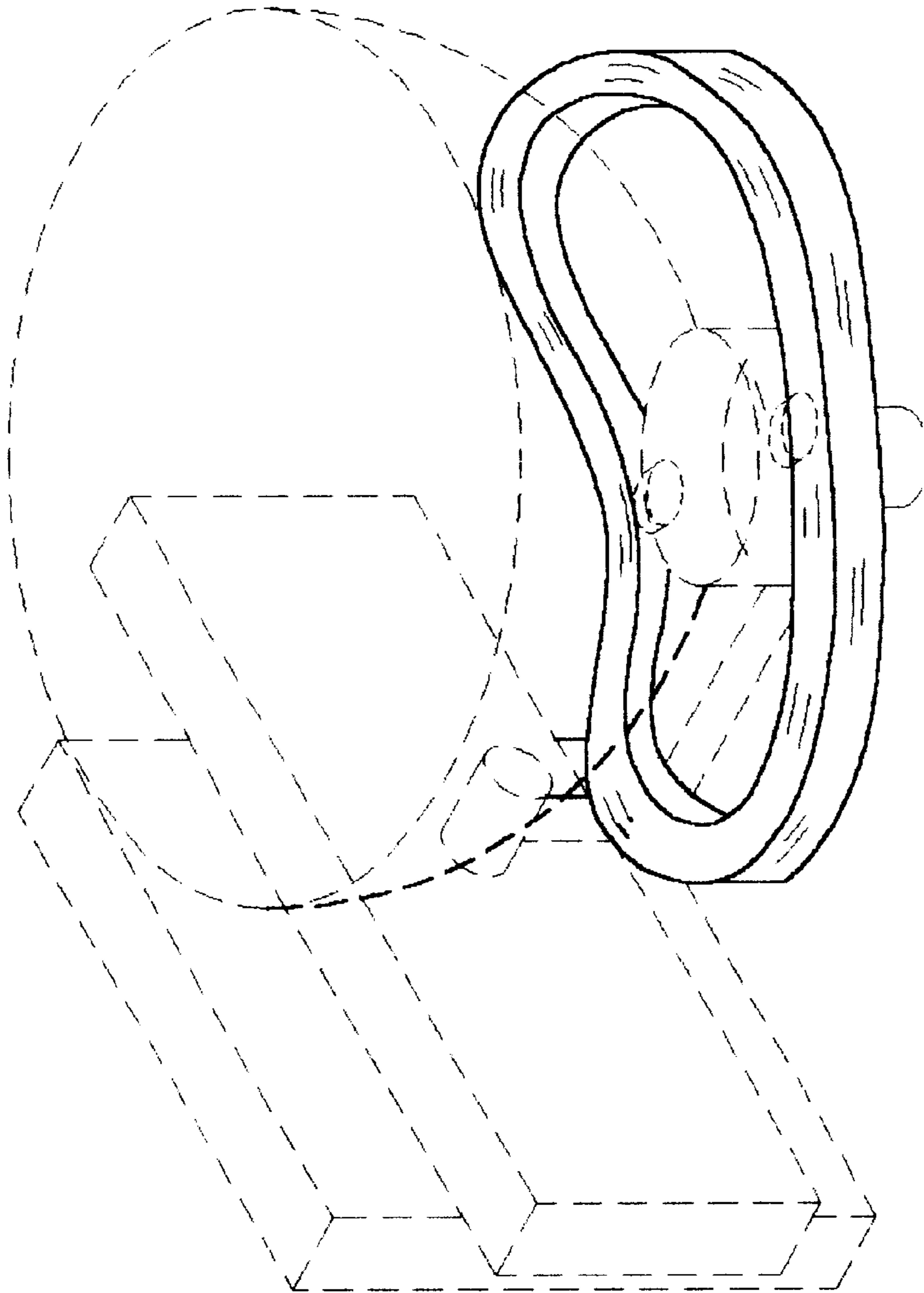

FIG. 8