

US00D522685S

(12) **United States Design Patent** (10) **Patent No.:** **US D522,685 S**
Bayer (45) **Date of Patent:** **** Jun. 6, 2006**

- (54) **TRIM FOR LIGHT FIXTURE**
- (75) Inventor: **Georg Bayer**, Plattsburgh, NY (US)
- (73) Assignee: **Schonbek Worldwide Lighting Inc.**, Pittsburgh, NY (US)
- (**) Term: **14 Years**
- (21) Appl. No.: **29/221,311**
- (22) Filed: **Jan. 12, 2005**
- (51) **LOC (8) Cl.** **26-99**
- (52) **U.S. Cl.** **D26/142; D26/154**
- (58) **Field of Classification Search** D26/154, D26/138, 113, 81, 84, 88, 61-65, 72; D11/90; 362/404-406, 457, 806; 63/26-28, 32
See application file for complete search history.

(56) **References Cited**

U.S. PATENT DOCUMENTS

D55,512 S	*	6/1920	Heller	D11/90
D56,949 S	*	1/1921	Tatler	D11/90
1,560,414 A	*	11/1925	De Haan	63/32
3,619,599 A	*	11/1971	Hermanson	362/250
3,943,353 A	*	3/1976	Tada	362/404
5,109,325 A	*	4/1992	Bayer et al.	362/433
5,116,009 A	*	5/1992	Bayer	248/303
5,144,541 A	*	9/1992	Schonbek	362/405
5,222,805 A	*	6/1993	Schonbek et al.	362/405
5,241,460 A	*	8/1993	Schonbek	362/405
5,285,364 A	*	2/1994	Bayer	362/405
5,567,046 A	*	10/1996	Lucas	362/405
5,906,430 A	*	5/1999	Bayer	362/404
5,921,668 A	*	7/1999	Bayer	362/404
6,921,186 B1	*	7/2005	Viskovich	362/404
2005/0172668 A1	*	8/2005	Bayer et al.	63/28

OTHER PUBLICATIONS

Basket Sconce with Crystal Accents. Item #92659 from Lamps Plus. Found online at lampsplus.com on Aug. 11, 2005.*
 “Star Dust” by Tokujin Yoshioka from the Swarovski Crystal Palace Collection. Posted at mocoloco.com on May 9, 2005.*

James R. Modor, Strass Crystal Mini Pendant Chandelier. Item #55672 from Lamps Plus. Found online at lampsplus.com on Aug. 11, 2005.*
 James R. Modor, Sapphire Mini Pendant Chandelier. Item #55666 from Lamps Plus. Found online at lampsplus.com on Aug. 11, 2005.*
 WAC Catalog (c) 2004, Quick Connect Fixtures, p. 7.
 WAC Catalog (c) 2004, Quick Connect Fixtures, p. 6.
 WAC Catalog (c) 2004, Low Voltage Pendants.
<http://www.lbllighting.com>, Merlino, one page.
<http://www.lbllighting.com>, Merline Swivel II, one page.

* cited by examiner

Primary Examiner—Clare E Hefflin

(74) *Attorney, Agent, or Firm*—Heslin Rothenberg Farley & Mesiti, P.C.

(57) **CLAIM**

The ornamental design for a trim for light fixture, as shown and described.

DESCRIPTION

FIG. 1 is an isometric view of a first embodiment of the trim for light fixture of the present invention;
 FIG. 2 is a front elevation view thereof;
 FIG. 3 is a top plan view thereof;
 FIG. 4 is a bottom plan view thereof;
 FIG. 5 is a right side elevation view thereof;
 FIG. 6 is a left side elevation view thereof;
 FIG. 7 is an isometric view of the first embodiment in a different environmental structure;
 FIG. 8 is an isometric view of the first embodiment in another environmental structure;
 FIG. 9 is an isometric view of a second embodiment;
 FIG. 10 is an elevation view of the first embodiment in a different environmental structure;
 FIG. 11 is an elevation view of the first embodiment in another environmental structure; and,
 FIG. 12 is an isometric view of the first embodiment in yet another environmental structure.
 The broken line showing is for illustrative purposes only and forms no part of the claimed invention.

1 Claim, 12 Drawing Sheets

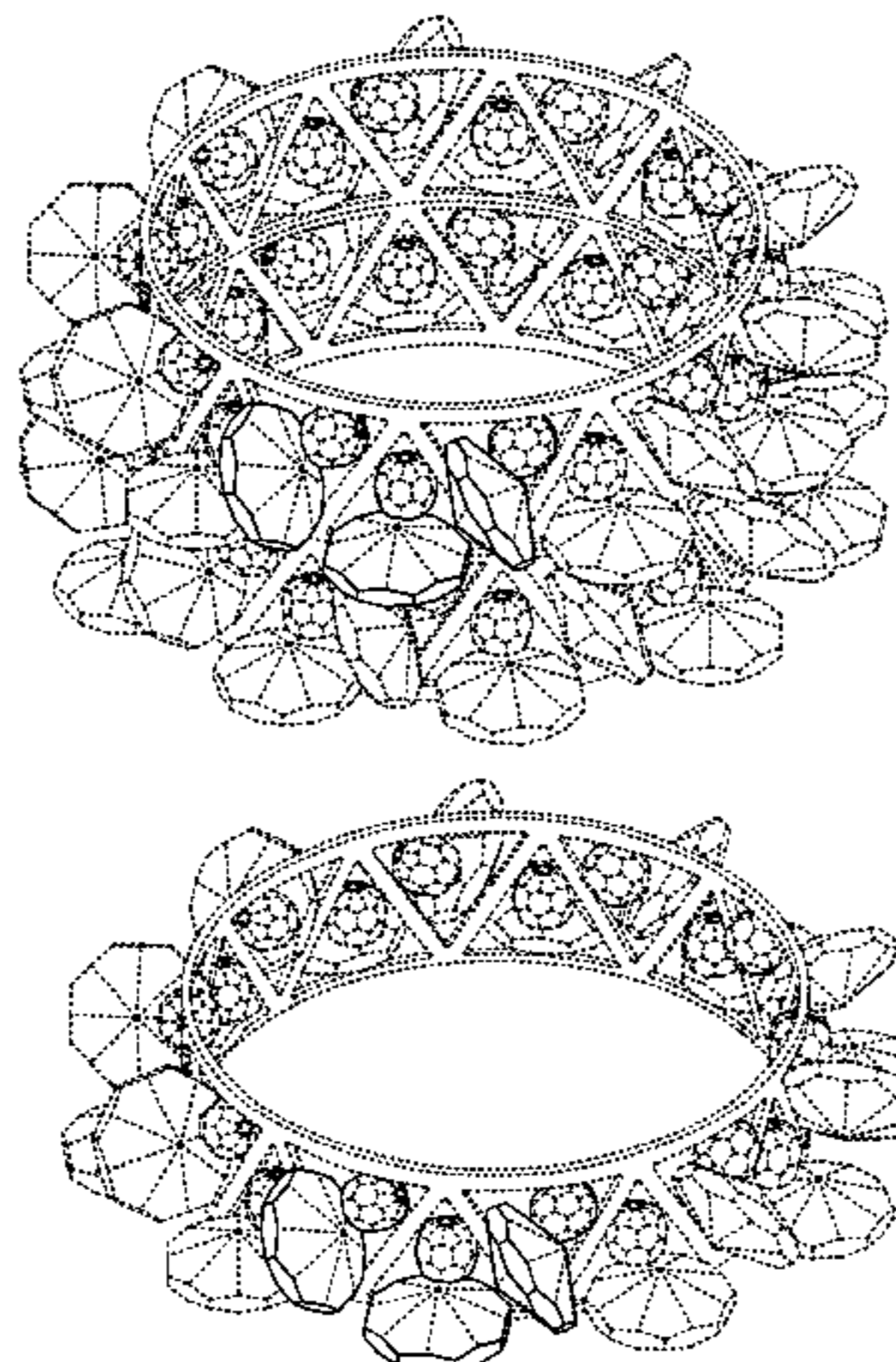

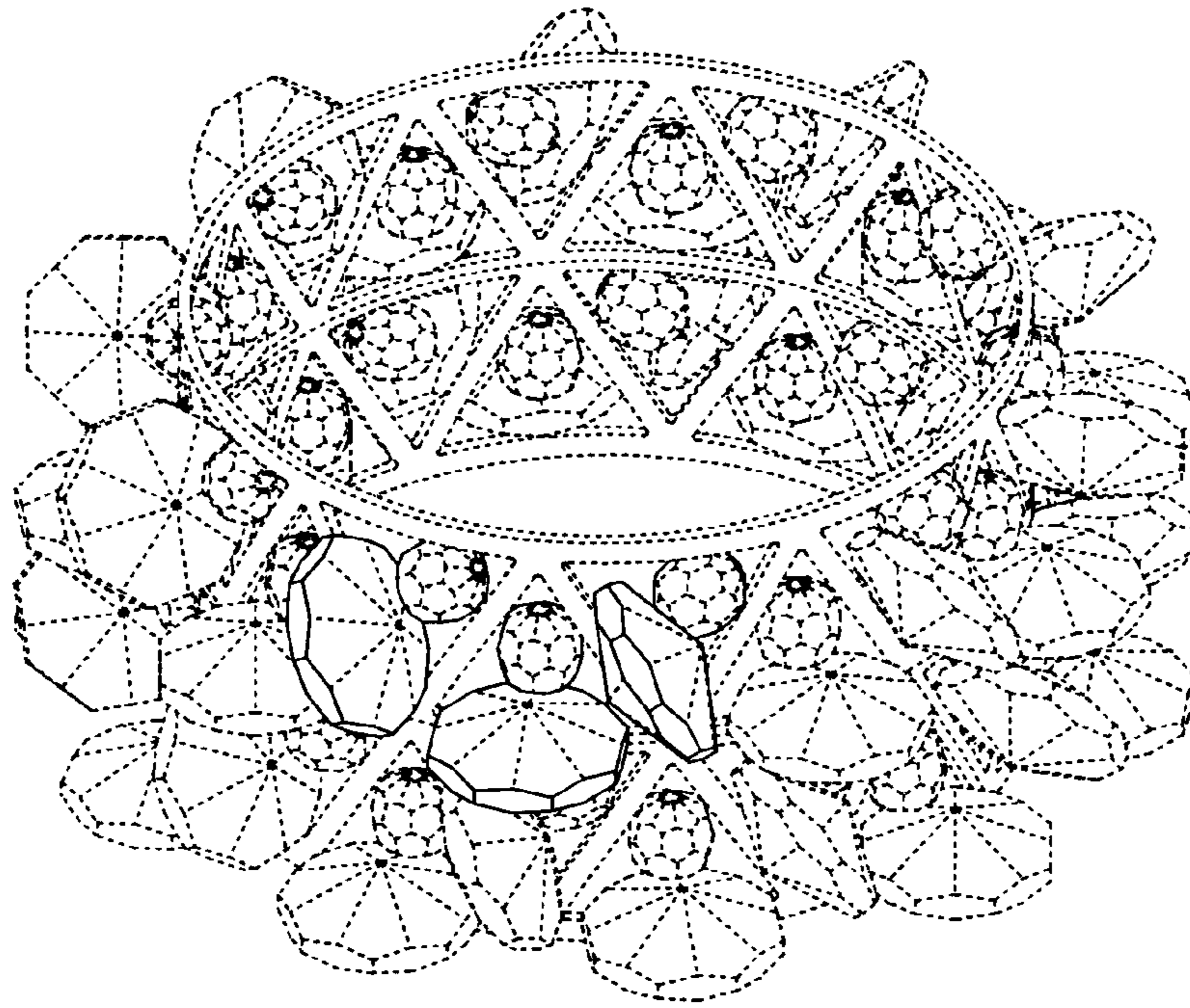

FIG. 1

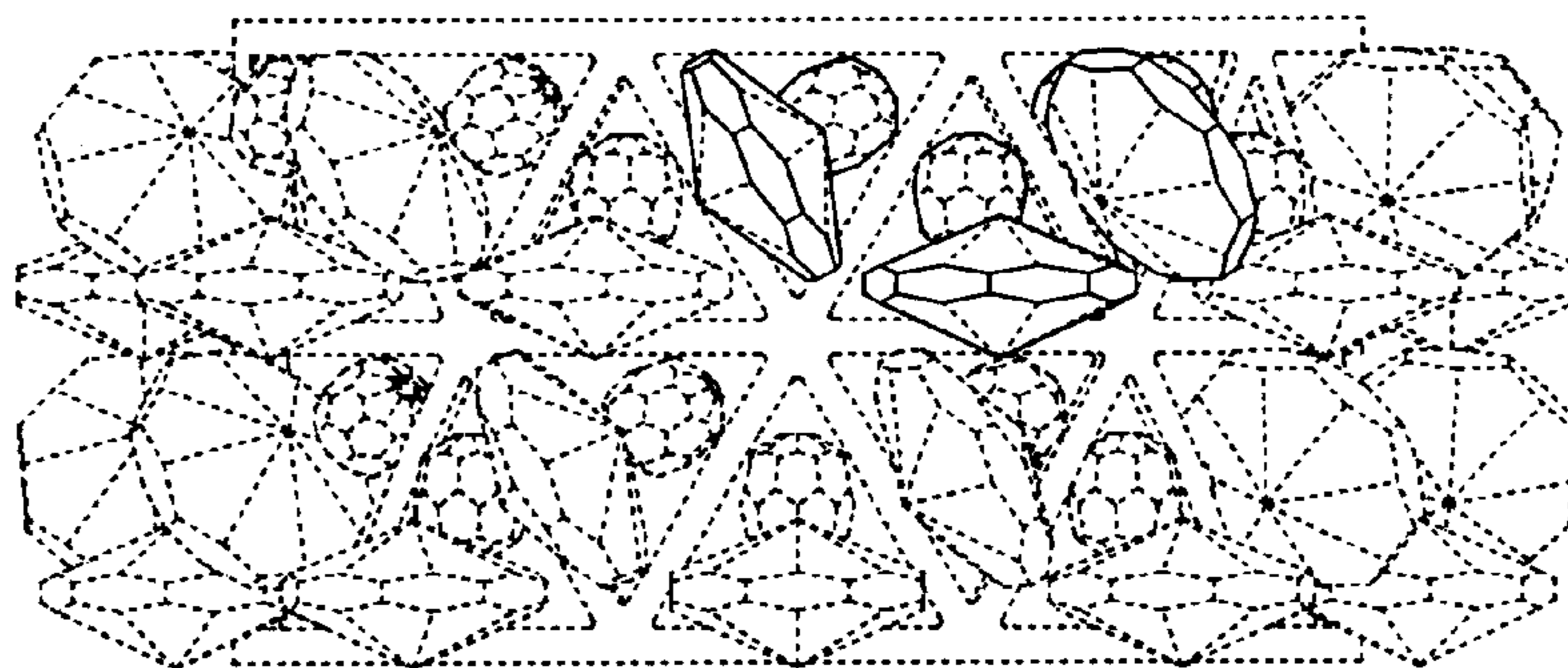

FIG. 2

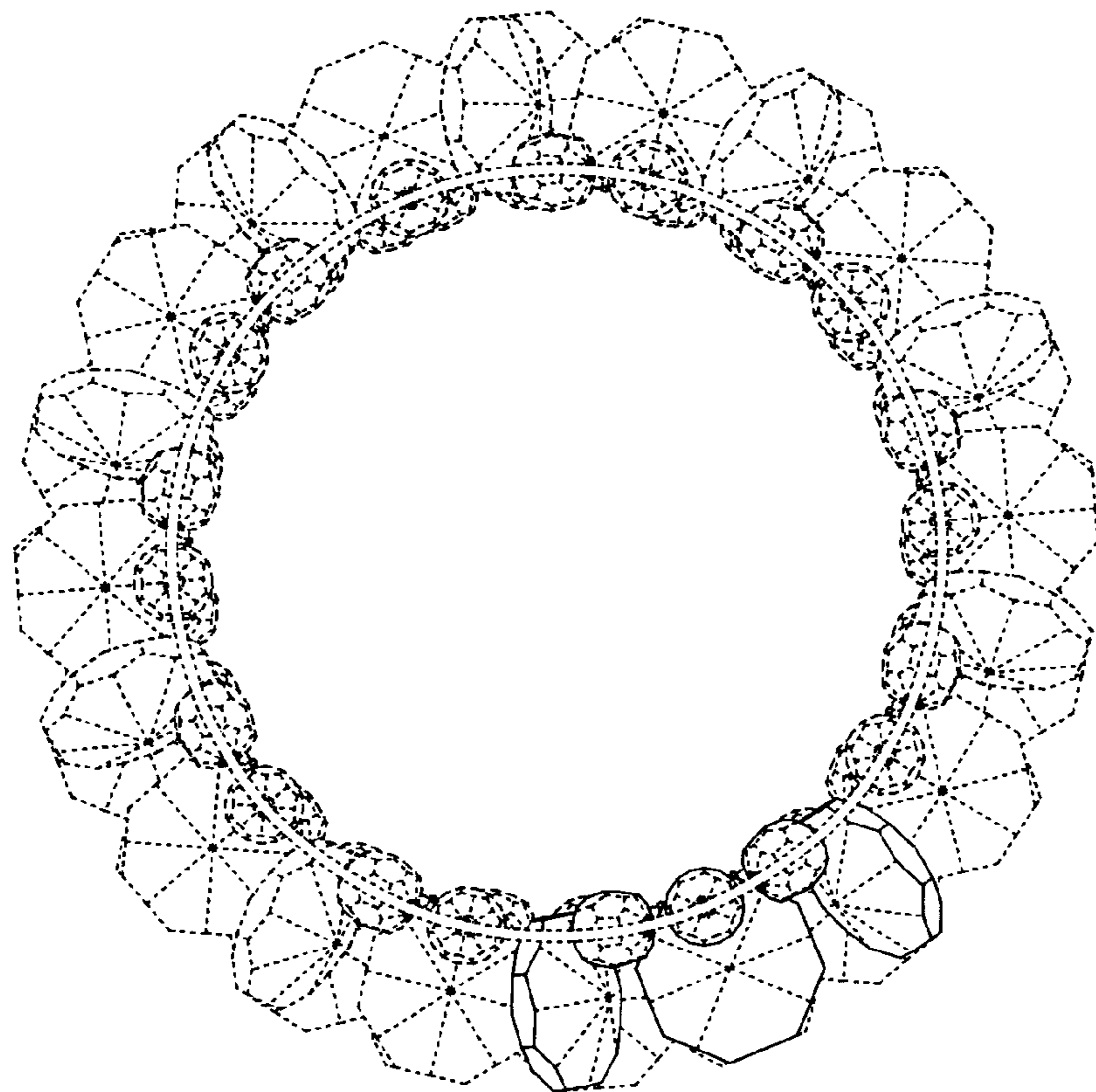

FIG. 3

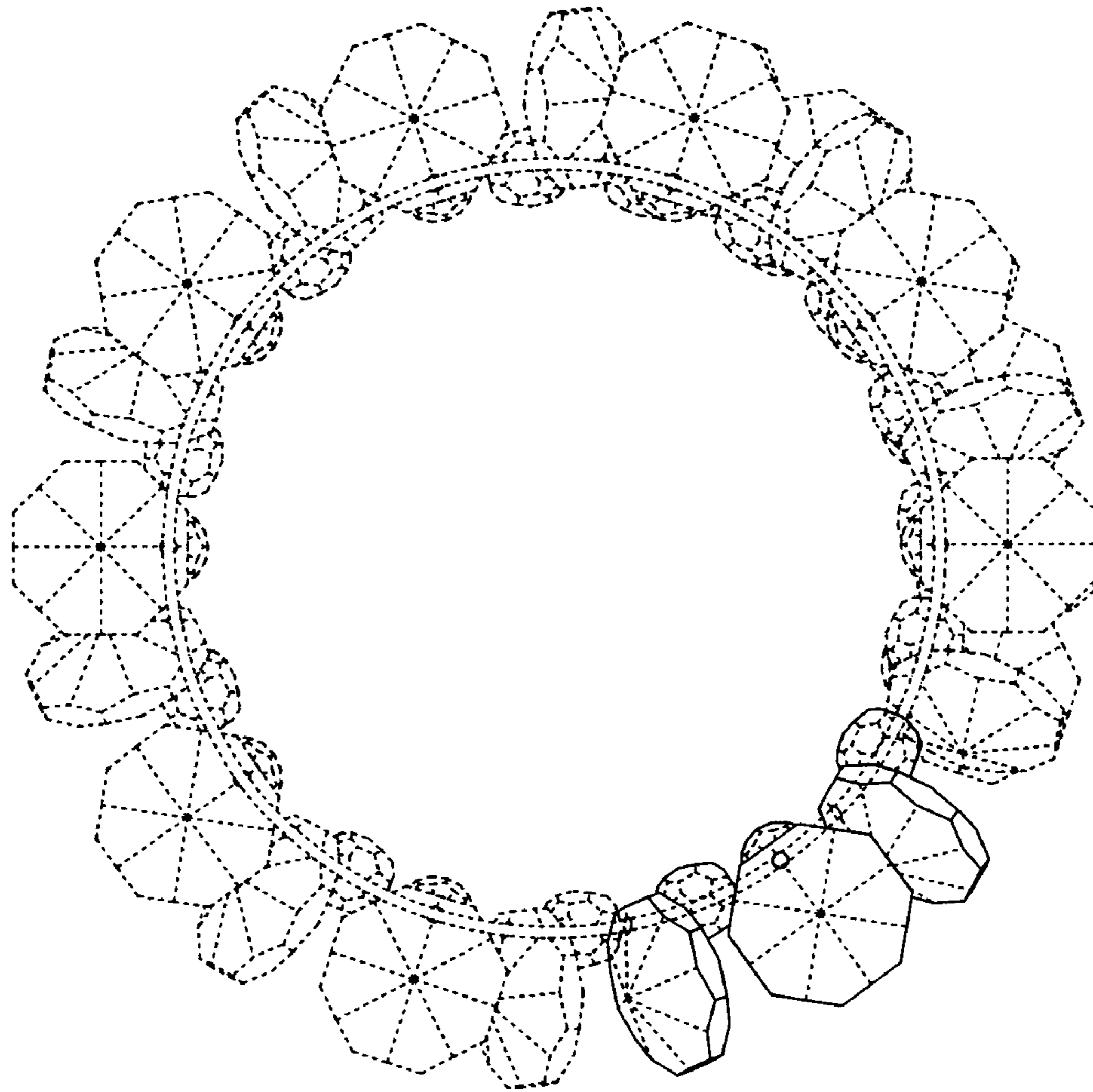

FIG. 4

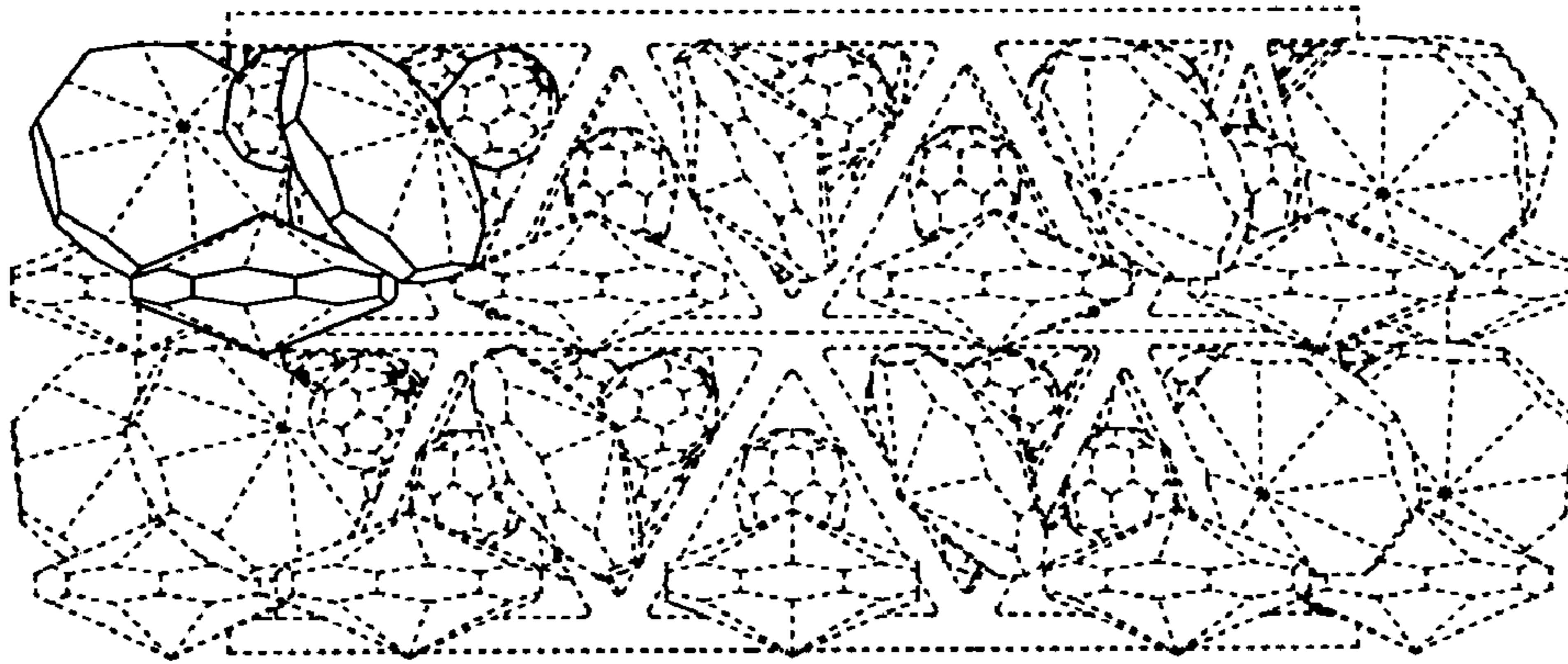

FIG. 5

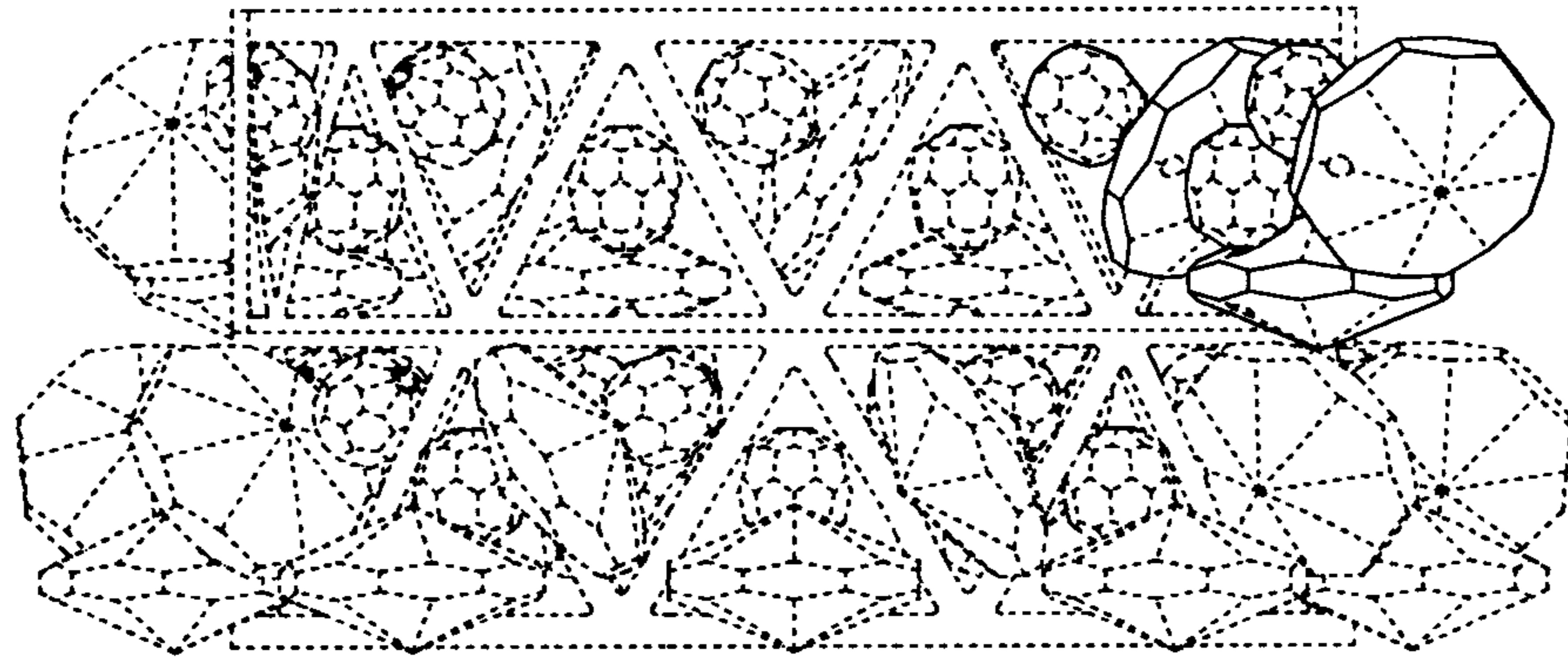

FIG. 6

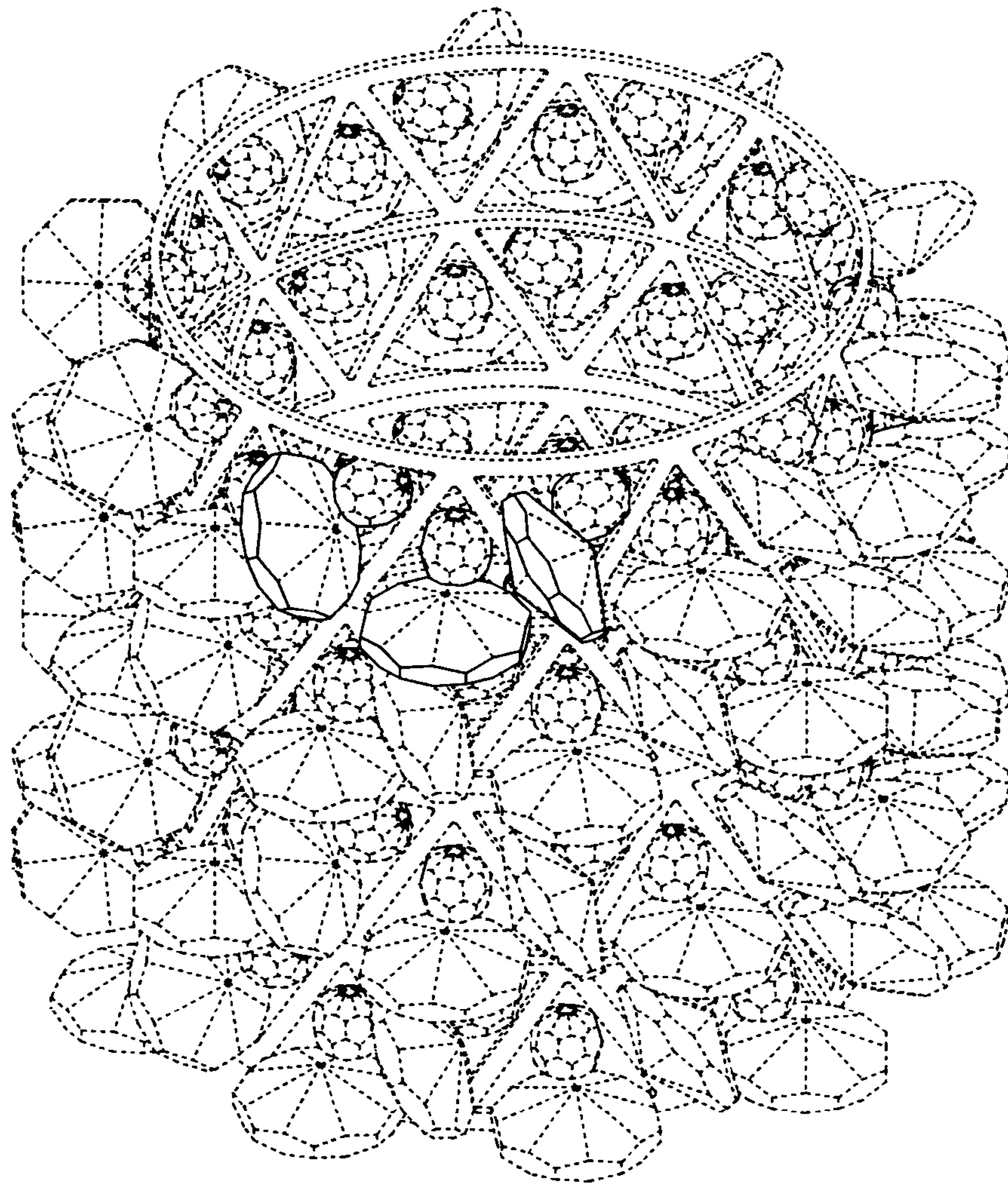

FIG. 7

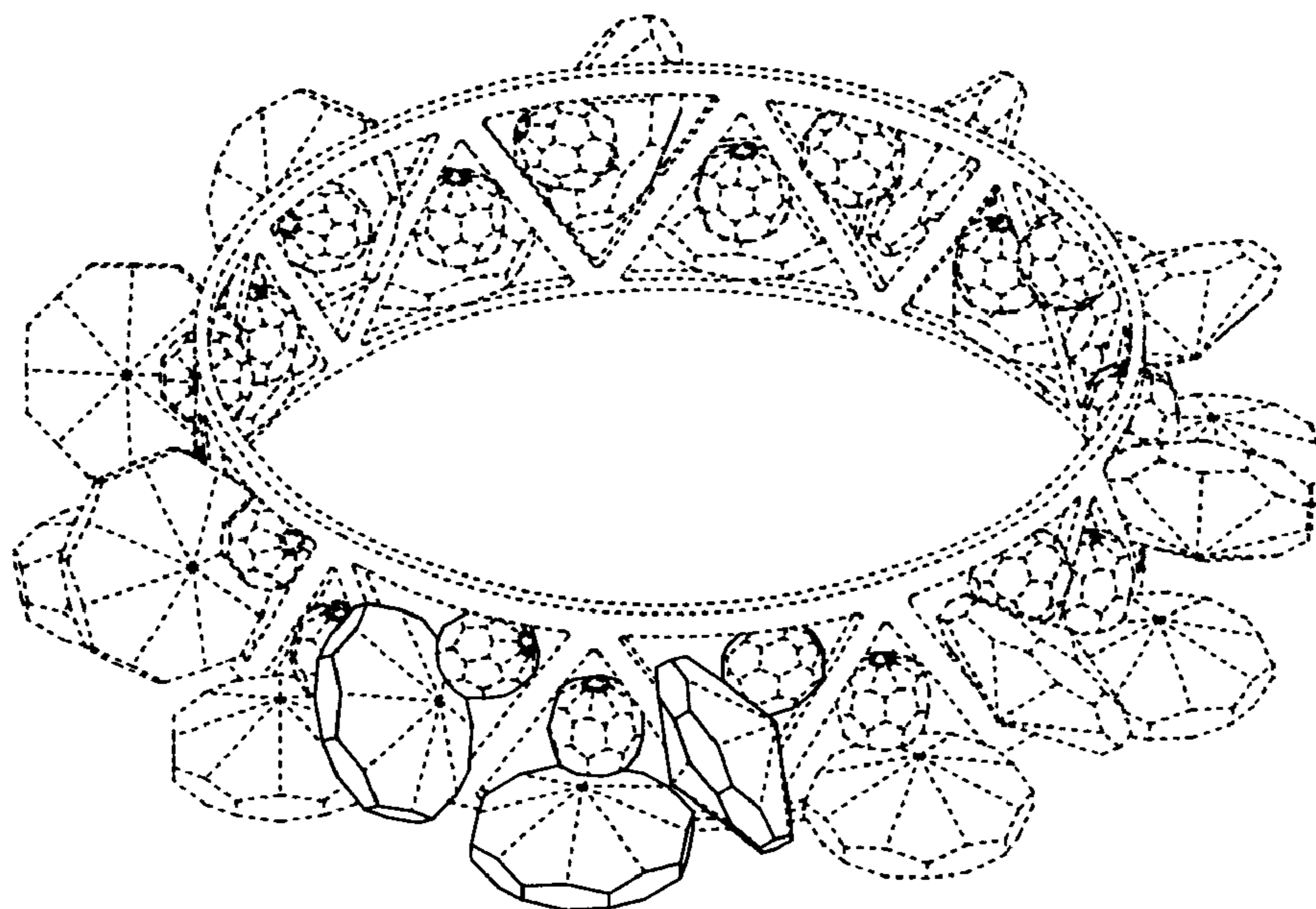

FIG. 8

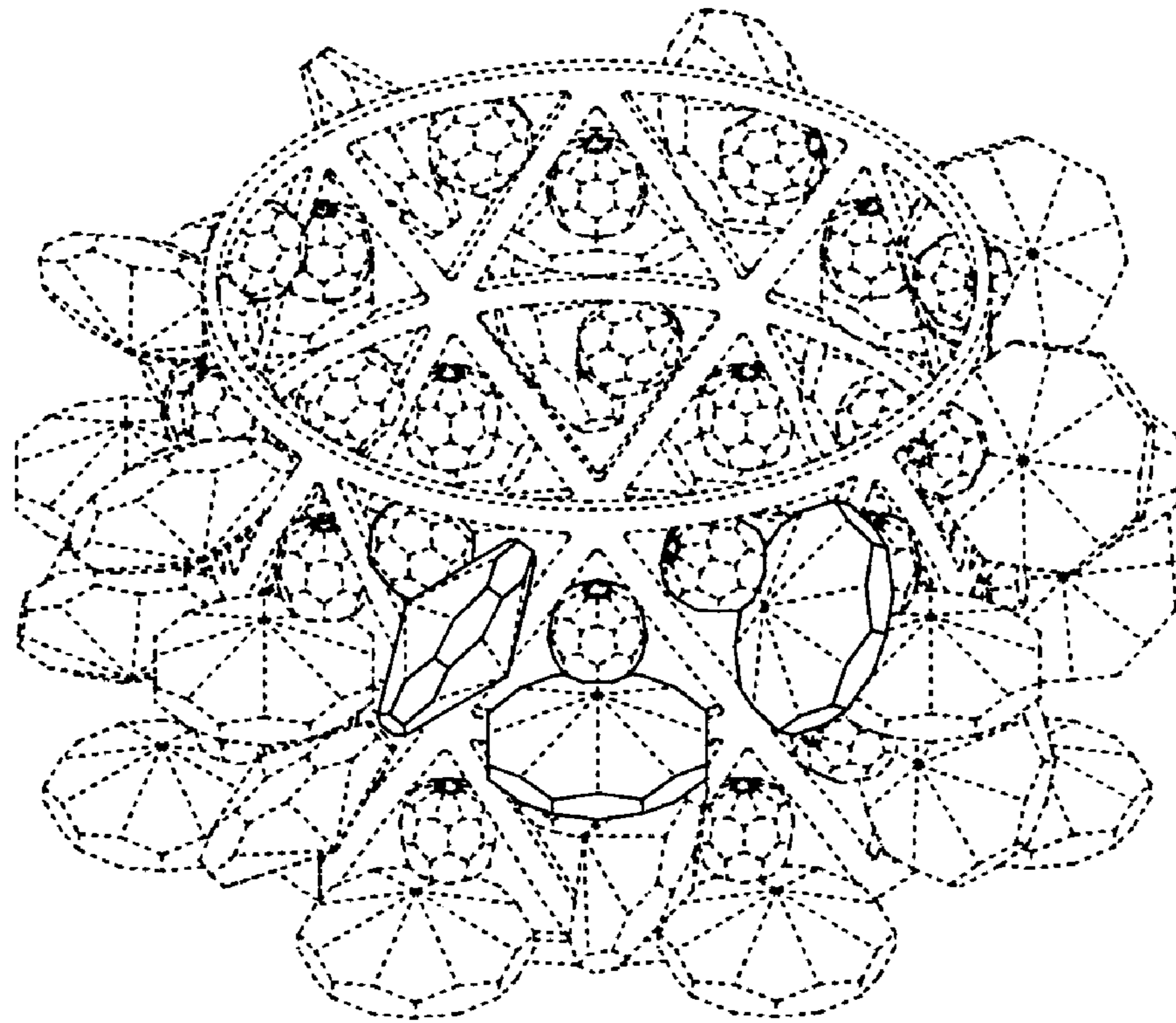

FIG. 9

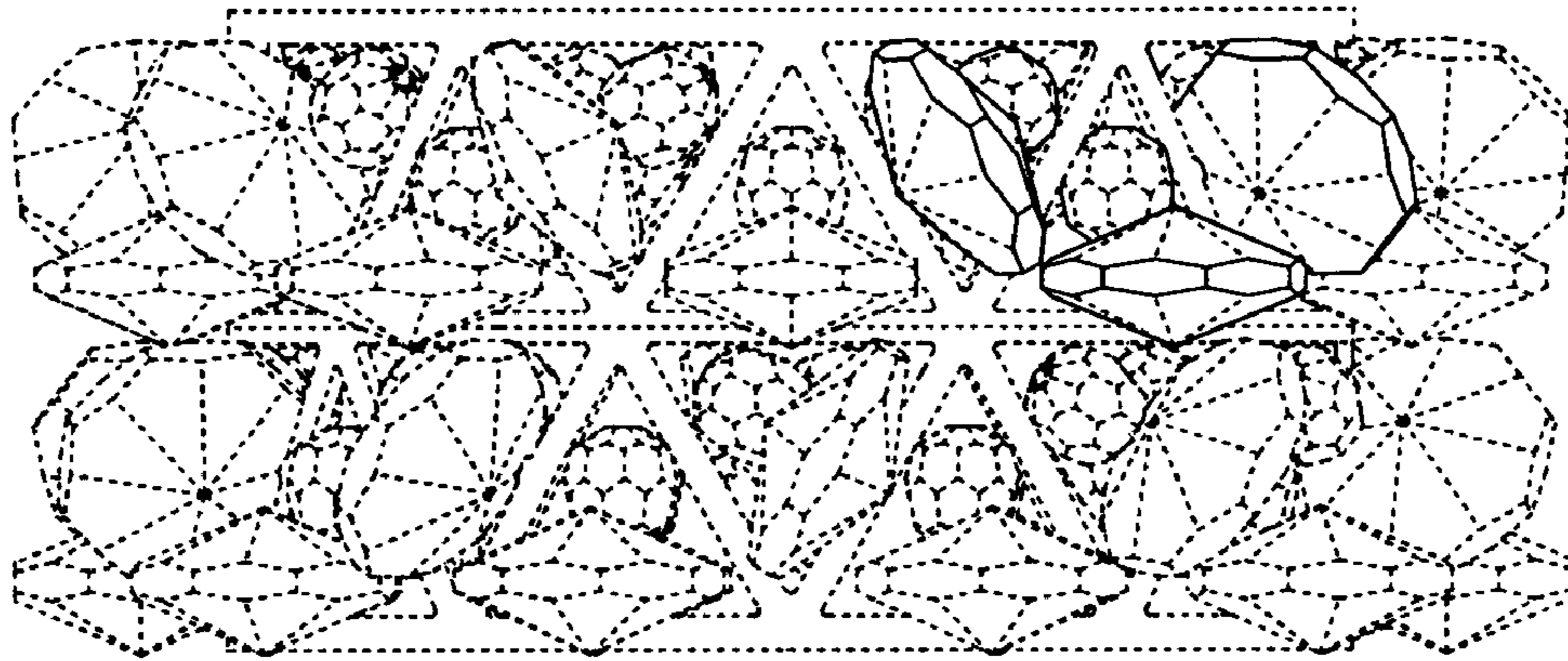

FIG. 10

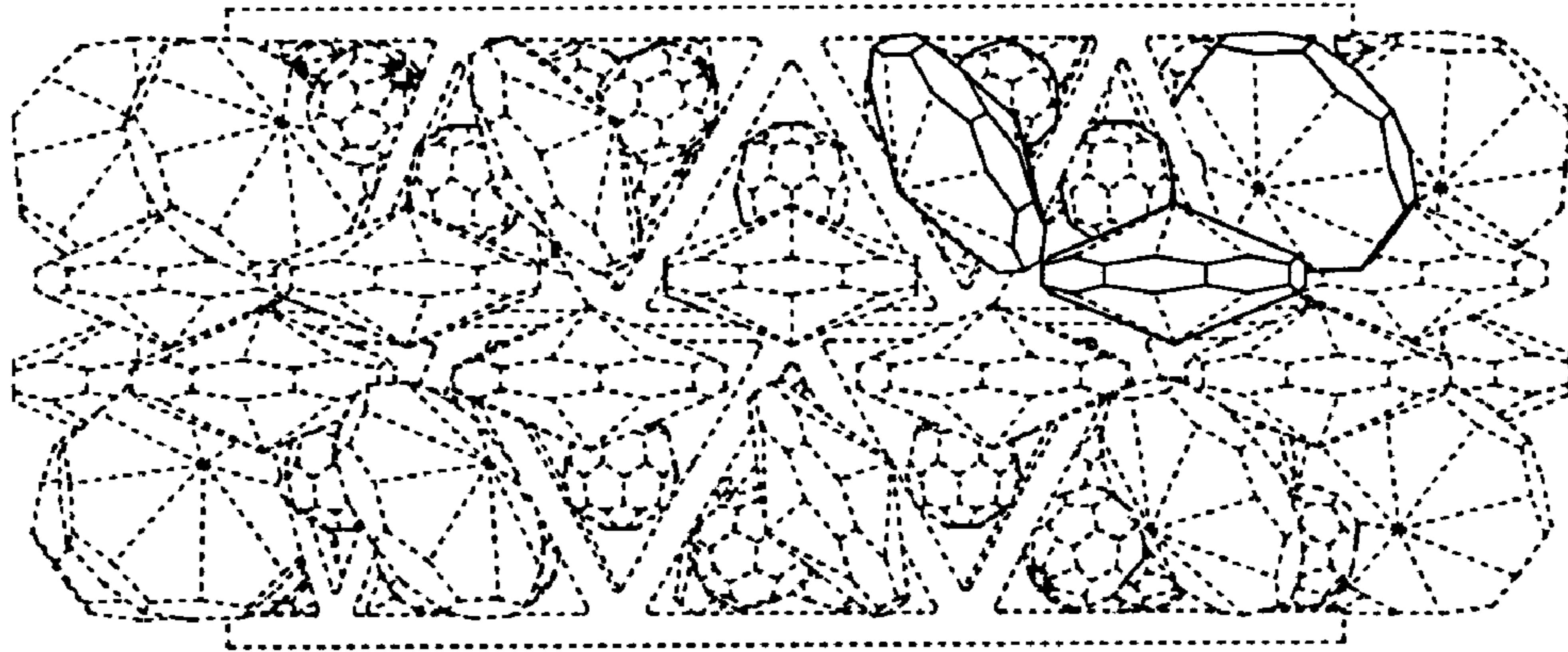

FIG. 11

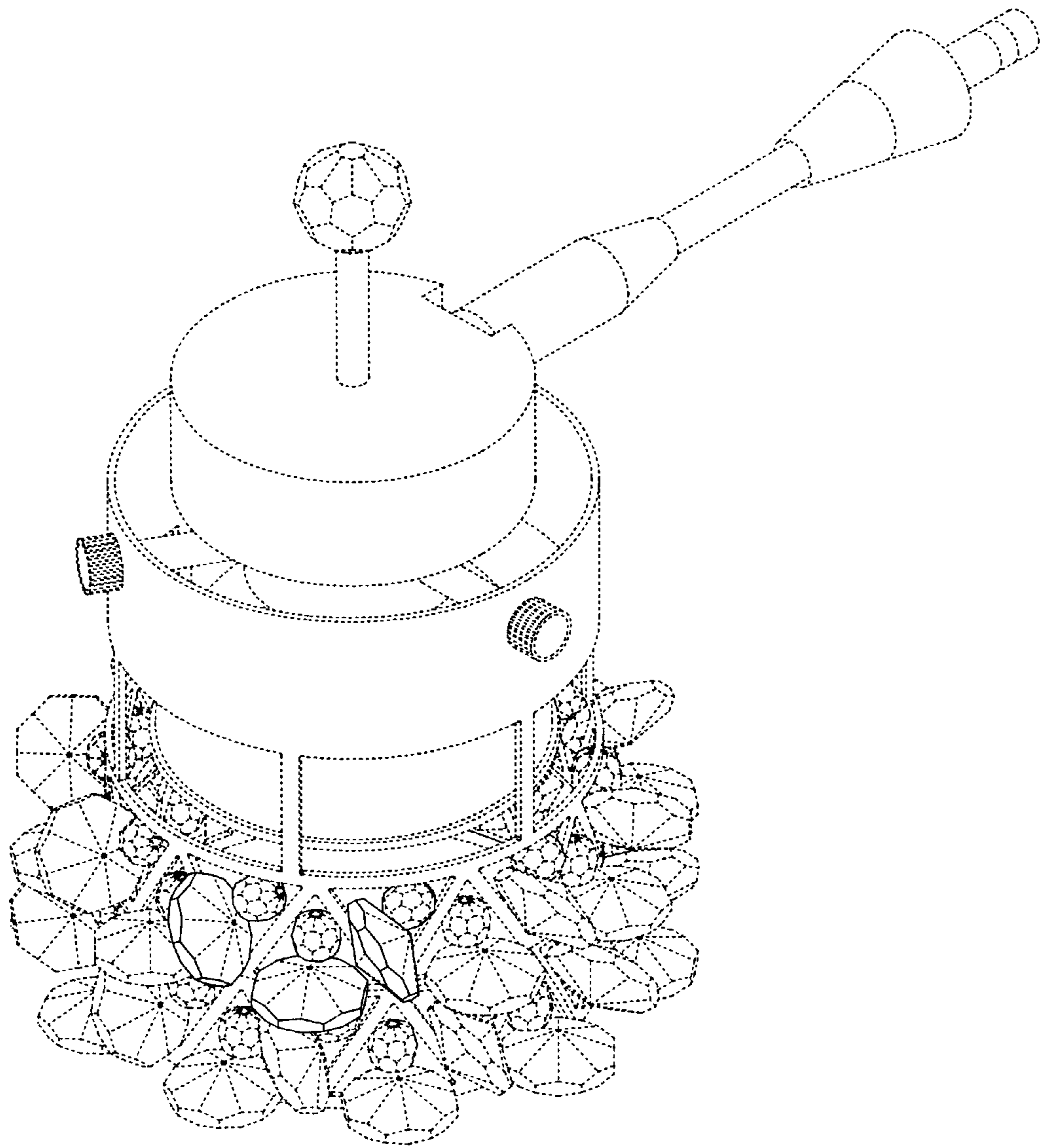

FIG. 12

UNITED STATES PATENT AND TRADEMARK OFFICE
CERTIFICATE OF CORRECTION

PATENT NO. : Des. 522,685 S
APPLICATION NO. : 29/221311
DATED : June 6, 2006
INVENTOR(S) : Bayer

Page 1 of 1

It is certified that error appears in the above-identified patent and that said Letters Patent is hereby corrected as shown below:

Title Page:

Item (73) Assignee:

Delete "Schonbek Worldwide Lighting, Inc. Pittsburgh, NY (US)" and insert
--Schonbek Worldwide Lighting, Inc. Plattsburgh, NY (US)--

Signed and Sealed this

Twenty-second Day of August, 2006

A handwritten signature in black ink on a light gray dotted background. The signature reads "Jon W. Dudas" in a cursive style.

JON W. DUDAS

Director of the United States Patent and Trademark Office