



US00D522505S

(12) **United States Design Patent**  
**Sun et al.**

(10) **Patent No.:** **US D522,505 S**  
(45) **Date of Patent:** **\*\* Jun. 6, 2006**

(54) **INFORMATION HANDLING SYSTEM**

(75) Inventors: **Cecilia H. Sun**, Austin, TX (US);  
**Darren Blum**, San Mateo, CA (US);  
**Robert Brunner**, San Francisco, CA  
(US); **Kenneth Musgrave**, Austin, TX  
(US); **Huy Nguyen**, Round Rock, TX  
(US); **Symon Whitehorn**, Sausalito, CA  
(US)

(73) Assignee: **Dell Products L.P.**, Round Rock, TX  
(US)

(\*\*) Term: **14 Years**

(21) Appl. No.: **29/235,940**

(22) Filed: **Aug. 8, 2005**

(51) **LOC (8) Cl.** ..... **14-02**

(52) **U.S. Cl.** ..... **D14/349**

(58) **Field of Classification Search** ..... D14/349-356;  
D13/162, 184, 199; D6/432, 436, 445, 448;  
312/223.1-223.3; 360/99.01-99.12; 361/680-686,  
361/690-696; 369/34.01, 36.01  
See application file for complete search history.

(56) **References Cited**

**U.S. PATENT DOCUMENTS**

D322,778 S \* 12/1991 Kline et al. .... D14/354

D428,005 S \* 7/2000 Takizawa et al. .... D14/349  
D452,239 S \* 12/2001 Kitayama et al. .... D14/349  
D468,737 S \* 1/2003 Chien et al. .... D14/349  
D478,078 S \* 8/2003 Miao et al. .... D14/349  
D487,743 S \* 3/2004 Kim ..... D14/349

\* cited by examiner

*Primary Examiner*—Freda S. Nunn

(74) *Attorney, Agent, or Firm*—Hamilton & Terrile, LLP;  
Stephen A. Terrile

(57) **CLAIM**

The ornamental design for an information handling system,  
as shown and described.

**DESCRIPTION**

FIG. 1 is a front left angled perspective view of the infor-  
mation handling system comprising the present invention  
the broken lines being shown for illustrative purposes only  
and form no part of the claimed design;  
FIG. 2 is a front elevation view thereof;  
FIG. 3 is a right side elevation view thereof;  
FIG. 4 is a left side elevation view thereof;  
FIG. 5 is a back plan view thereof;  
FIG. 6 is a top plan view thereof; and,  
FIG. 7 is a bottom view thereof.

**1 Claim, 4 Drawing Sheets**

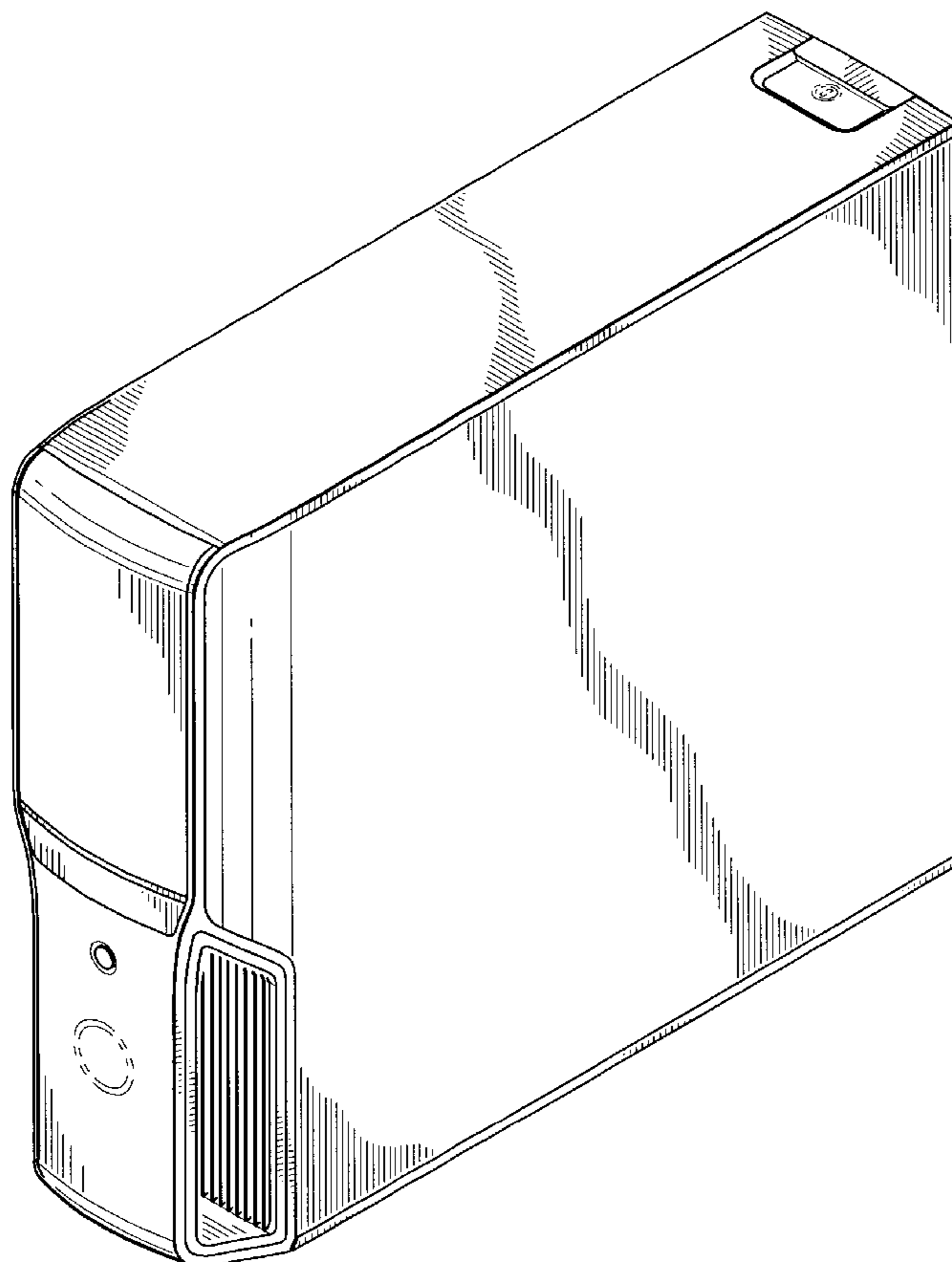

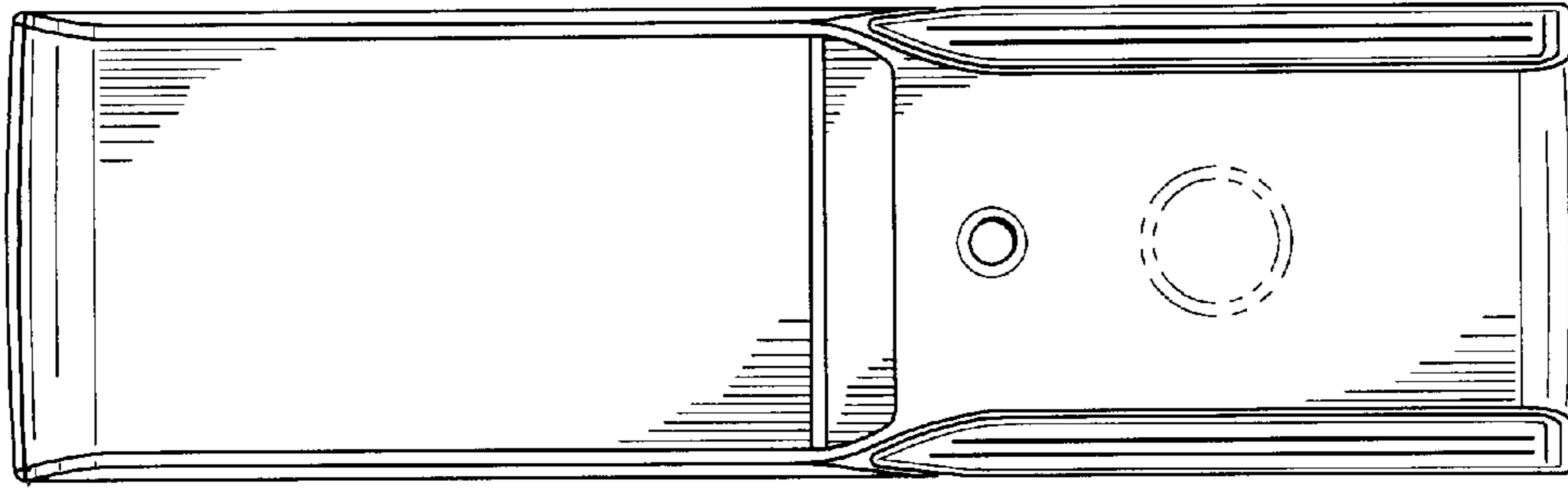

FIG. 2

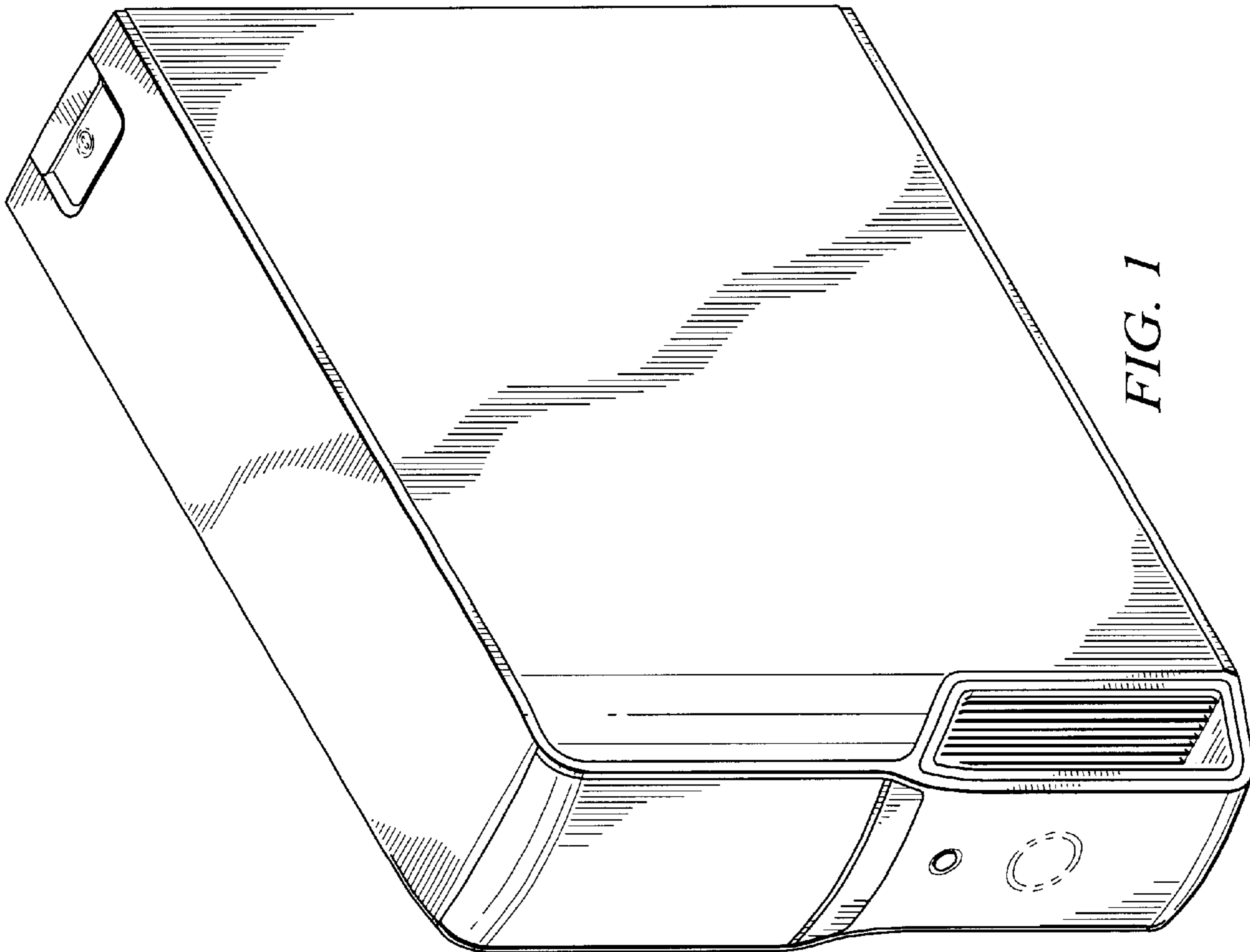
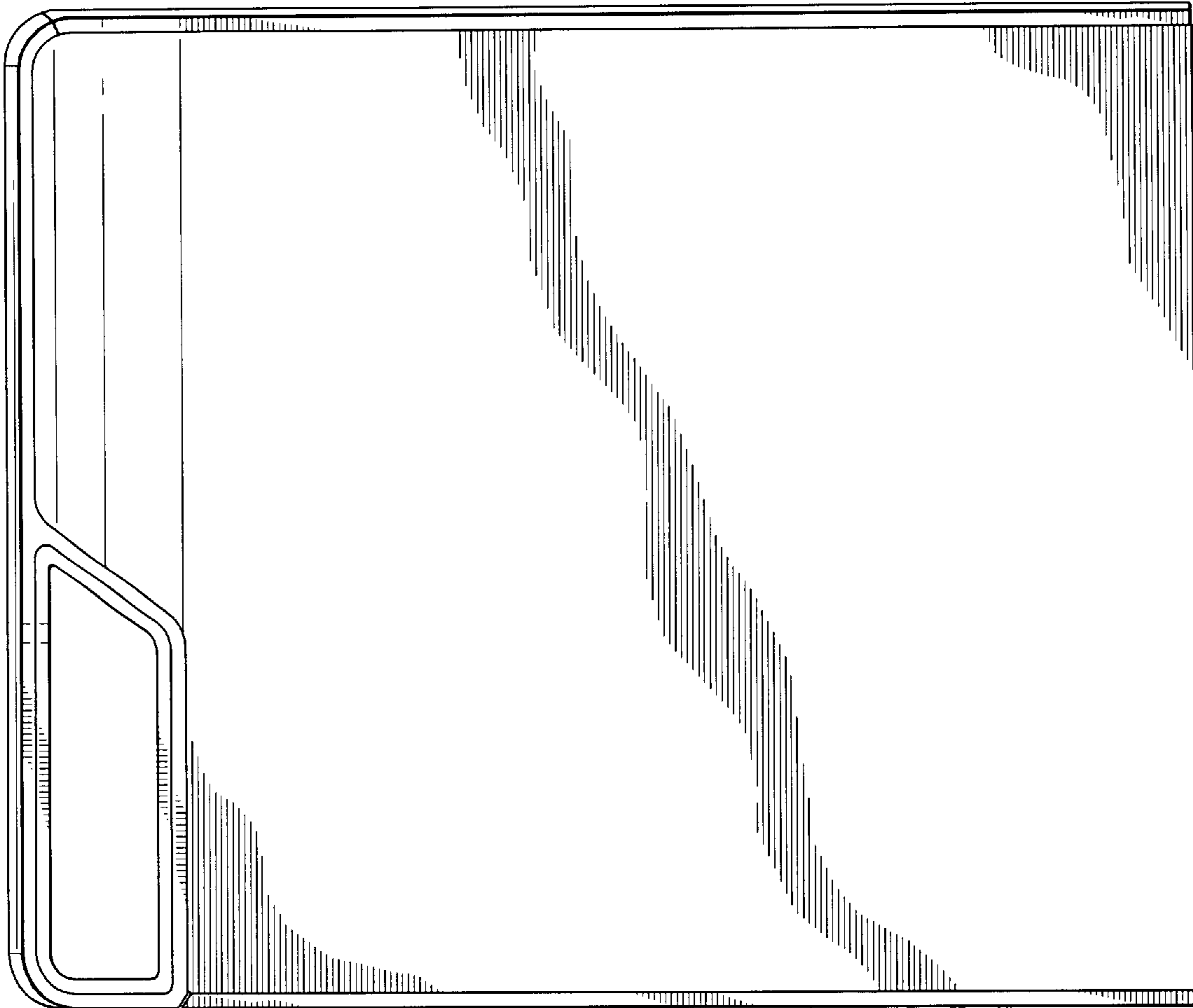

FIG. 1



*FIG. 3*

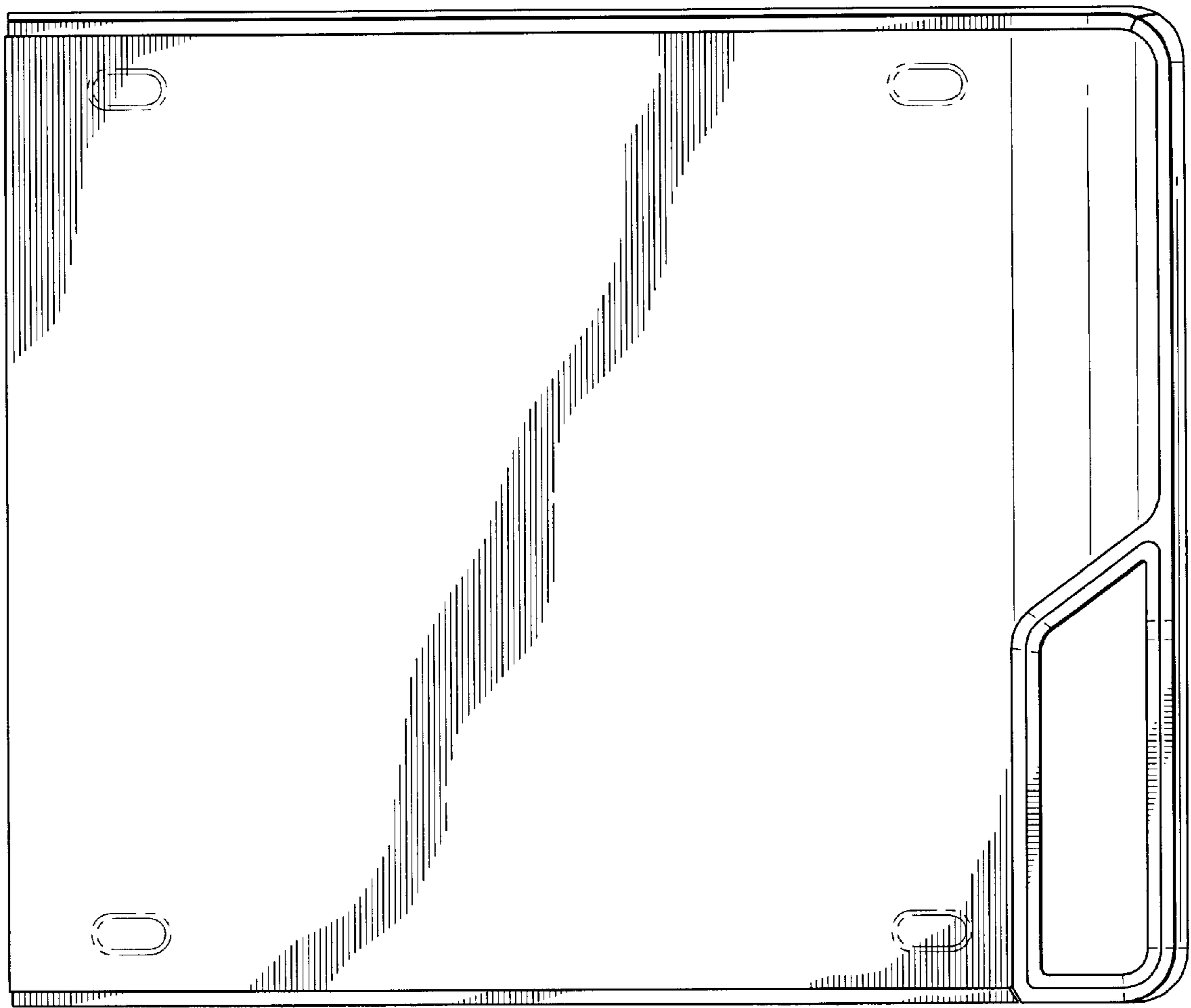

FIG. 4

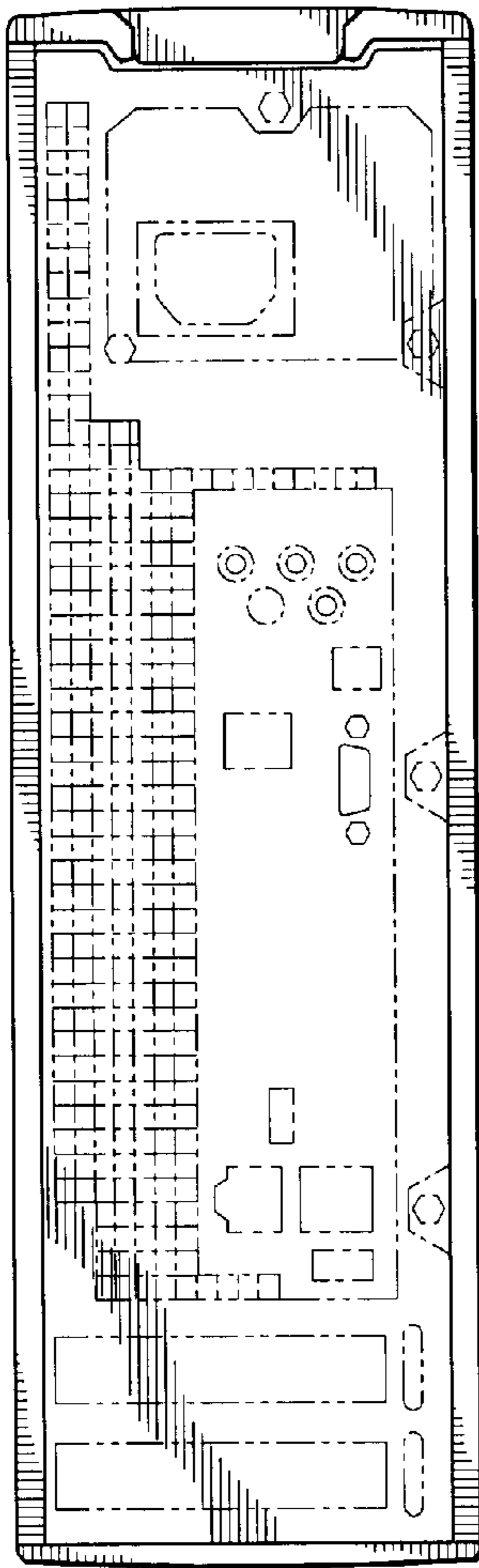

FIG. 5

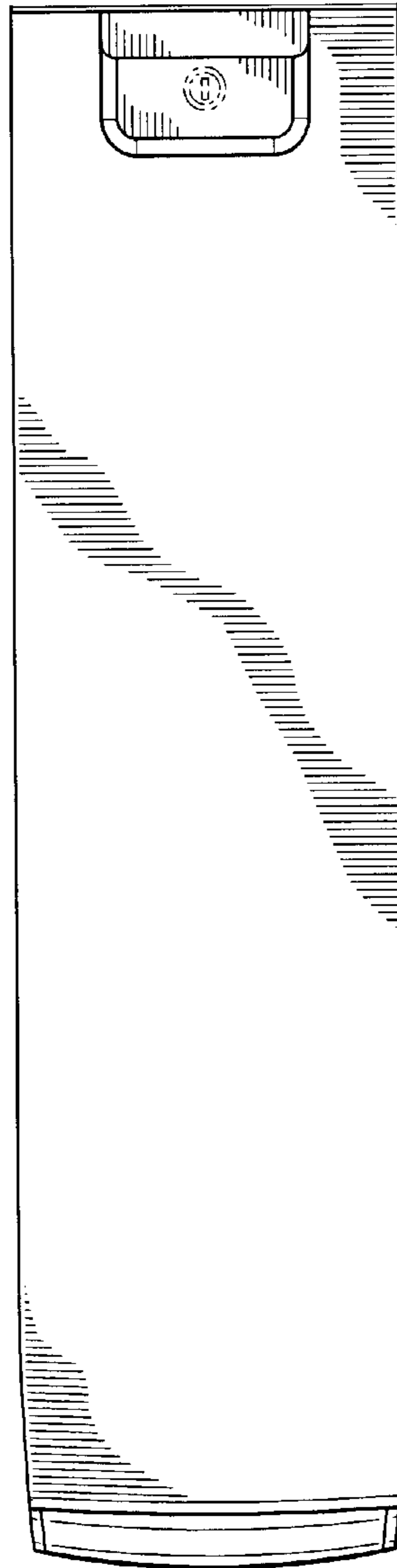

FIG. 6

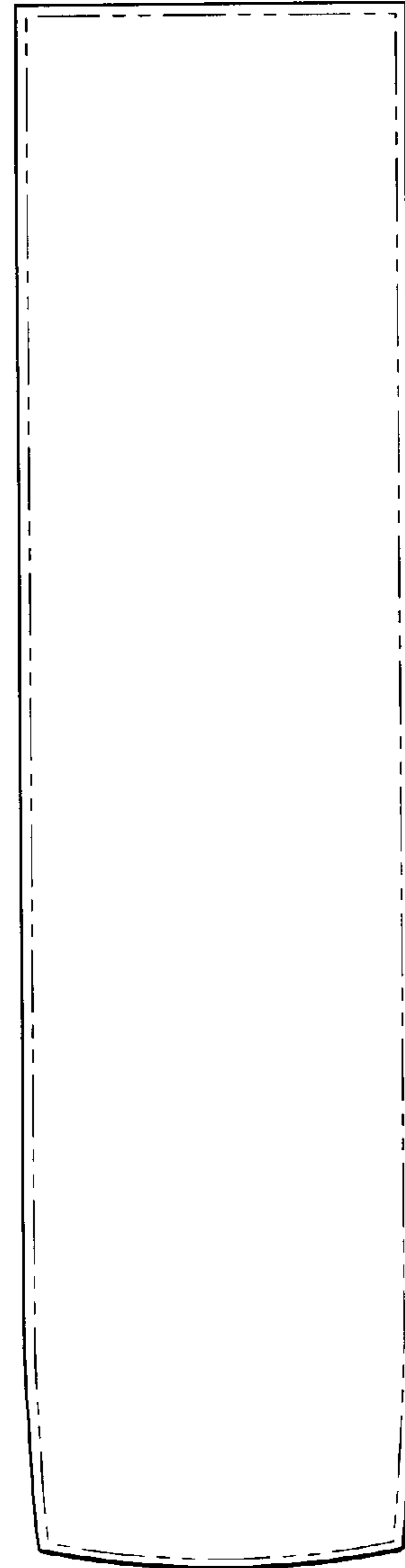

FIG. 7