



US00D522490S

(12) **United States Design Patent**
Yukikado et al.

(10) **Patent No.:** **US D522,490 S**
(45) **Date of Patent:** **** Jun. 6, 2006**

(54) **OUTDOOR INTERCOM UNIT**

(75) Inventors: **Kouji Yukikado**, Ehime (JP); **Tamotsu Senda**, Ehime (JP)

(73) Assignee: **Matsushita Electric Industrial, Co., Ltd.**, Osaka (JP)

(**) Term: **14 Years**

(21) Appl. No.: **29/218,529**

(22) Filed: **Dec. 3, 2004**

(30) **Foreign Application Priority Data**

Jul. 28, 2004 (JP) 2004-022574

(51) **LOC (8) Cl.** **14-03**

(52) **U.S. Cl.** **D14/159**

(58) **Field of Classification Search** D14/159,
D14/158, 142; D13/177; 713/182; 455/575.2;
379/176, 167.14, 167.05; 348/156, 155

See application file for complete search history.

(56) **References Cited**

U.S. PATENT DOCUMENTS

- 4,130,728 A * 12/1978 Grauel 379/167.05
- D283,130 S * 3/1986 Boenning D14/159
- 4,584,436 A * 4/1986 Boenning et al. 379/176
- 4,843,461 A * 6/1989 Tatsumi et al. 348/156
- D321,686 S * 11/1991 Plozner D14/159
- 5,210,520 A * 5/1993 Housley 340/326
- D381,638 S * 7/1997 Kruse et al. D14/342
- 5,657,380 A * 8/1997 Mozer 379/88.01
- D394,653 S * 5/1998 Kato et al. D14/159
- D394,656 S * 5/1998 Kato et al. D14/159
- D399,495 S * 10/1998 Bachschmid D13/177

- D410,004 S * 5/1999 LaPorte et al. D14/146
- D491,551 S * 6/2004 Matsui et al. D14/159
- D500,479 S * 1/2005 Senda et al. D14/130
- D500,751 S * 1/2005 Yukikado et al. D14/159

FOREIGN PATENT DOCUMENTS

- JP D739708-1 * 8/1988
- JP D749952 * 11/1988
- JP D805206 * 1/1991
- JP D1088480 * 10/2000
- JP D1126759 * 11/2001
- JP D1127988 * 12/2001
- JP D1142263 * 5/2002
- JP D1193967 * 1/2004

* cited by examiner

Primary Examiner—Cathron C. Brooks

Assistant Examiner—Austin Murphy

(74) *Attorney, Agent, or Firm*—Brinks Hofer Gilson & Lione

(57) **CLAIM**

We claim the ornamental design for an outdoor intercom unit, as shown and described.

DESCRIPTION

FIG. 1 is a front perspective view of an outdoor intercom unit of the present invention;
FIG. 2 is a front view thereof;
FIG. 3 is a bottom view thereof;
FIG. 4 is a top view thereof;
FIG. 5 is a first side view thereof;
FIG. 6 is a second side view thereof; and,
FIG. 7 is a rear view thereof.

1 Claim, 4 Drawing Sheets

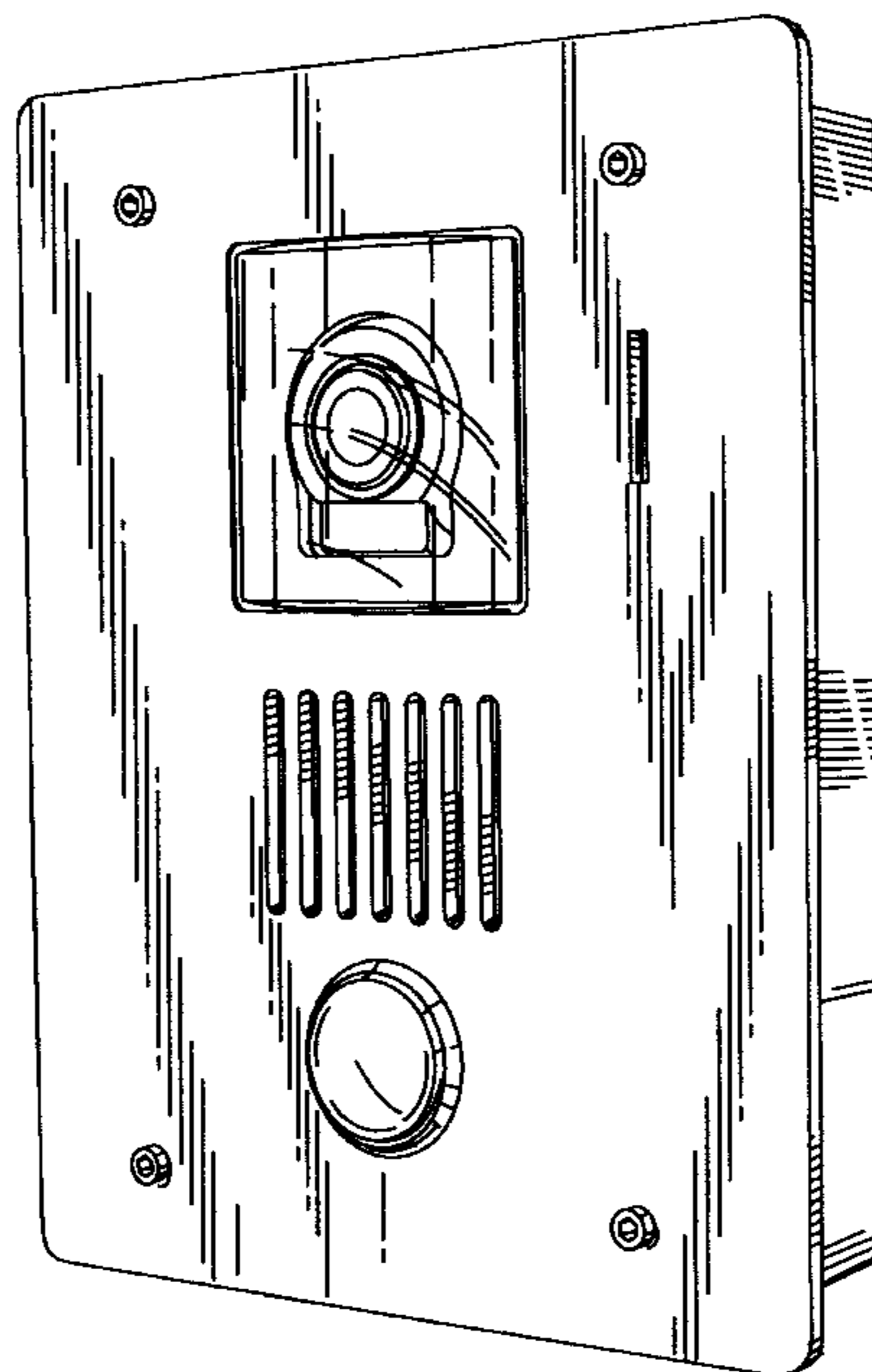

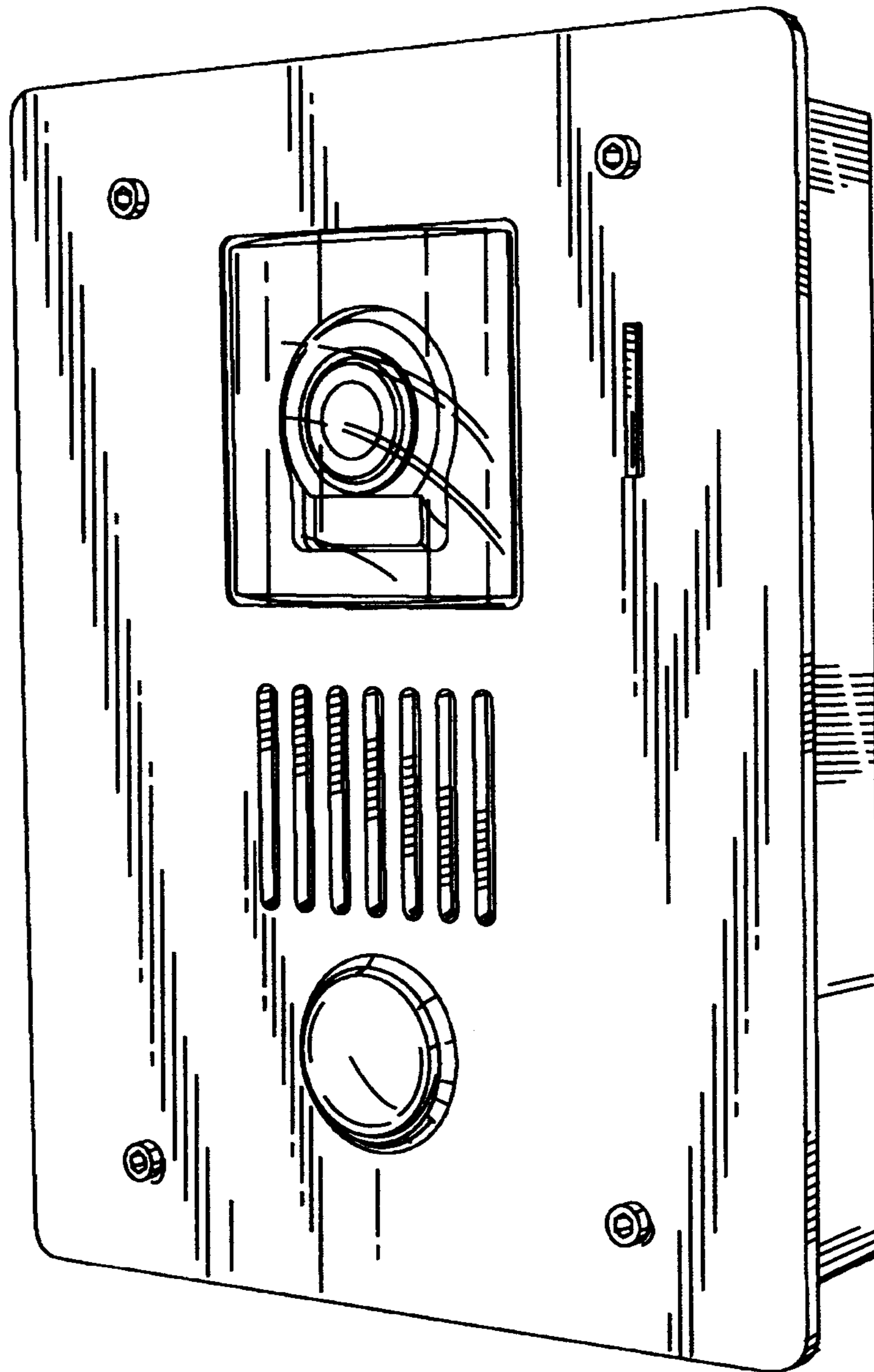

FIG. 1

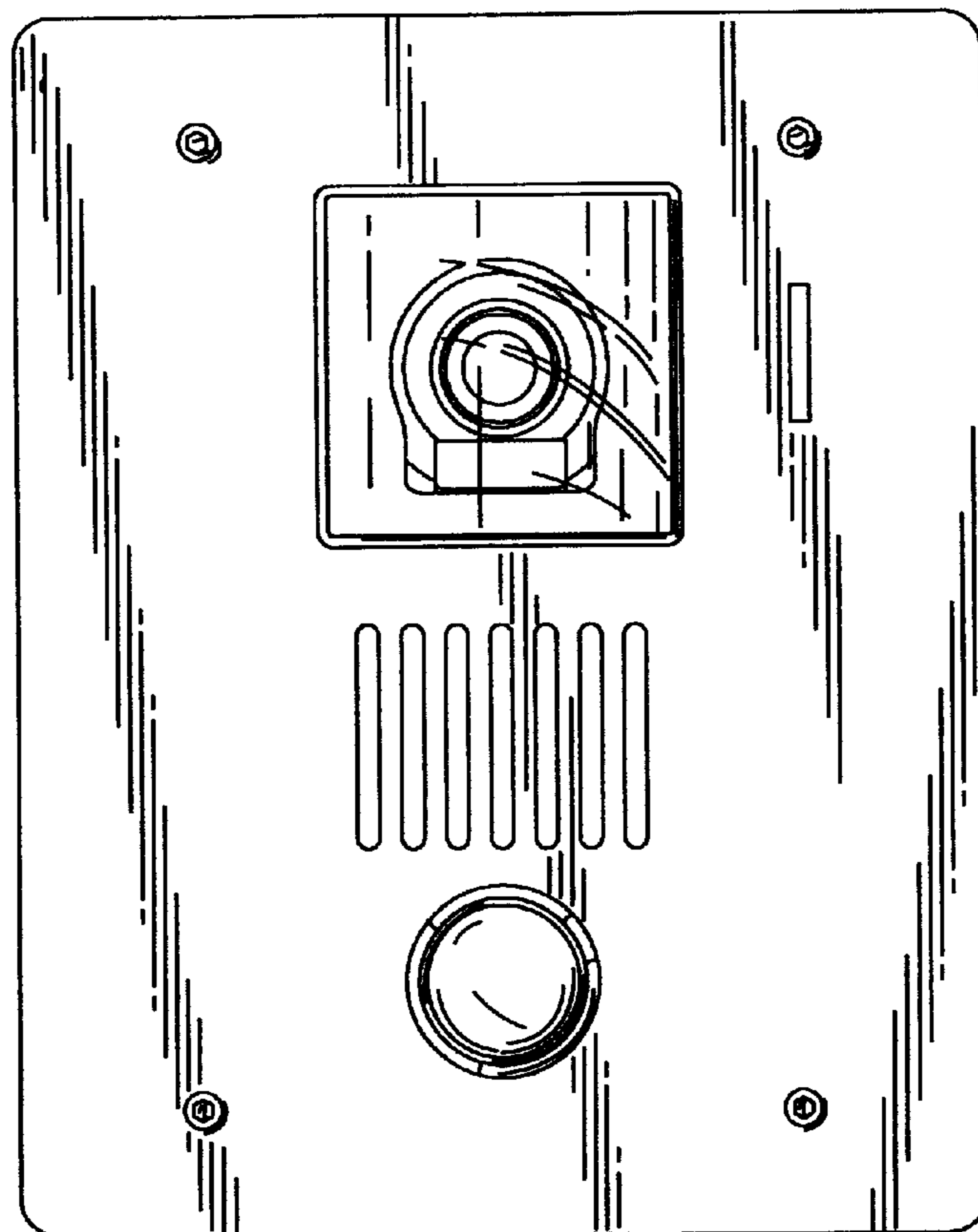

FIG. 2

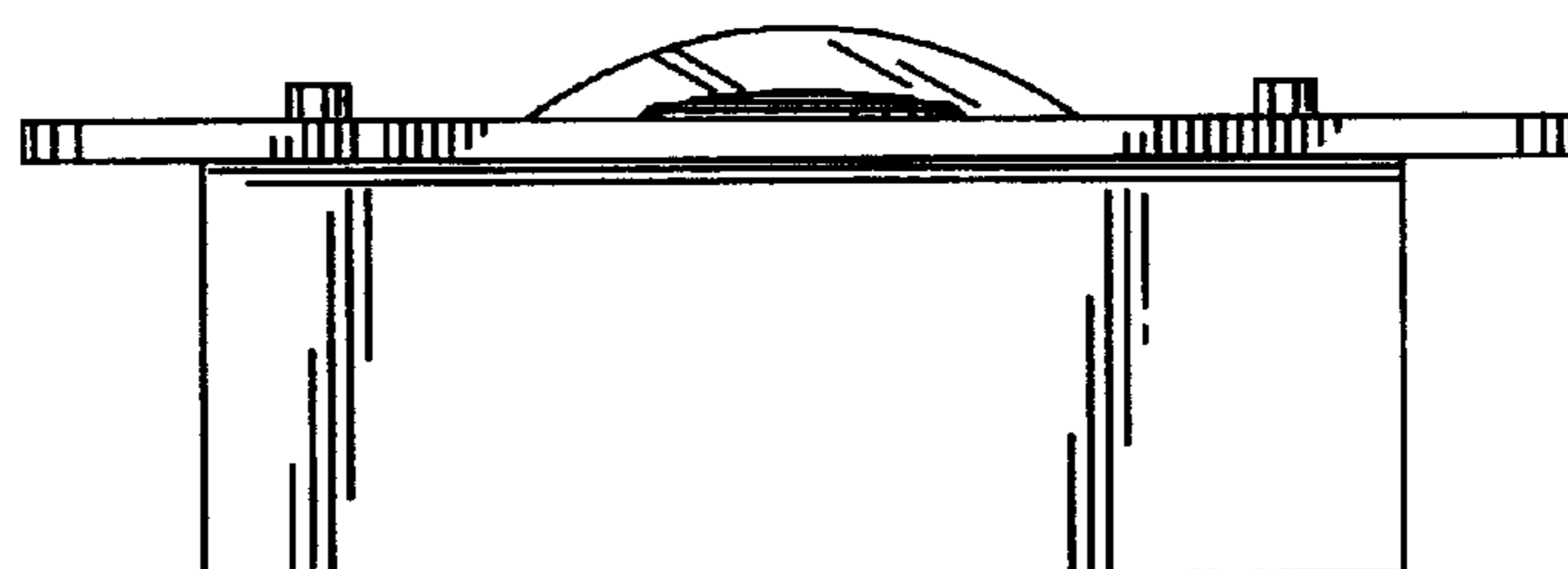

FIG. 3

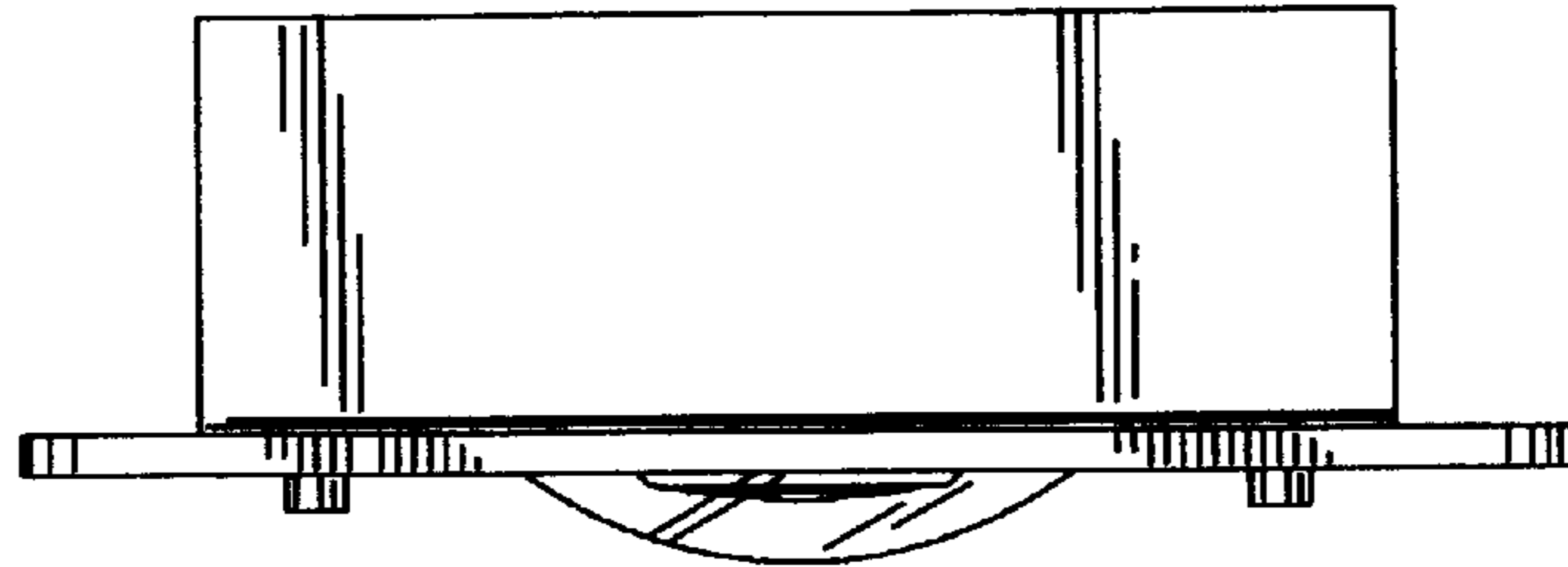

FIG. 4

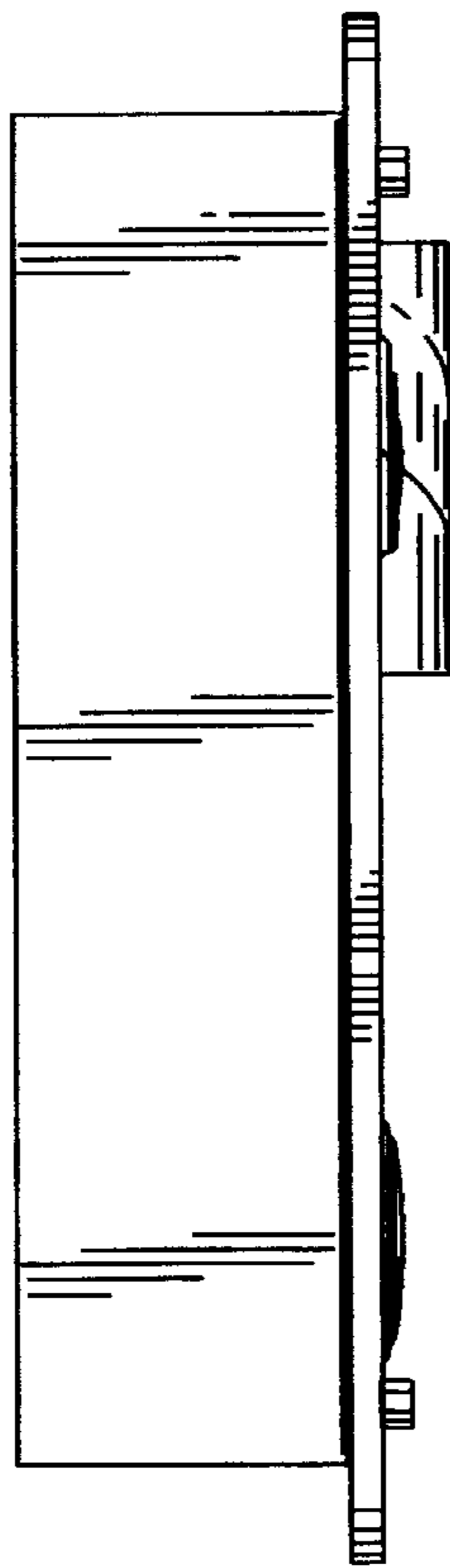

FIG. 5

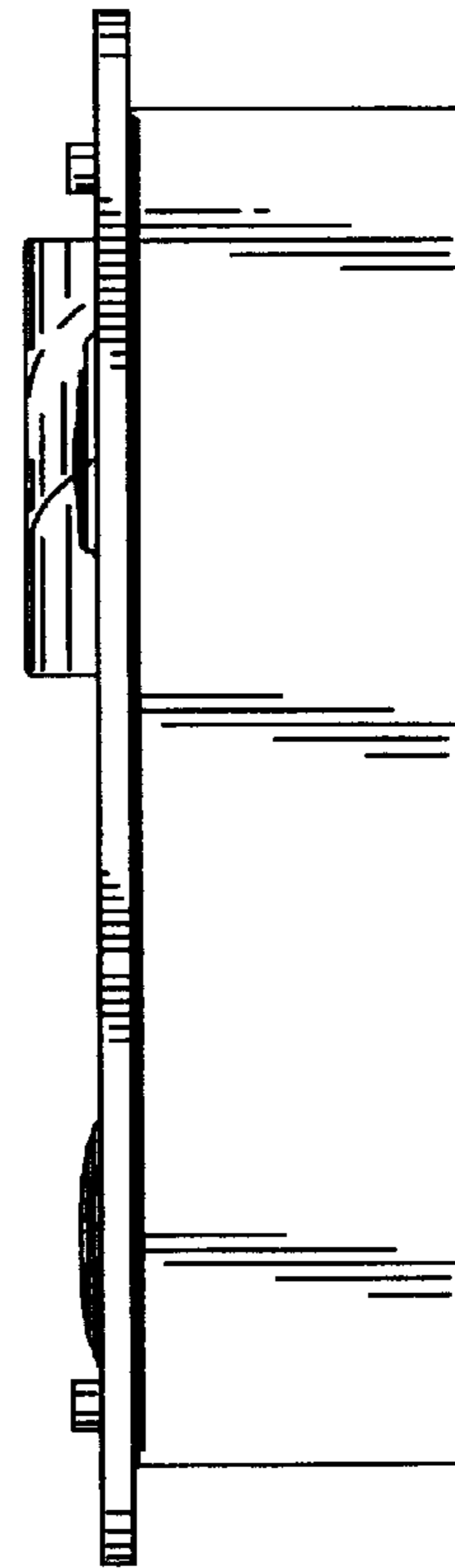

FIG. 6

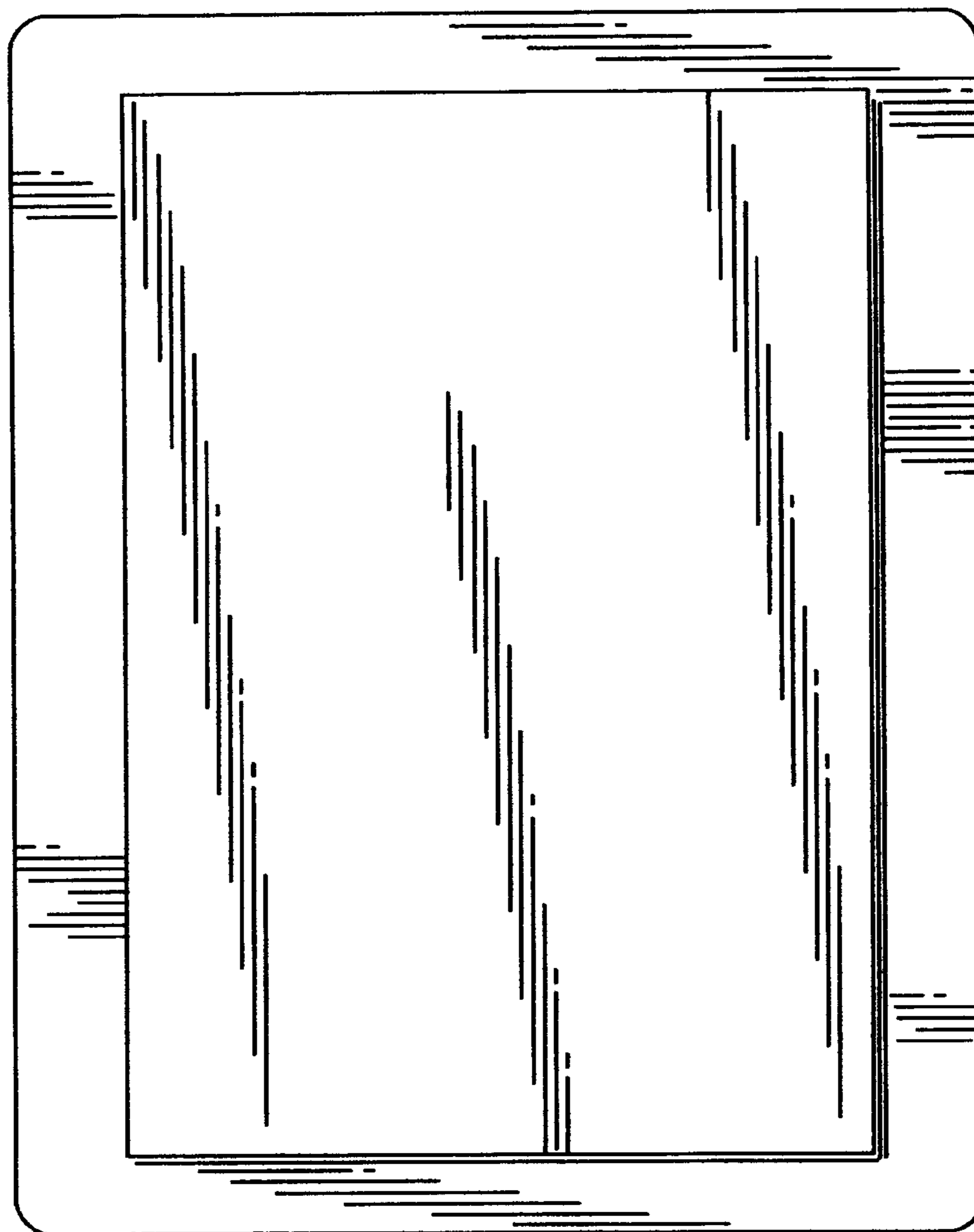

FIG. 7