

US00D522409S

(12) **United States Design Patent**  
**Wittkowski**

(10) **Patent No.:** **US D522,409 S**  
(45) **Date of Patent:** **\*\* Jun. 6, 2006**

- (54) **TANDEM AXLE TRAILER**
- (75) Inventor: **Donald Richard Wittkowski**, Sullivan, IL (US)
- (73) Assignee: **Agri-Fab Inc.**, Sullivan, IL (US)
- (\*\*) Term: **14 Years**
- (21) Appl. No.: **29/241,350**
- (22) Filed: **Oct. 26, 2005**

- D414,720 S \* 10/1999 Everett ..... D12/101
- D418,451 S \* 1/2000 Konecheck ..... D12/101
- 6,378,893 B1 \* 4/2002 Jager ..... 280/656
- D469,388 S \* 1/2003 Mighell ..... D12/101
- D471,845 S \* 3/2003 Mighell ..... D12/101

\* cited by examiner

*Primary Examiner*—Melody N. Brown  
(74) *Attorney, Agent, or Firm*—Vedder Price Kaufman & Kammholz

**Related U.S. Application Data**

- (62) Division of application No. 29/205,525, filed on May 17, 2004.
- (51) **LOC (8) Cl.** ..... **12-10**
- (52) **U.S. Cl.** ..... **D12/101**
- (58) **Field of Classification Search** ..... D12/101,  
D12/102; 280/475, 656, 763.1, 482, 462;  
296/181.2, 181.3  
See application file for complete search history.

**References Cited**

**U.S. PATENT DOCUMENTS**

- D369,328 S \* 4/1996 Acosta ..... D12/101
- D376,564 S \* 12/1996 Mishoe ..... D12/101

(57) **CLAIM**

The ornamental design for a tandem axle trailer, as shown and described.

**DESCRIPTION**

FIG. 1 is a perspective view of the tandem axle trailer showing my new design;  
FIG. 2 is a front view of my design;  
FIG. 3 is a rear view of my design;  
FIG. 4 is a view of one side of my design;  
FIG. 5 is a view of the other side of my design;  
FIG. 6 is a top view of my design; and,  
FIG. 7 is a bottom view of my design.  
The rail shown in broken lines is for illustrative purposes only and forms no part of the claimed design.

**1 Claim, 4 Drawing Sheets**

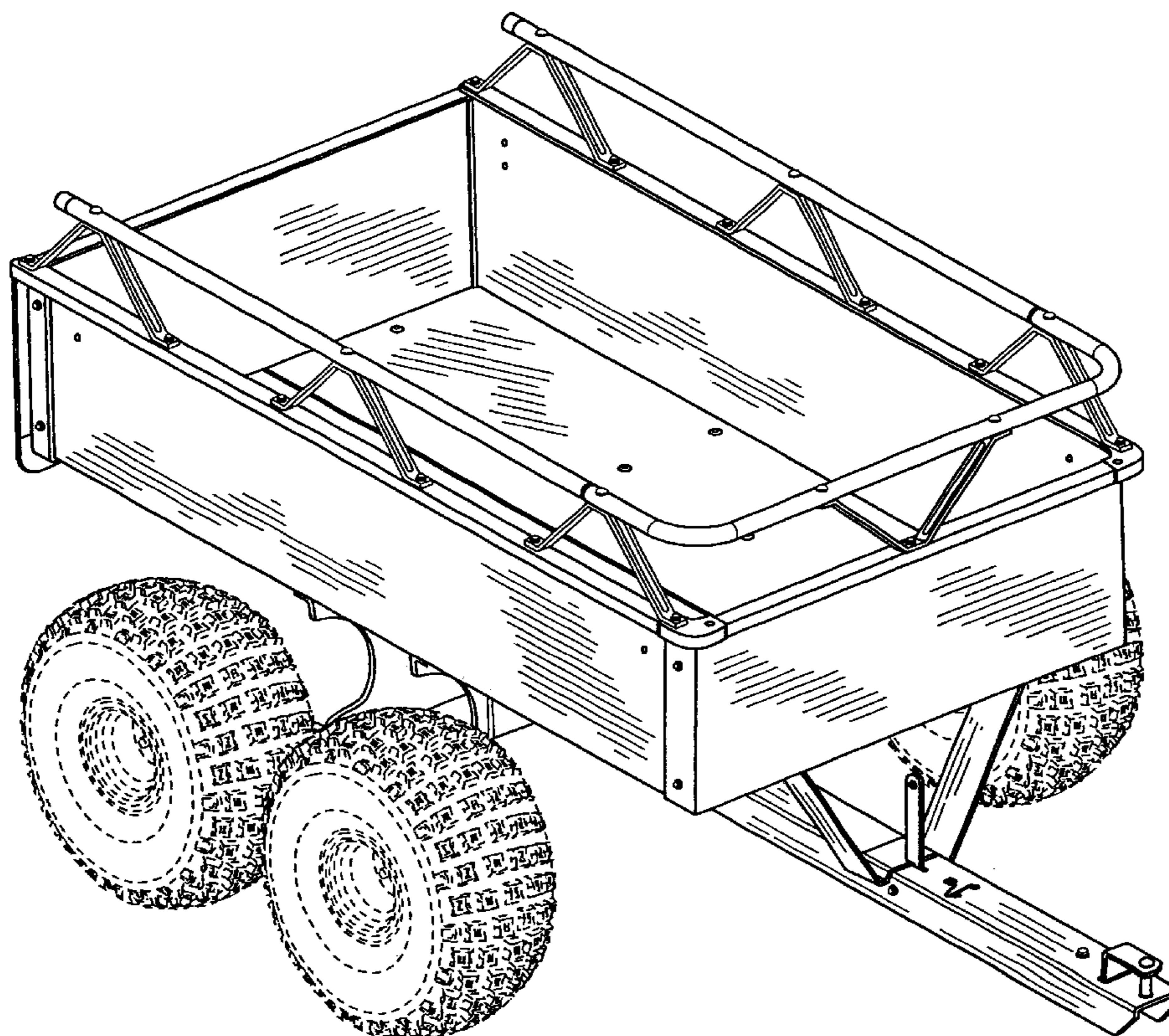

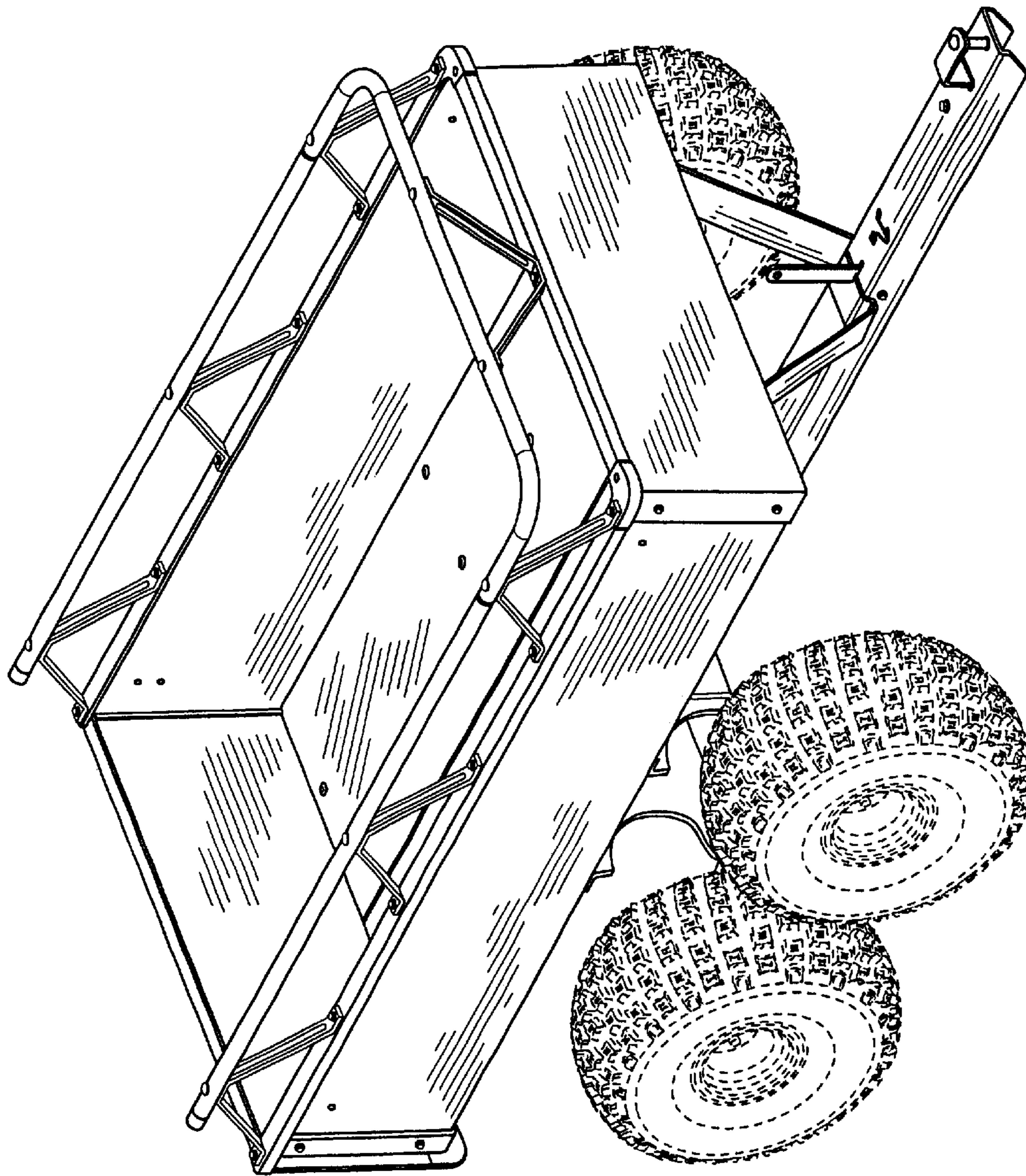

FIG. 1

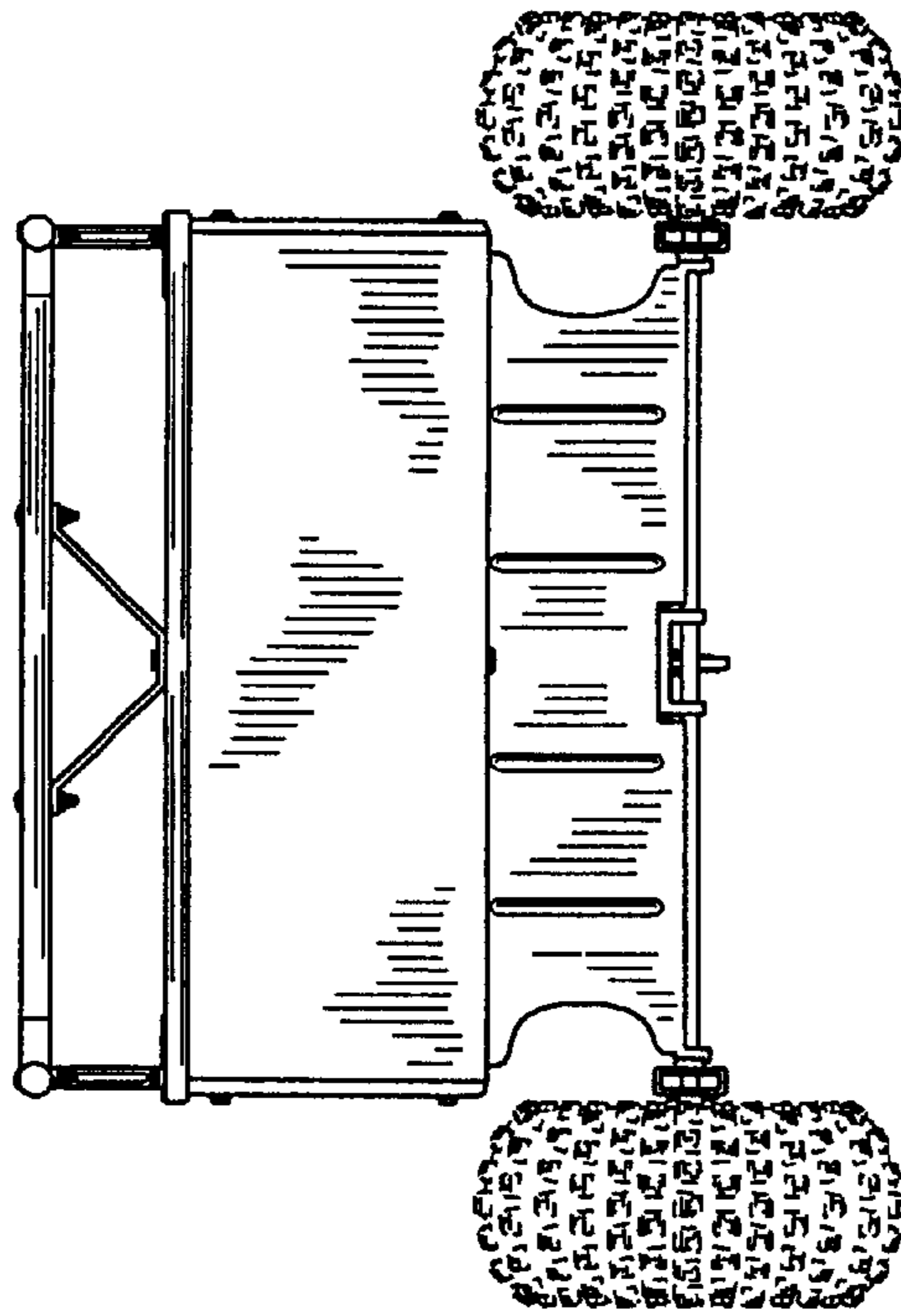

FIG. 3

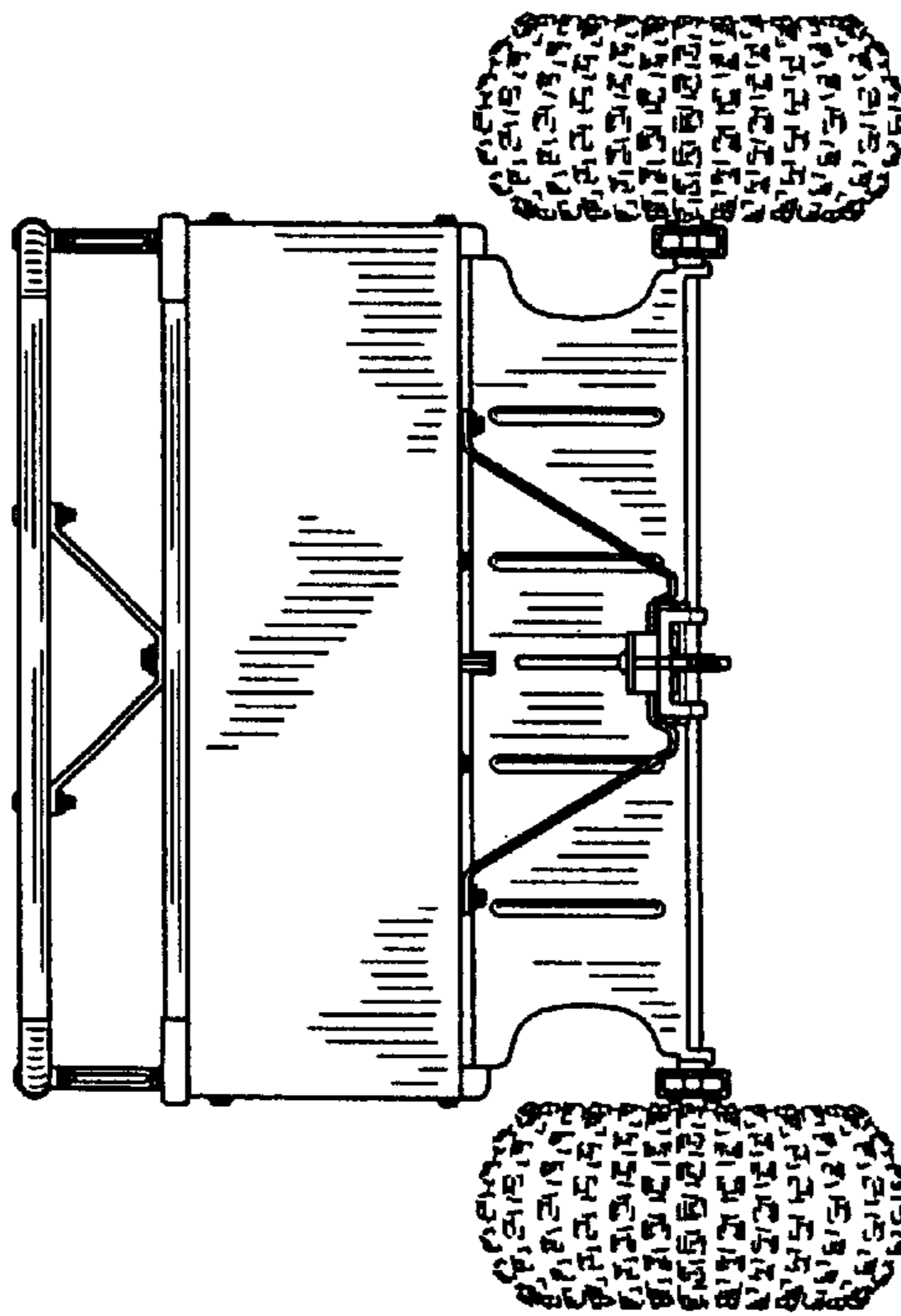

FIG. 2

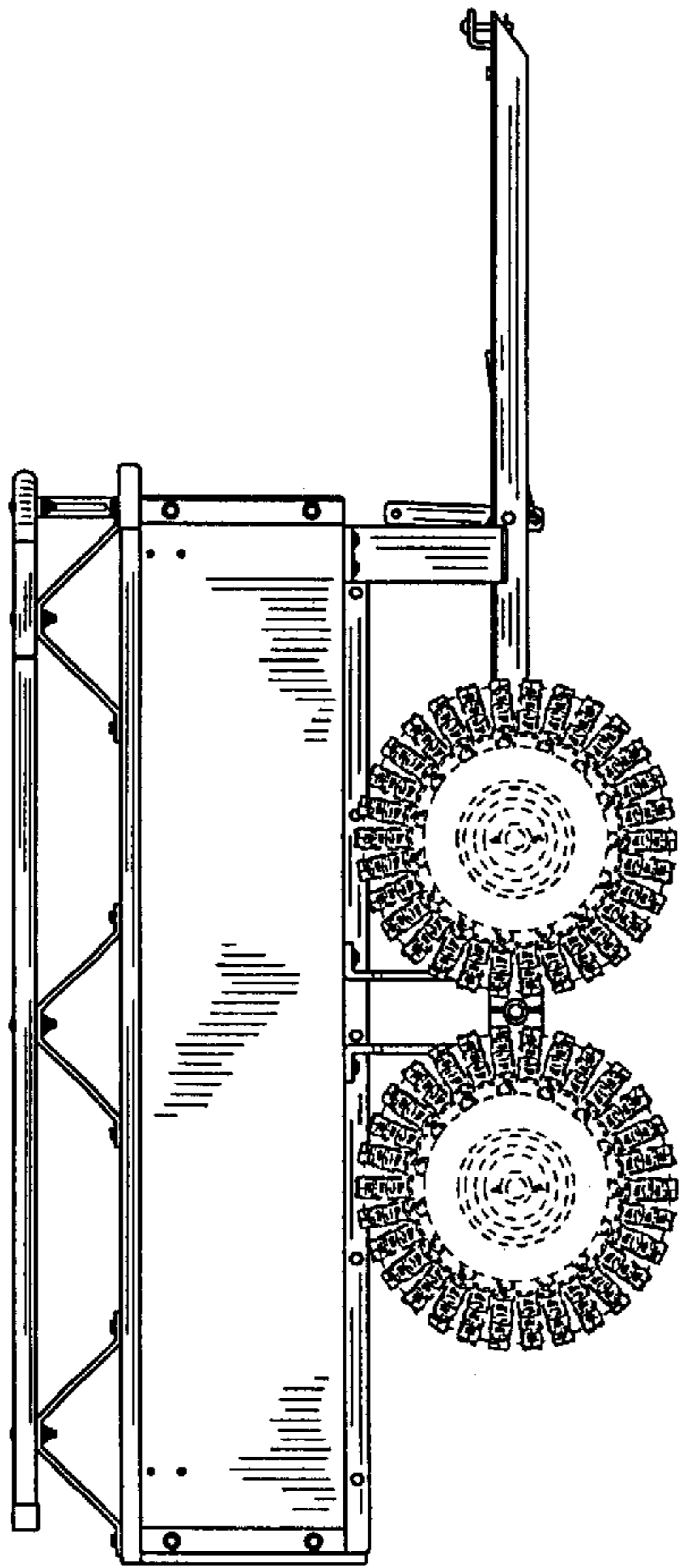

FIG. 4

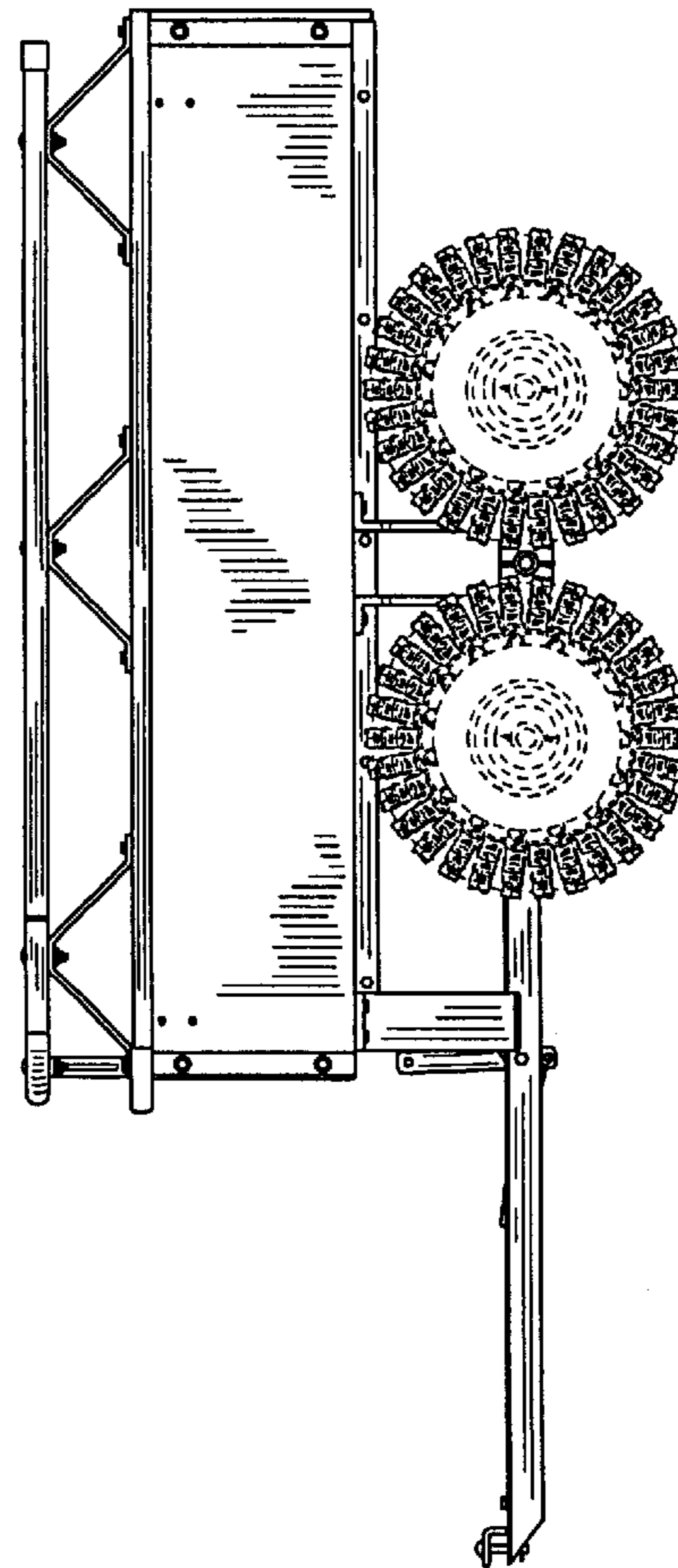

FIG. 5

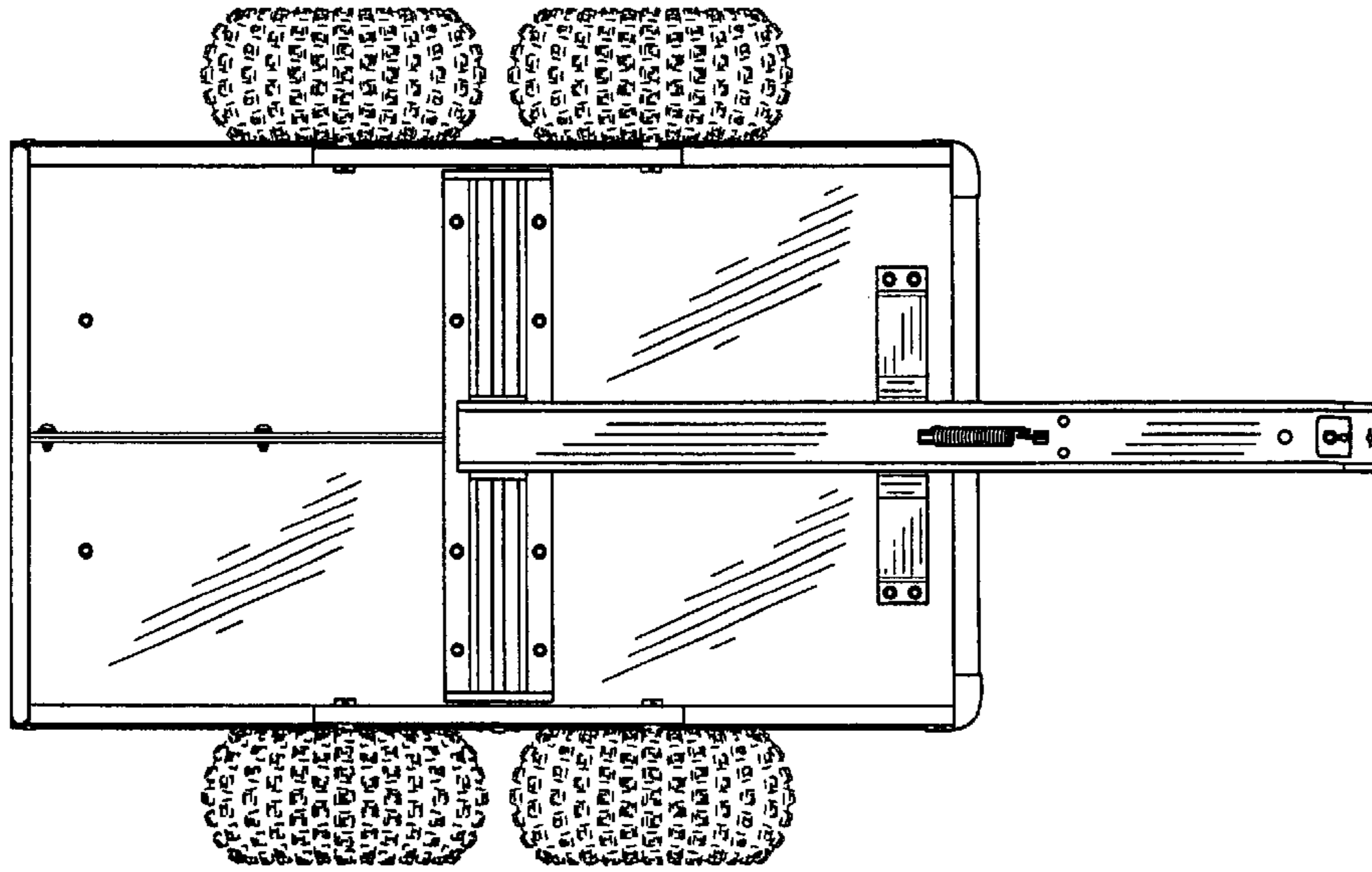

FIG. 7

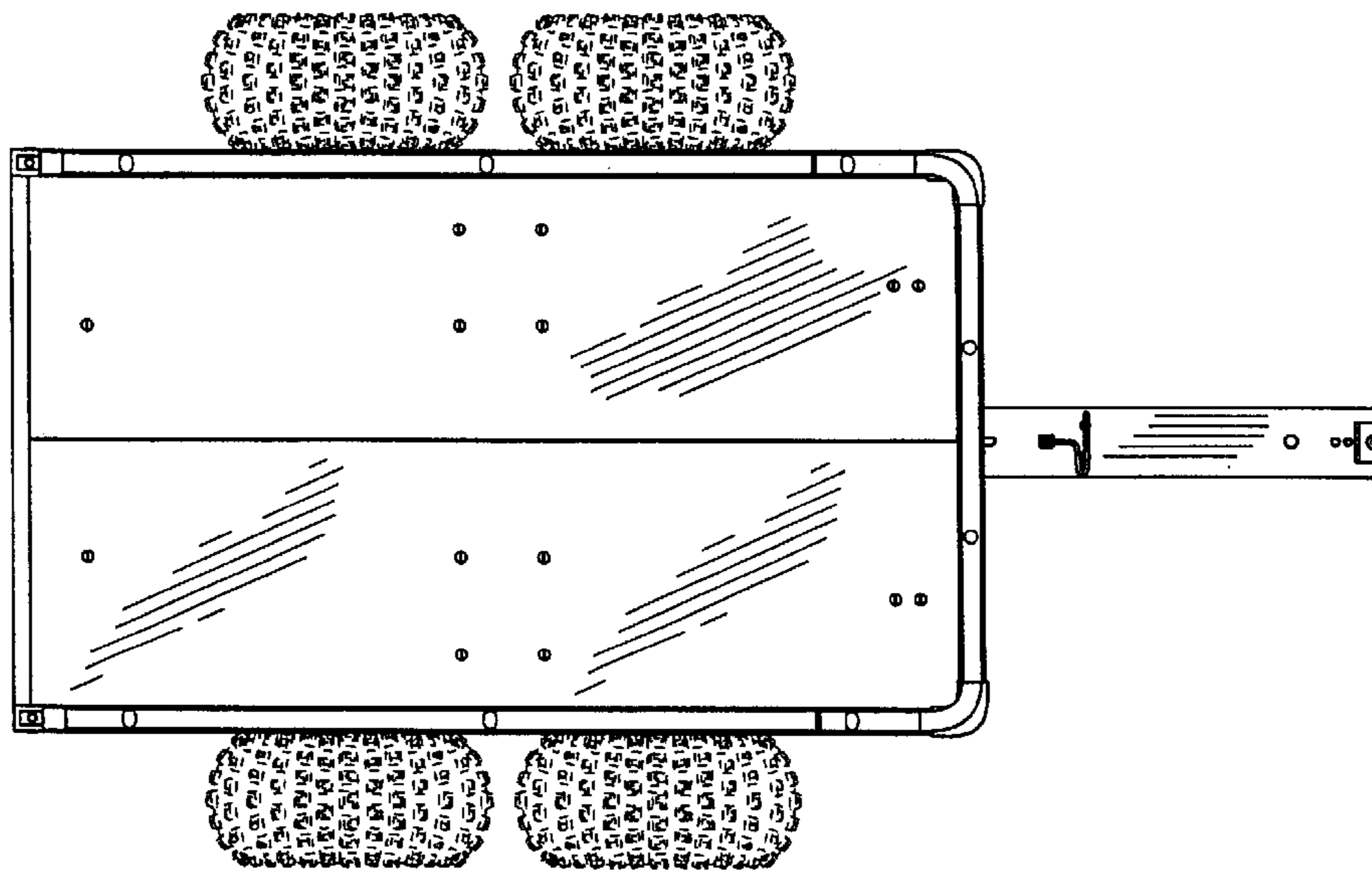

FIG. 6