



US00D522396S

(12) **United States Design Patent**
Hollis

(10) **Patent No.:** **US D522,396 S**
(45) **Date of Patent:** **** Jun. 6, 2006**

(54) **JEWELRY**

- (75) Inventor: **Mark Hollis**, Darien, CT (US)
- (73) Assignee: **SalesOne, LLC**, Stamford, CT (US)
- (**) Term: **14 Years**
- (21) Appl. No.: **29/229,527**
- (22) Filed: **May 9, 2005**

Related U.S. Application Data

- (62) Division of application No. 29/183,134, filed on Jun. 6, 2003, now Pat. No. Des. 508,658.
- (51) **LOC (8) Cl.** **11-01**
- (52) **U.S. Cl.** **D11/1**
- (58) **Field of Classification Search** D11/1,
D11/2, 26, 75, 43; 63/3, 12, 13, 29.1; 473/52,
473/53, 125, 351; 273/58 R; D21/708, 466
See application file for complete search history.

(56) **References Cited**

U.S. PATENT DOCUMENTS

D206,346 S	11/1966	Steinman	D11/75
5,638,700 A *	6/1997	Shechter	63/12
5,946,943 A *	9/1999	Hanson	63/12
6,026,659 A	2/2000	Kaping, Jr.	63/12
6,244,073 B1	6/2001	Kaping, Jr.	63/12
D460,014 S	7/2002	Williams et al.	D11/1
6,470,709 B1 *	10/2002	Siekierski	63/12
D468,494 S	1/2003	Holloway	D11/1
D471,478 S	3/2003	Waldman	D11/1
D472,838 S	4/2003	Ziller	D11/1
D474,418 S	5/2003	Waldman	D11/1
D480,657 S	10/2003	Waldman	D11/1
6,675,613 B1	1/2004	Ashton	63/12
2004/0123625 A1	7/2004	Waldman et al.	63/12

OTHER PUBLICATIONS

Sunshine Jewelry Catalog 2003; p. 3; bottom left side of page; from Google Catalogs.*
 Ipso Facto Catalog 2002; p.9; middle right side of page; from Google Catalogs.*
 Eurosport Catalog Jan.–Feb. 2004; p. 65; upper middle of page; from Google Catalogs.*
 Fingerhut Catalog Jan. 2004; p. 155; botom right corner of page; from Google Catalogs.*
 Pleasurable Piercings Catalog 2002; p. 7; upper right corner of page and middle left side of page; from Google Catalogs.*

Pleasurable Piercing Catalogue 2002. Copyright 2000. Pg. 14; middle of the left side of page; from Google Catalogues.

* cited by examiner

Primary Examiner—Ian Simmons

Assistant Examiner—Melanie Levy

(74) *Attorney, Agent, or Firm*—Ohlandt, Greeley, Ruggiero & Perle, L.L.P.

(57) **CLAIM**

The ornamental design for jewelry, as shown and described.

DESCRIPTION

FIG. 1 is a perspective view of a first embodiment of jewelry showing my new design;
 FIG. 2 is a perspective view of a second embodiment of jewelry showing my new design;
 FIG. 3 is a perspective view of a third embodiment of jewelry showing my new design;
 FIG. 4 is a perspective view of a fourth embodiment of jewelry showing my new design;
 FIG. 5 is a perspective view of a fifth embodiment of jewelry showing my new design; and,
 FIG. 6 is a perspective view of an sixth embodiment of jewelry showing my new design.

1 Claim, 3 Drawing Sheets

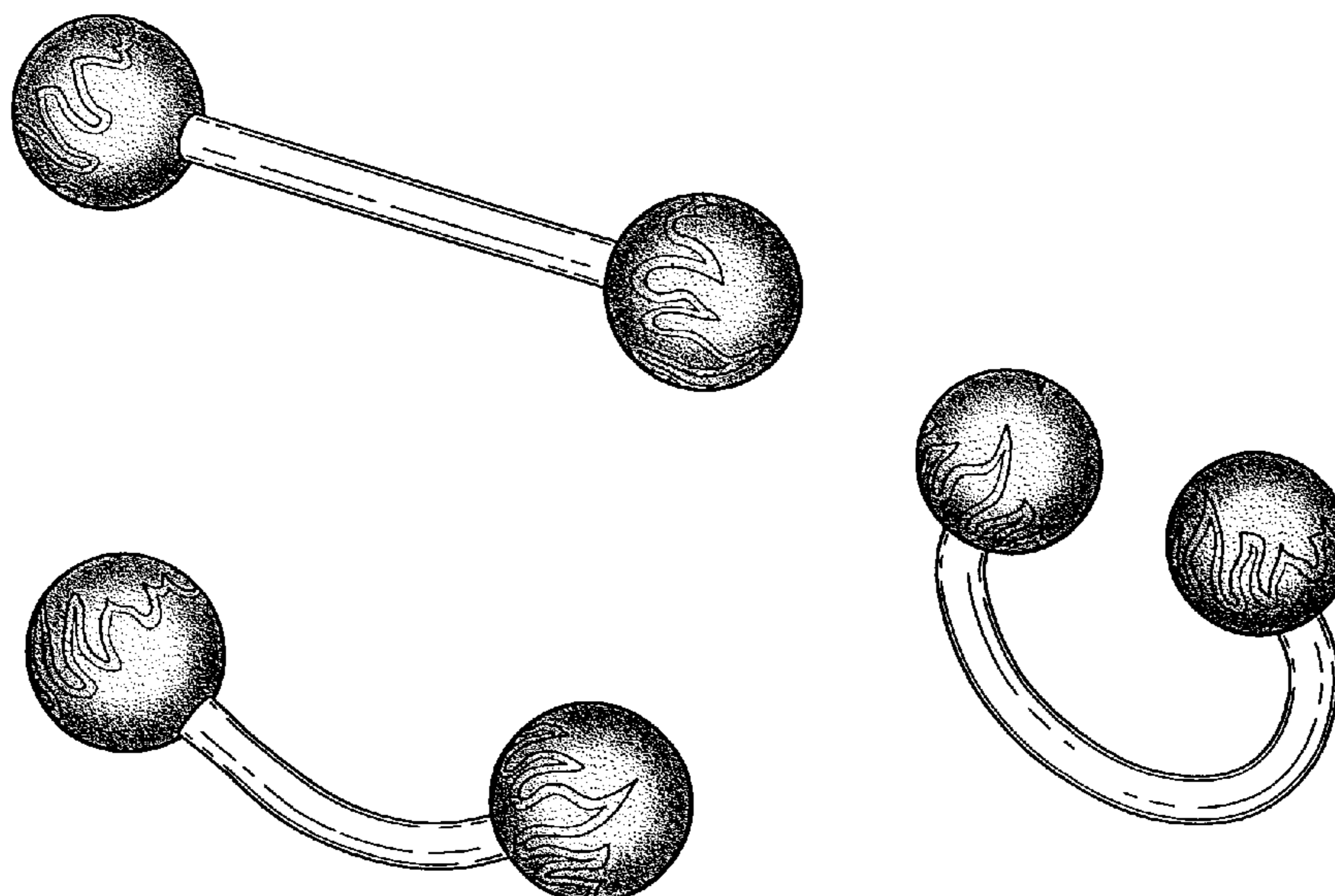

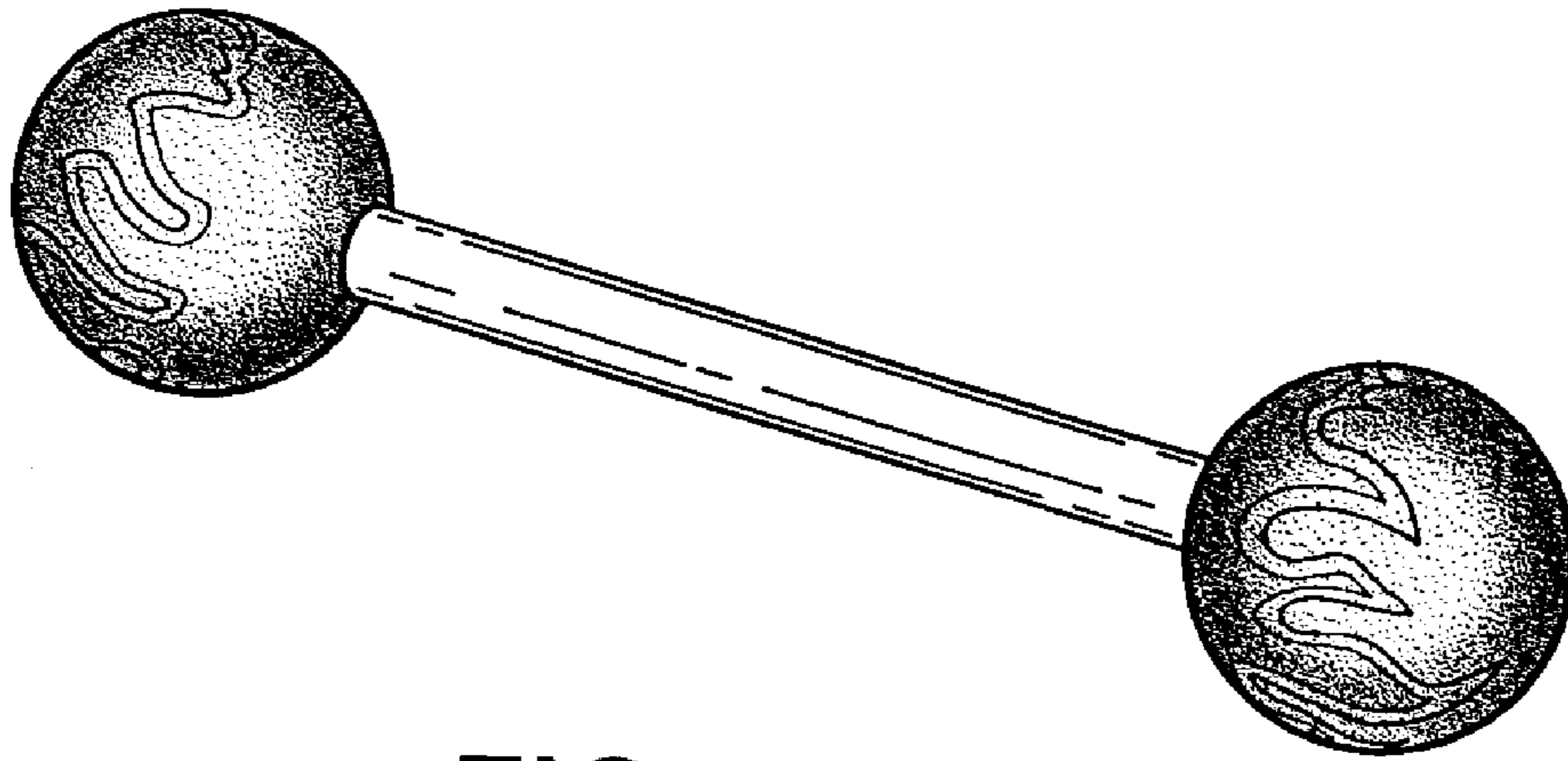

FIG. 1

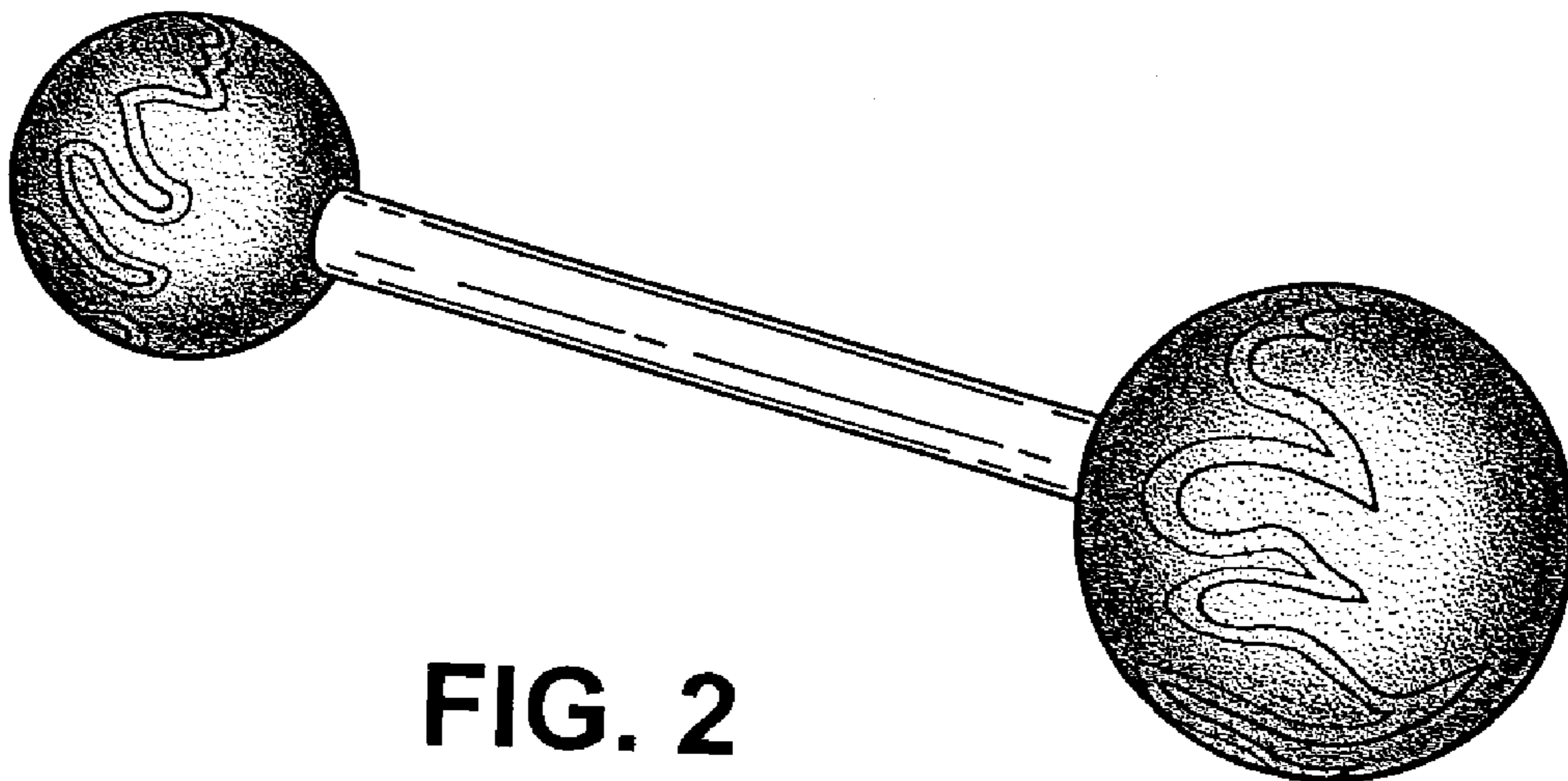

FIG. 2

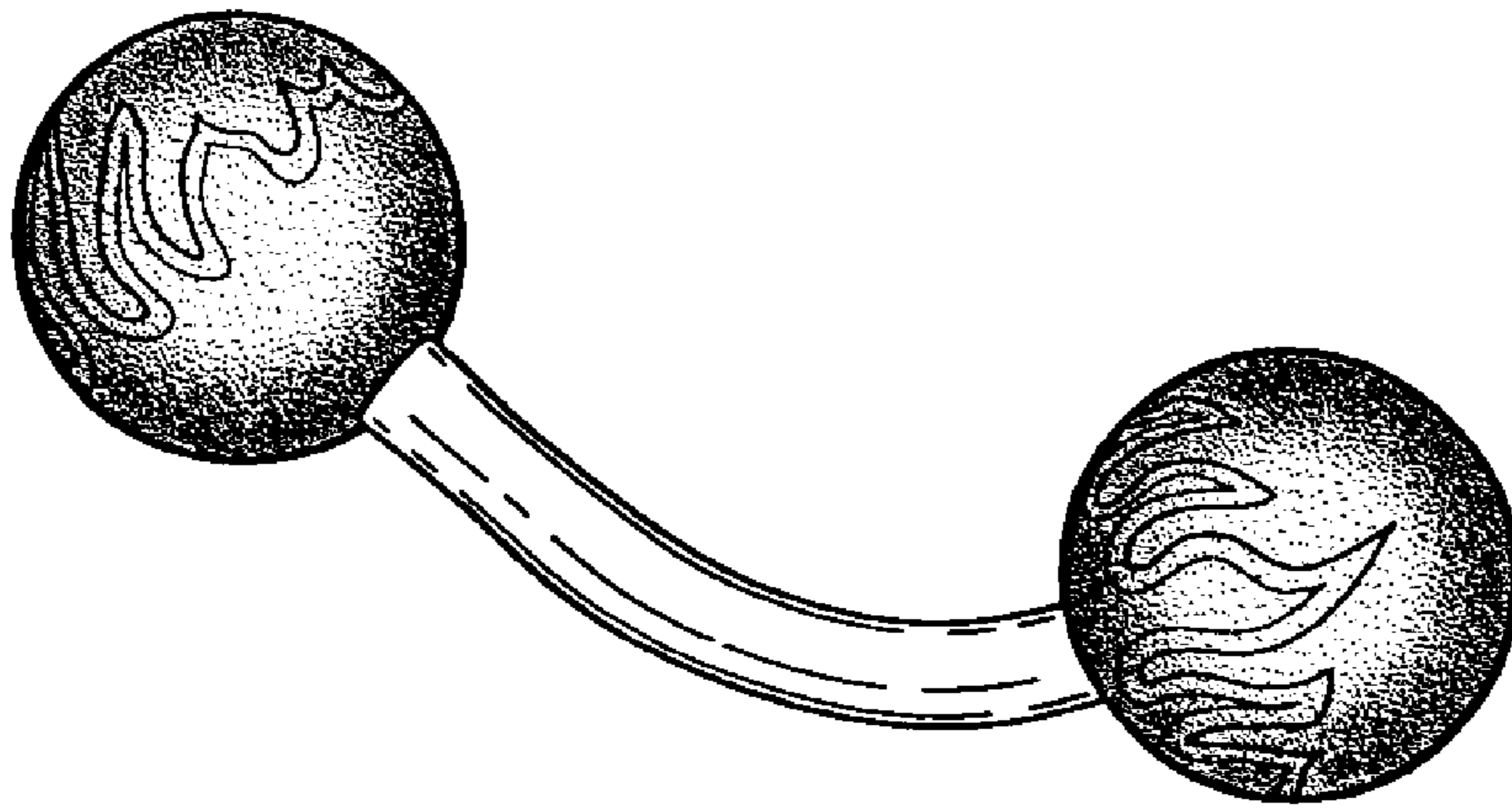

FIG. 3

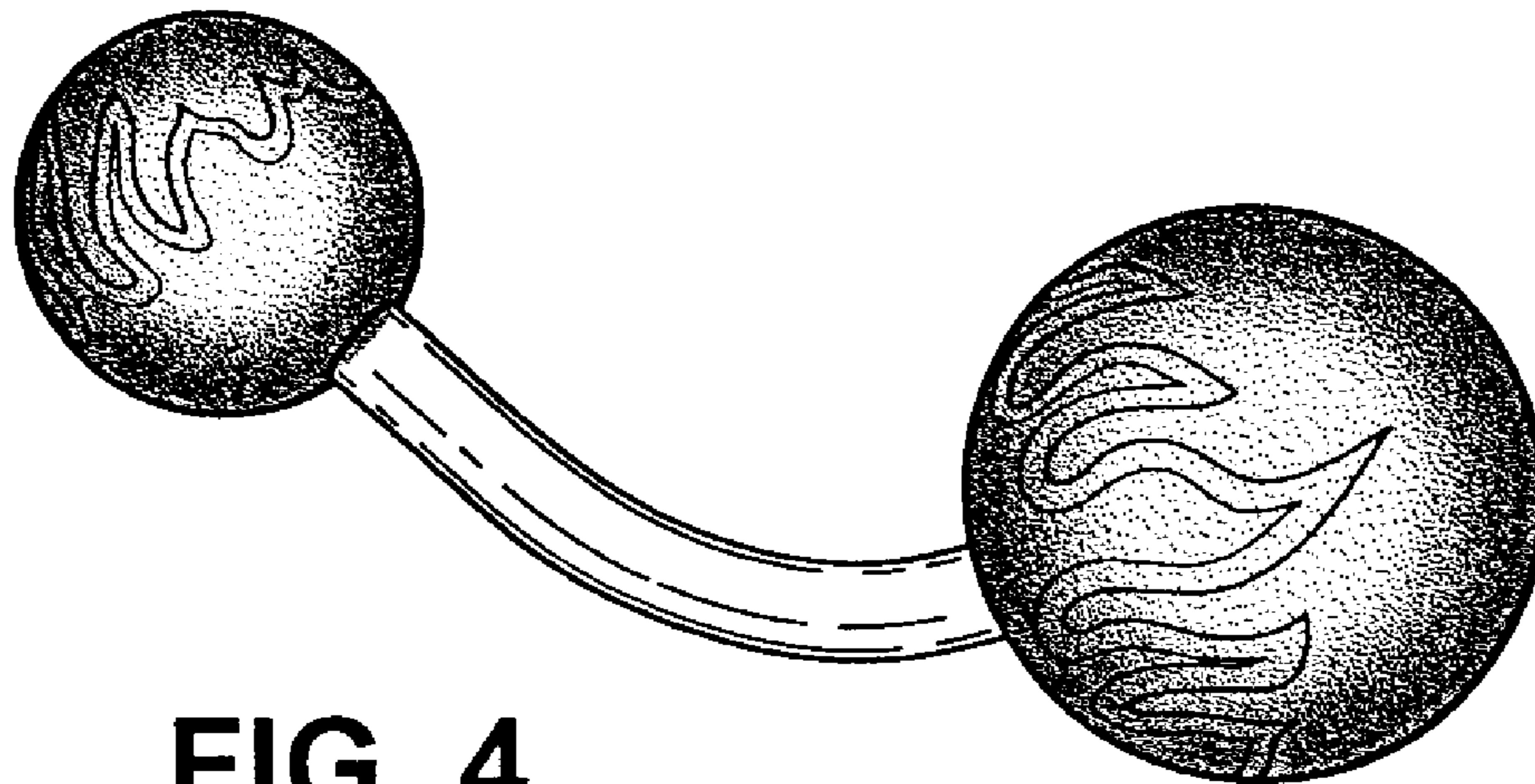

FIG. 4

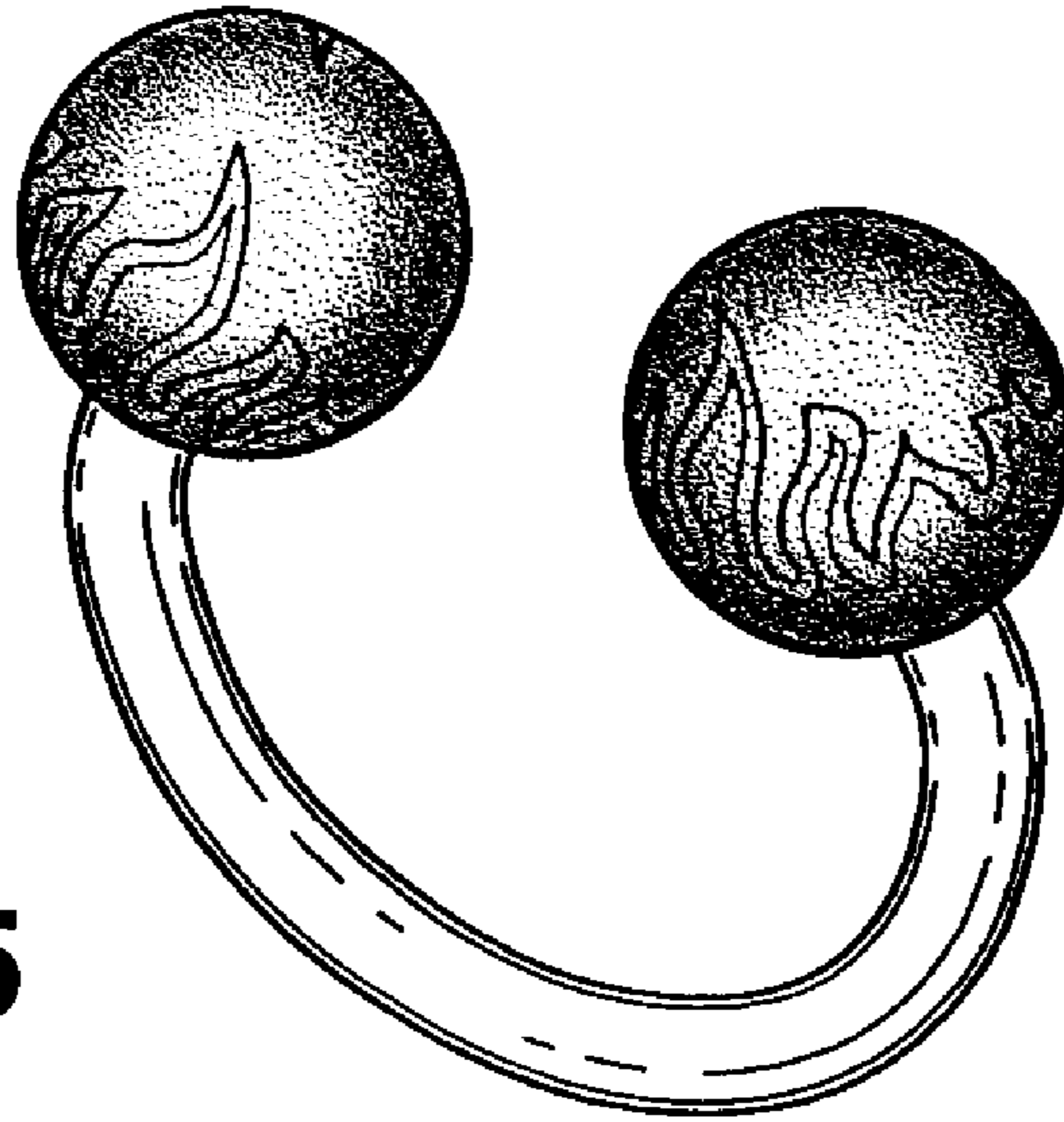

FIG. 5

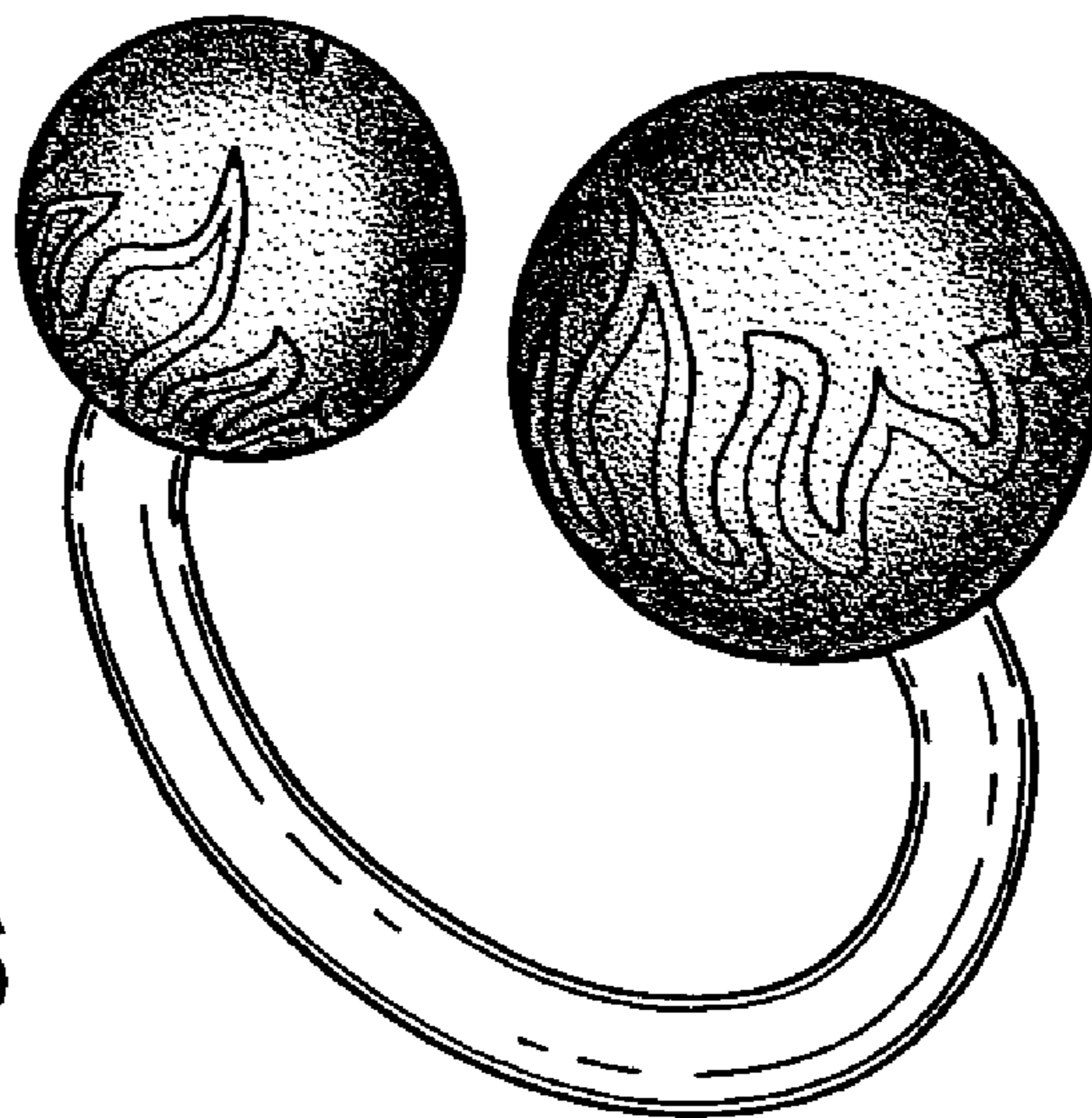

FIG. 6