

US00D522380S

(12) **United States Design Patent** (10) **Patent No.:** **US D522,380 S**  
**Dibnah et al.** (45) **Date of Patent:** **\*\* Jun. 6, 2006**

(54) **PACKAGED COSMETIC KIT**  
(75) Inventors: **Carl Dibnah**, Hull (GB); **Andrew Robert McLeish**, deceased, late of Sheffield (GB); by **Andrew Brown**, legal representative, Hull (GB); **Jean-Francois Lhoste**, Le Coudray (FR)  
(73) Assignee: **Reckitt Benckiser (UK) Limited**, Slough (GB)

(\*\*) Term: **14 Years**

(21) Appl. No.: **29/219,749**

(22) Filed: **Dec. 21, 2004**

(30) **Foreign Application Priority Data**

Jun. 25, 2004 (EM) ..... 000195755-0001

(51) **LOC (8) Cl.** ..... **09-03**

(52) **U.S. Cl.** ..... **D9/715**

(58) **Field of Classification Search** ..... D9/715, D9/718, 721, 735, 748, 414-418, 424, 499; D28/9, 10, 44.1, 444-54, 73, 99; 132/289; 206/207, 208, 228, 351, 352, 461-470  
See application file for complete search history.

(56) **References Cited**

**U.S. PATENT DOCUMENTS**

3,206,012 A \* 9/1965 Braginetz ..... 206/228  
3,352,630 A \* 11/1967 Fischer et al. .... 206/208

D216,635 S \* 2/1970 Grange ..... D9/748  
3,970,194 A \* 7/1976 Iten ..... 206/228  
D313,175 S \* 12/1990 Motta et al. .... D9/721  
D352,236 S \* 11/1994 Althaus ..... D9/415  
5,429,241 A \* 7/1995 Althaus ..... 206/352  
6,276,529 B1 \* 8/2001 Feehan, Jr. .... 206/352  
D496,267 S \* 9/2004 Tommassetti ..... D9/415  
D508,296 S \* 8/2005 Dibnah et al. .... D28/44  
D511,105 S \* 11/2005 Dominesey et al. .... D9/748  
D512,181 S \* 11/2005 Dibnah et al. .... D28/44  
2004/0118724 A1 \* 6/2004 Leventhal et al. .... 206/352

\* cited by examiner

*Primary Examiner*—Nanda Bondade

*Assistant Examiner*—Shanda C. Hill

(74) *Attorney, Agent, or Firm*—Norris McLaughlin & Marcus PA

(57) **CLAIM**

The ornamental design for a packaged cosmetic kit, as shown and described.

**DESCRIPTION**

FIG. 1 is a perspective view of a packaged cosmetic kit showing our new design;  
FIG. 2 is a front elevational view thereof;  
FIG. 3 is a rear elevational view thereof;  
FIG. 4 is a side elevational view thereof;  
FIG. 5 is a side elevational view thereof, opposite that which is shown in FIG. 4;  
FIG. 6 is a top plan view thereof; and,  
FIG. 7 is a bottom plan view thereof.

**1 Claim, 2 Drawing Sheets**

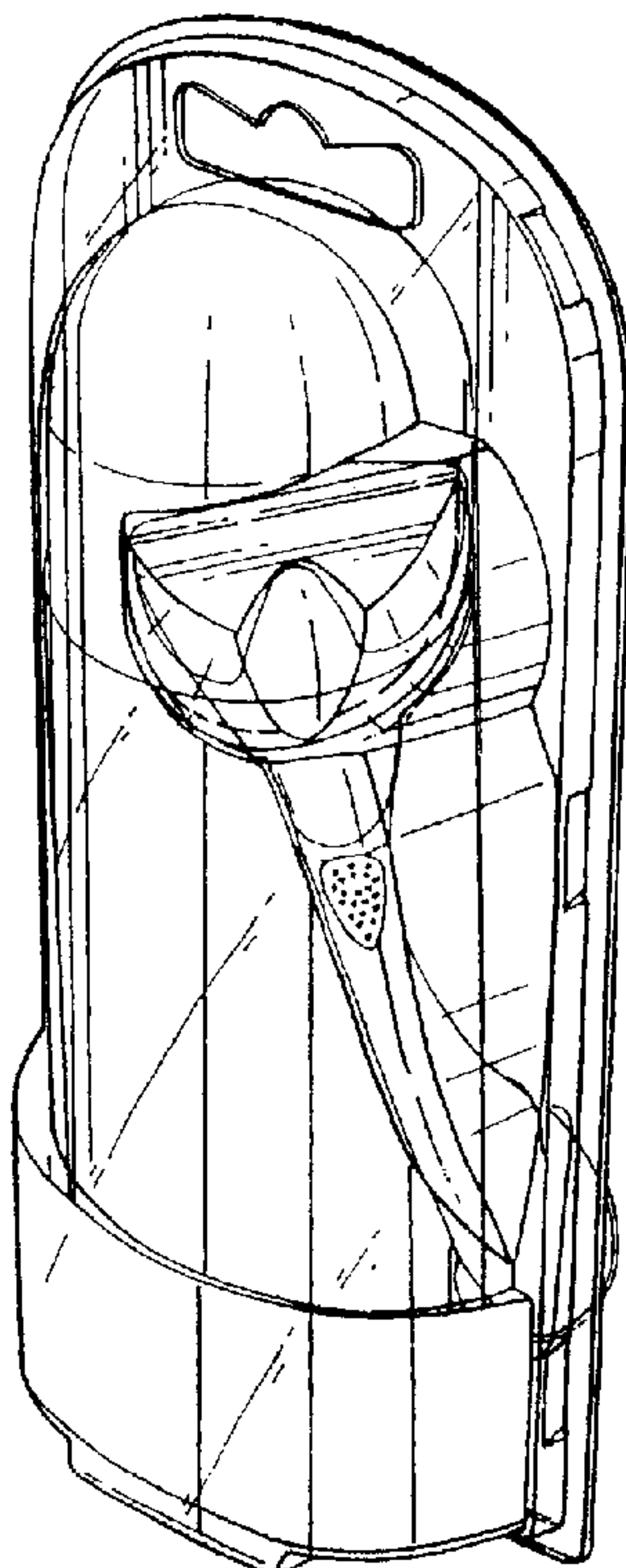

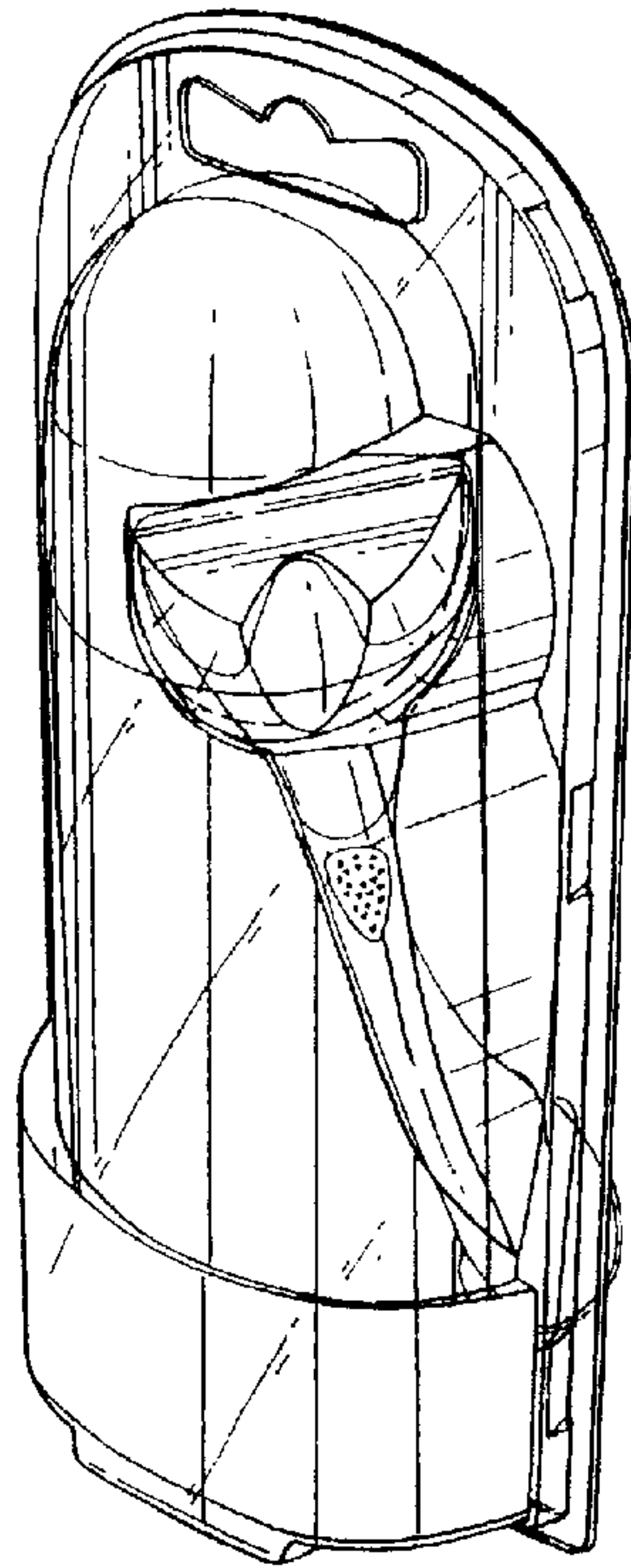

Fig. 1

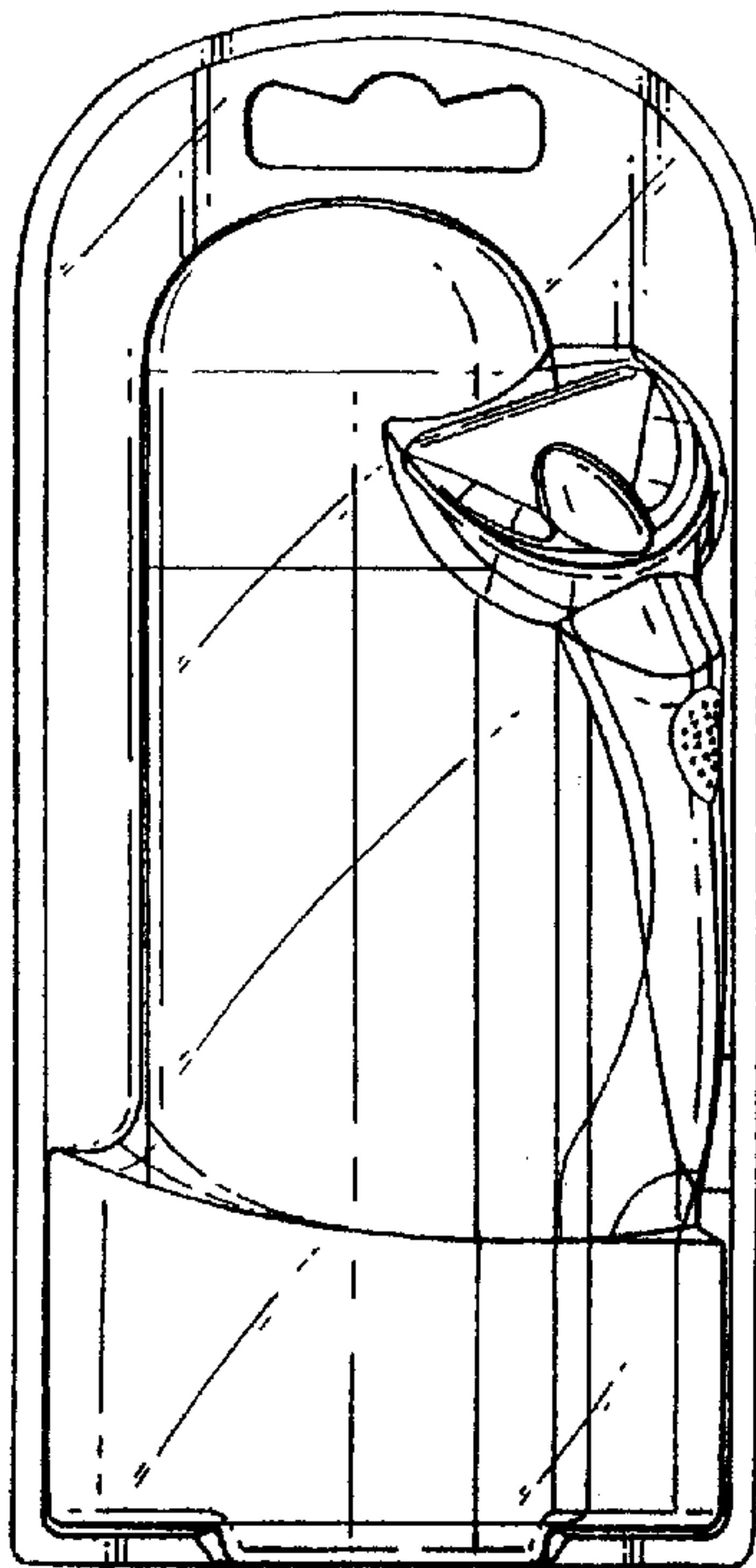

Fig. 2

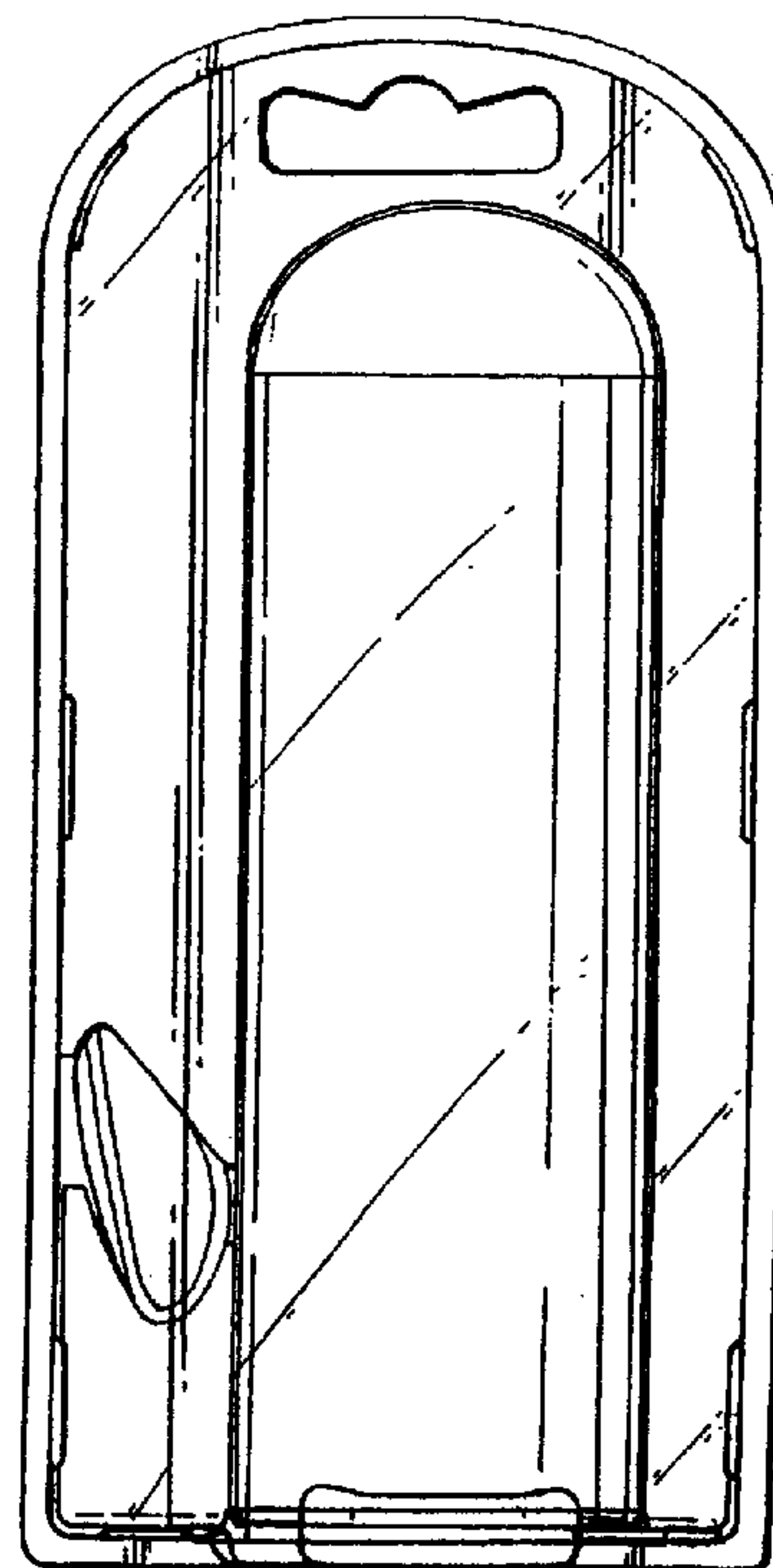

Fig. 3

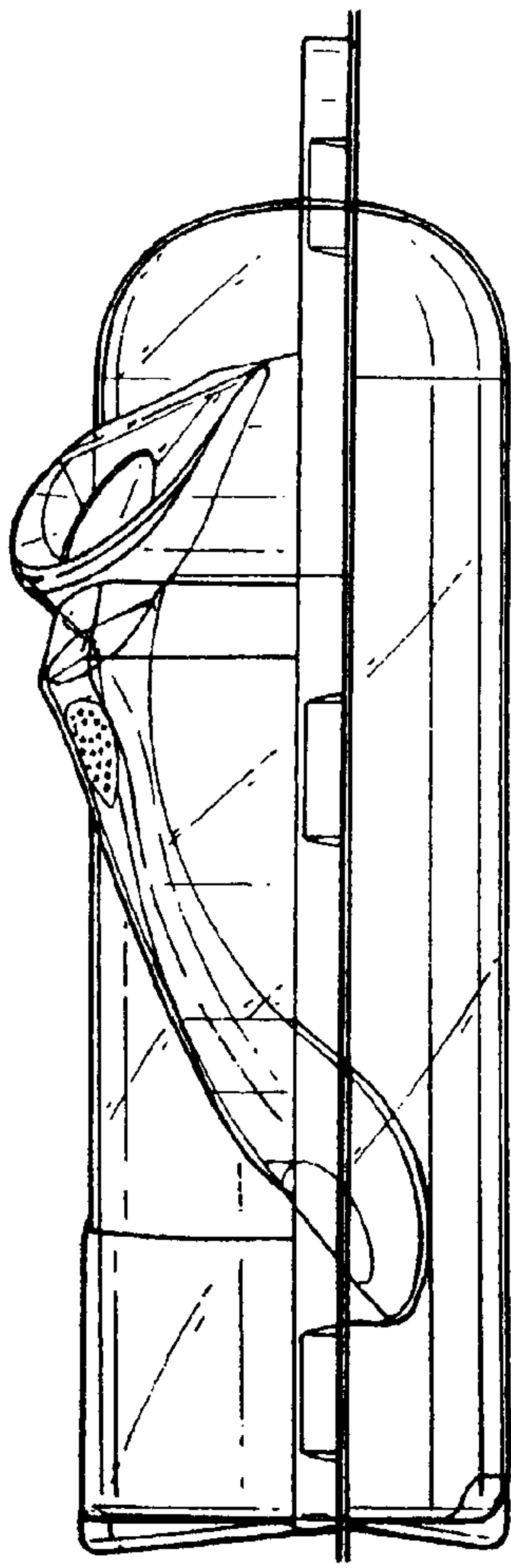

Fig. 4

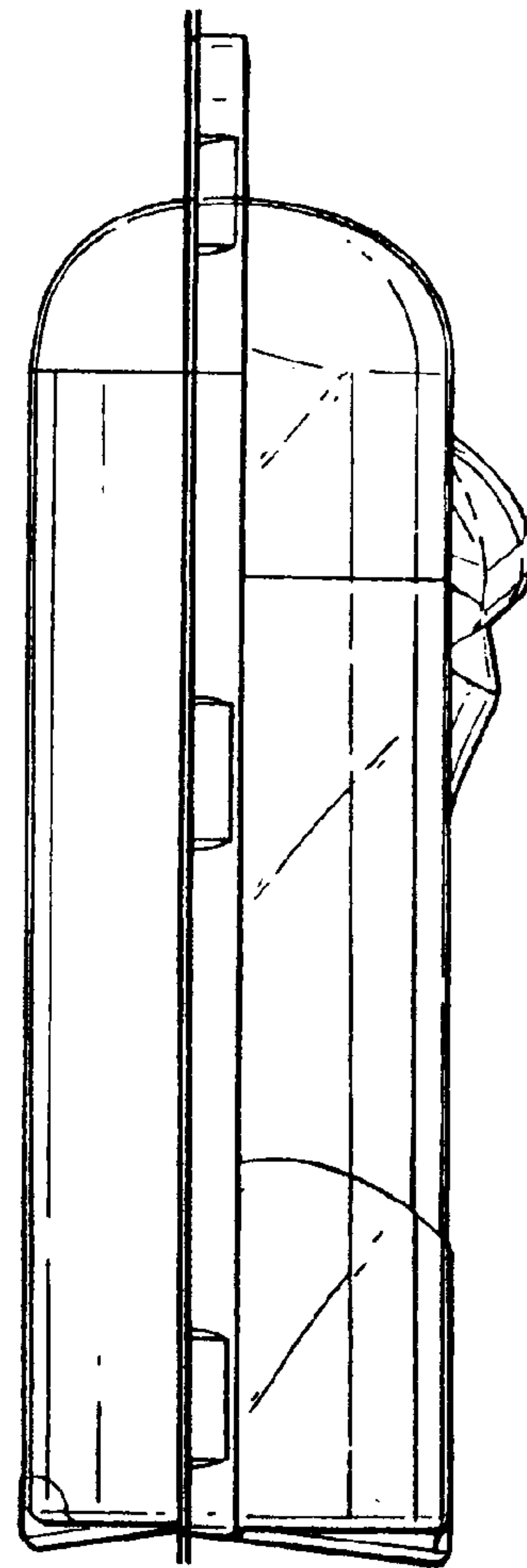

Fig. 5

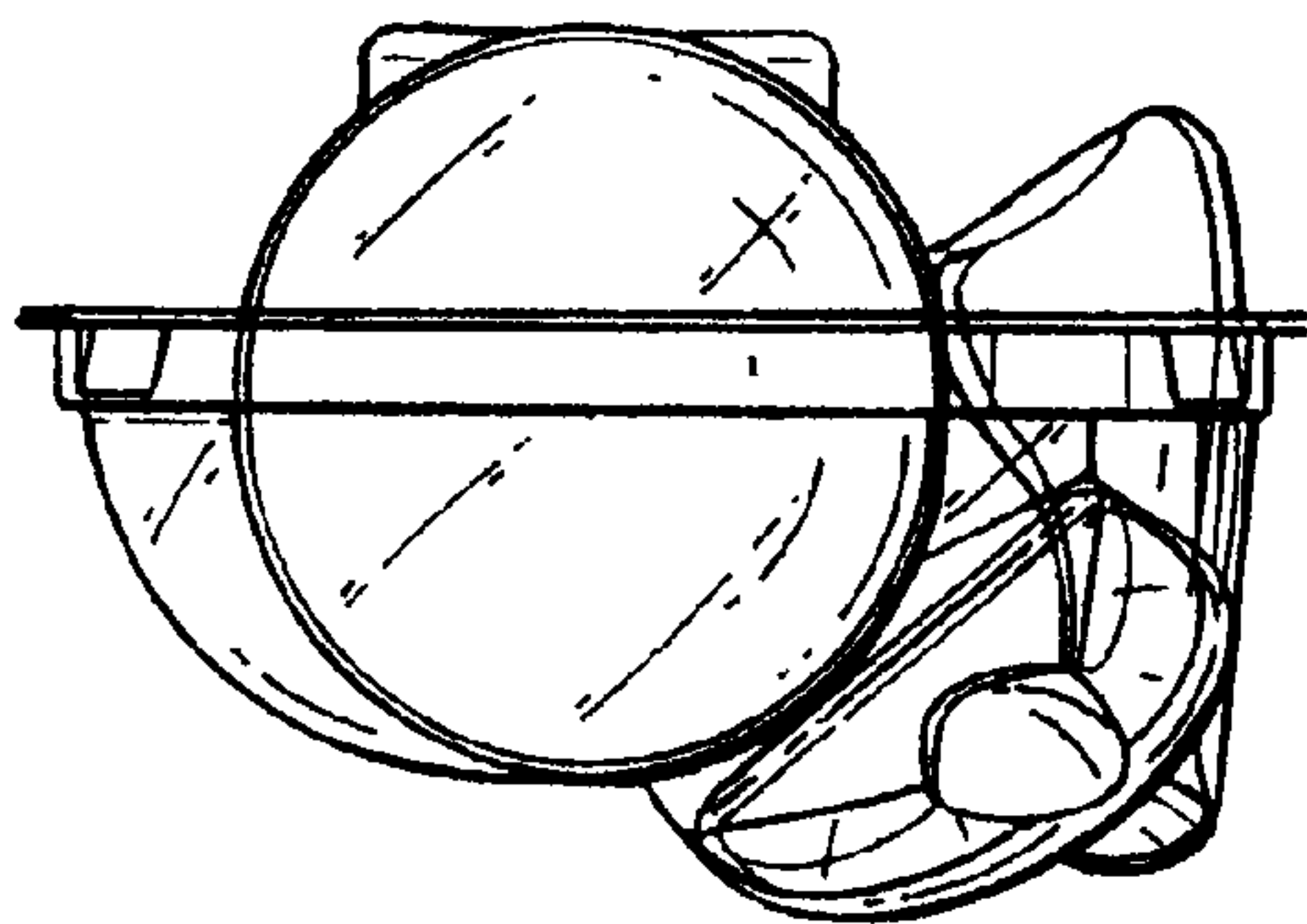

Fig. 6

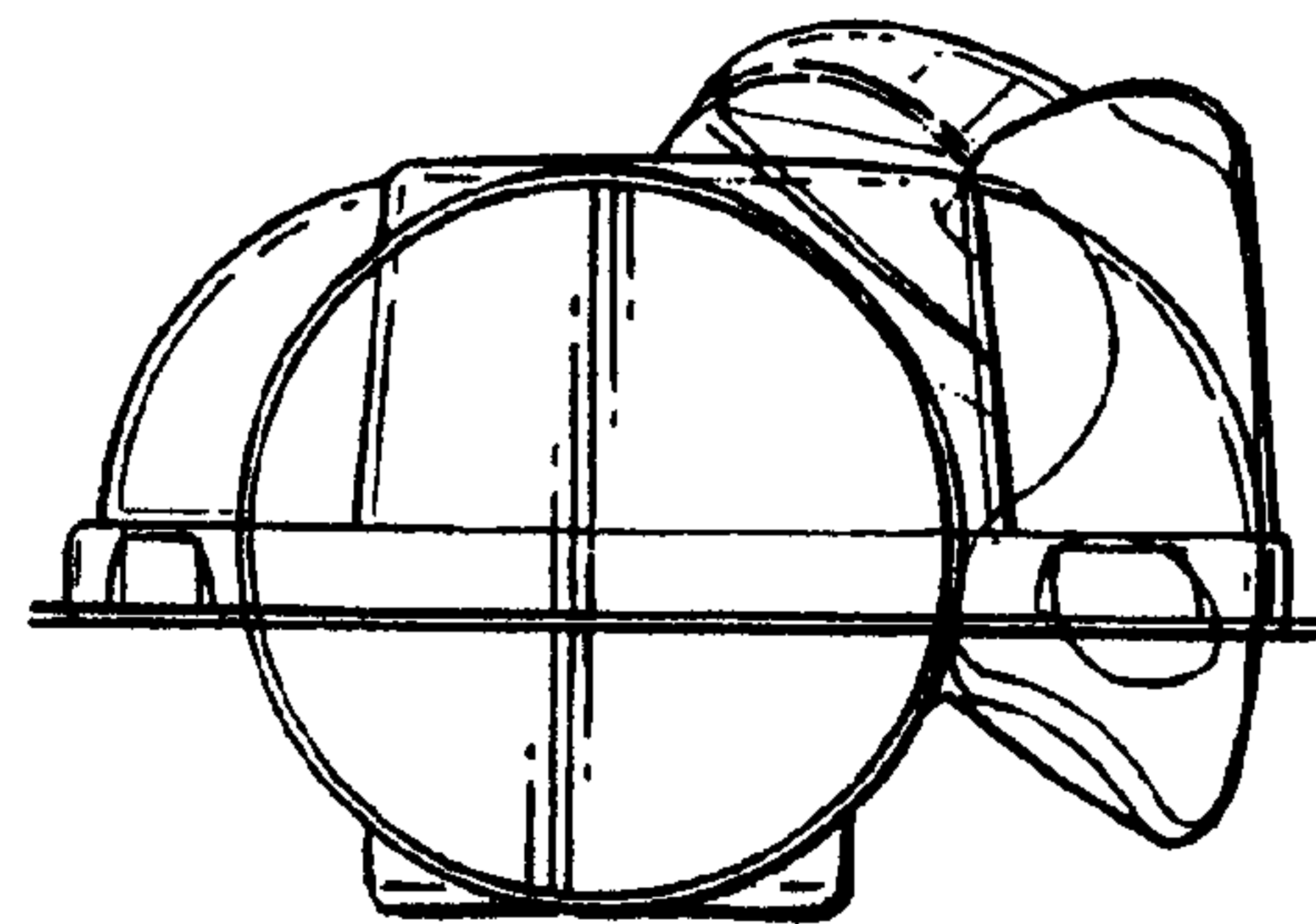

Fig. 7