



US00D522356S

(12) **United States Design Patent**
Liebe

(10) **Patent No.:** **US D522,356 S**
(45) **Date of Patent:** **** Jun. 6, 2006**

- (54) **SLIDE LID CONTAINER**
- (75) Inventor: **Thomas Liebe**, Thun (CH)
- (73) Assignee: **Hoffmann Neopac AG**, Thun (CH)
- (**) Term: **14 Years**
- (21) Appl. No.: **29/234,675**
- (22) Filed: **Jul. 21, 2005**
- (51) **LOC (8) Cl.** **09-03**
- (52) **U.S. Cl.** **D9/426**
- (58) **Field of Classification Search** D9/426,
D9/420, 423, 428; D3/20, 203; 220/345.1,
220/345.2; 206/540, 562, 776
See application file for complete search history.

- D479,462 S 9/2003 Chan D9/422
- 6,637,437 B1 10/2003 Hungerford et al. 128/898
- D484,409 S * 12/2003 Haggerty et al. D9/432
- D485,749 S 1/2004 Zaksenberg et al. D9/338
- D498,139 S 11/2004 Haggerty et al. D9/417
- D507,968 S 8/2005 Dixon et al. D9/422
- D508,312 S * 8/2005 Roche et al. D3/203.2

* cited by examiner

Primary Examiner—Stella Reid
Assistant Examiner—Derrick Holland
(74) *Attorney, Agent, or Firm*—Gifford, Krass, Groh,
Sprinkle, Anderson & Citkowski, P.C.

(57) **CLAIM**

The ornamental design for a slide lid container, as shown and described.

DESCRIPTION

FIG. 1 is a perspective view of a slide lid container, showing my new design;
FIG. 2 is a perspective view thereof, in an open position;
FIG. 3 is a top plan view thereof;
FIG. 4 is a left view thereof;
FIG. 5 is a front view thereof, in a closed position;
FIG. 6 is a front view thereof, in an open position; and,
FIG. 7 is a bottom plan view thereof.

1 Claim, 2 Drawing Sheets

(56) **References Cited**

U.S. PATENT DOCUMENTS

- 1,988,134 A 1/1935 Nitardy 206/42
- 2,295,747 A * 9/1942 Mills 220/351
- D199,819 S 12/1964 Palson D58/12
- D341,778 S 11/1993 D'Amico et al. D9/417
- 5,878,887 A 3/1999 Parker et al. 206/528
- D407,972 S 4/1999 Hilton D9/422
- D446,718 S * 8/2001 Anderson D9/422
- D465,729 S 11/2002 Nishimura D9/422

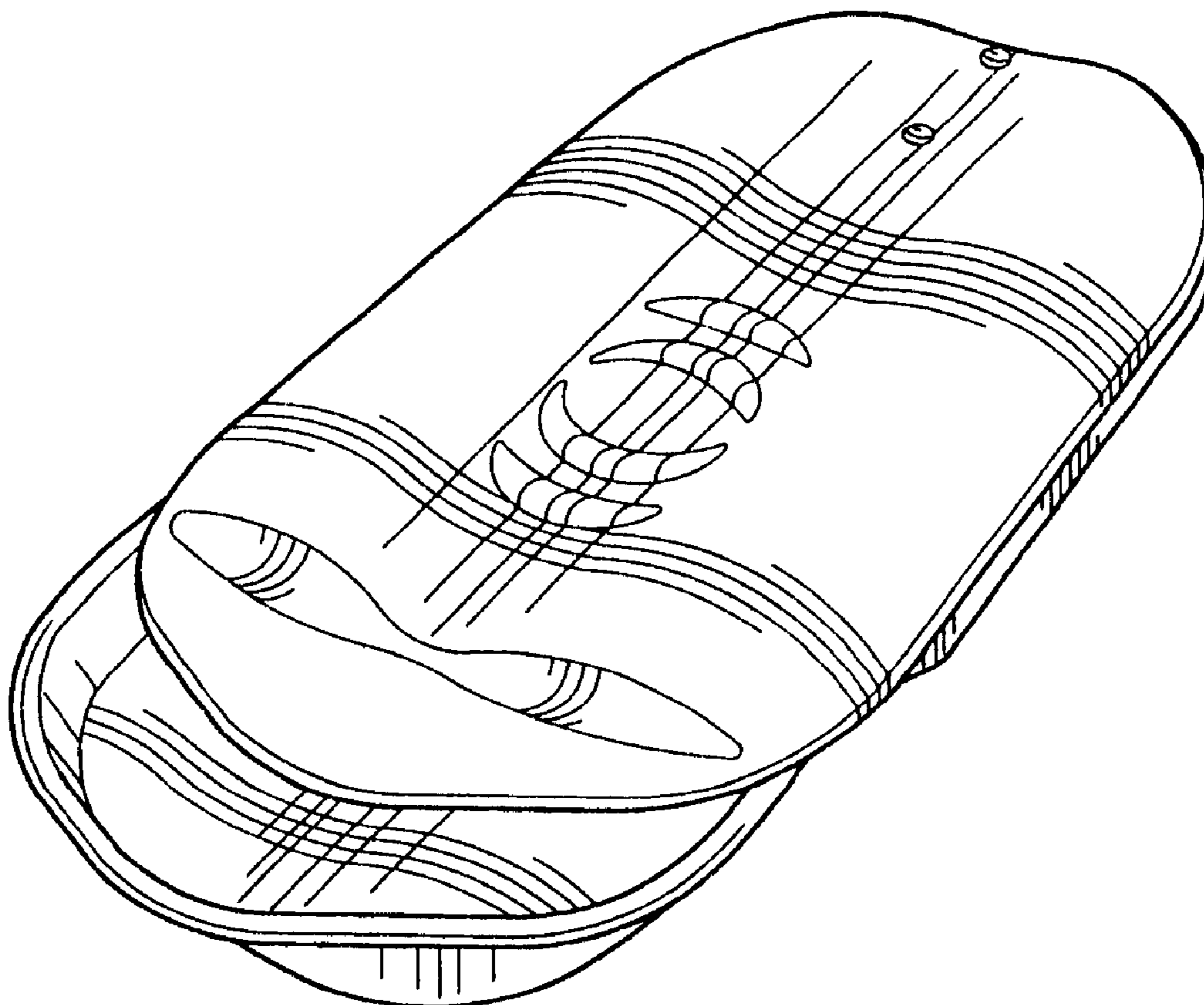

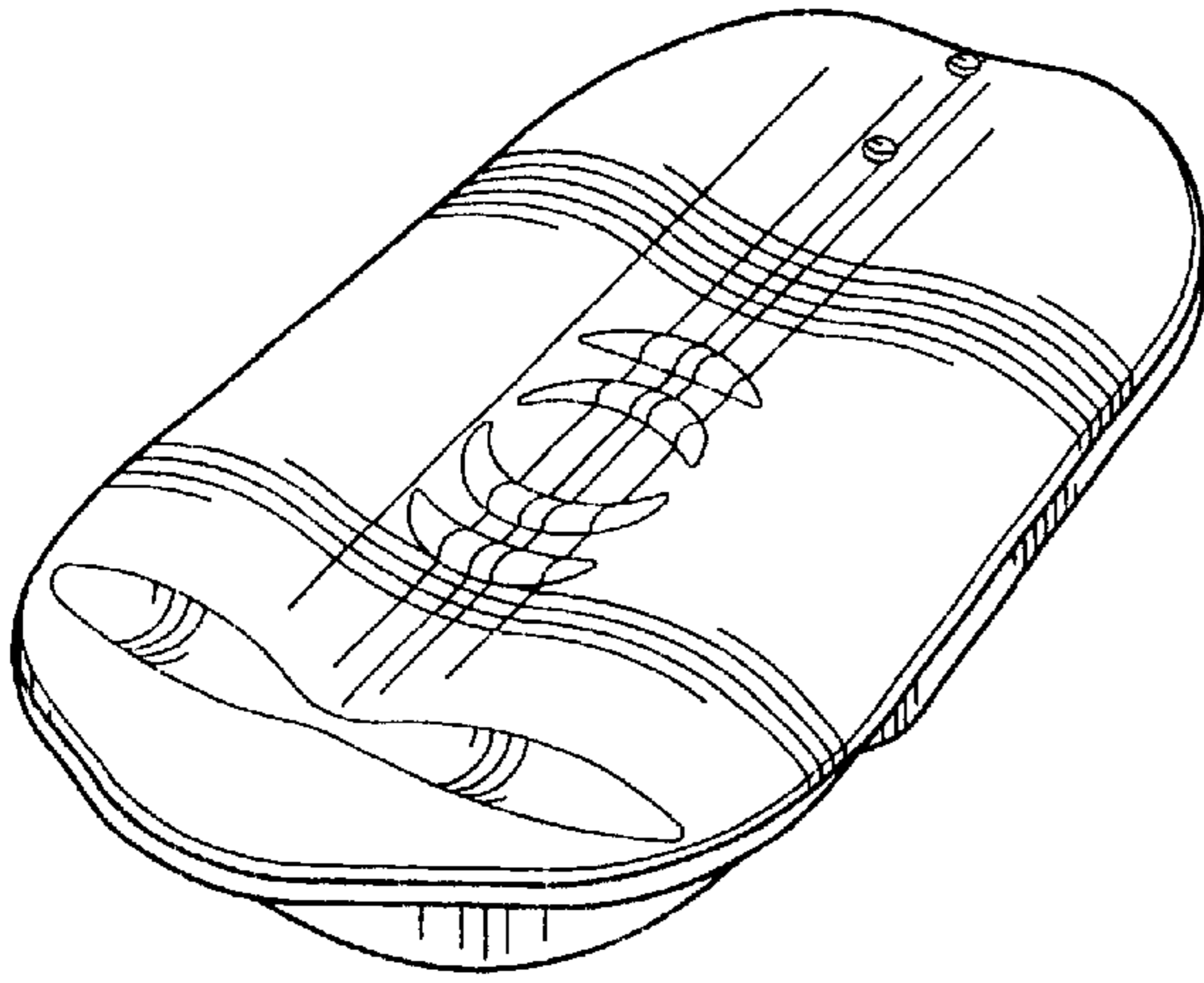

Figure 1

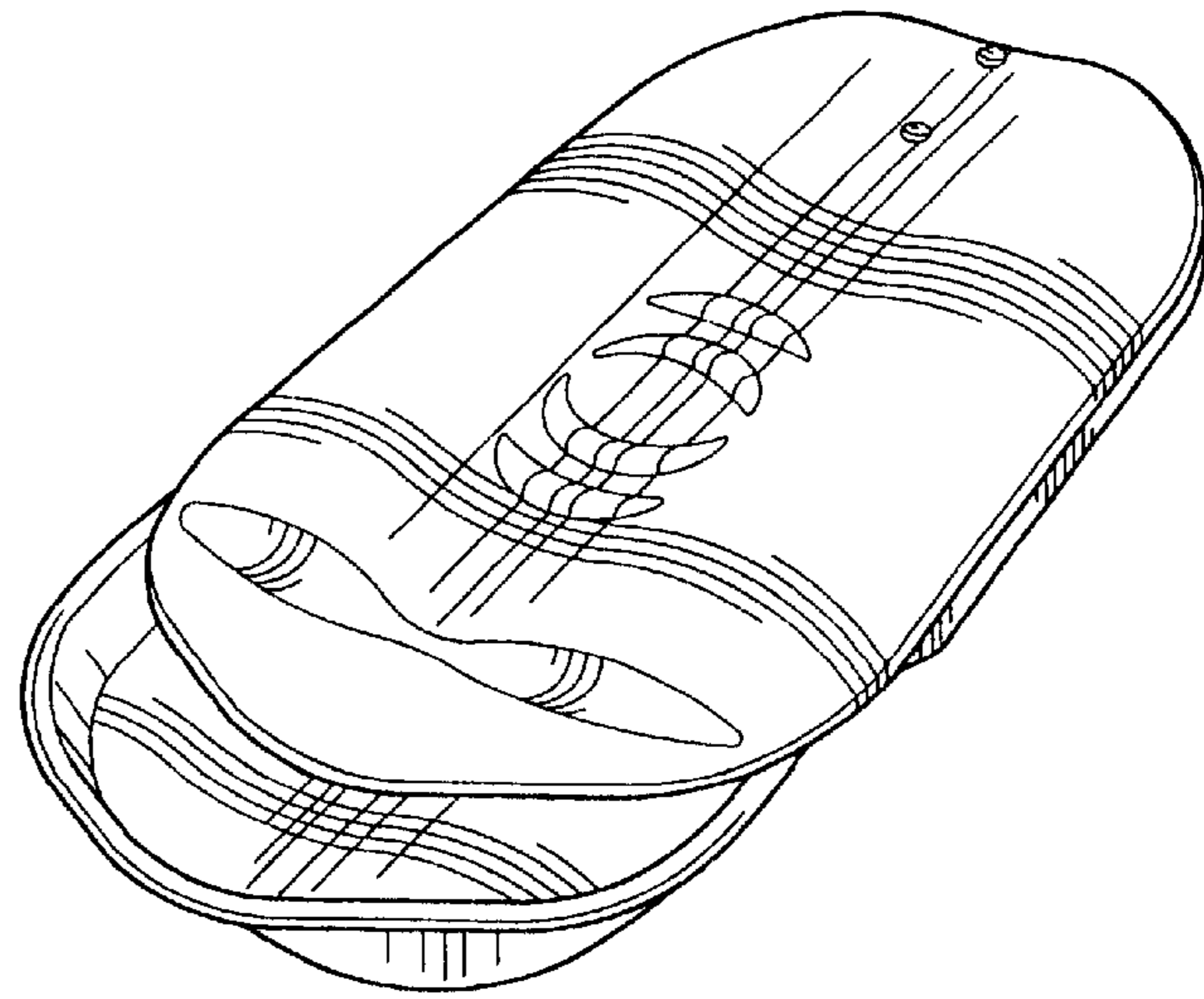

Figure 2

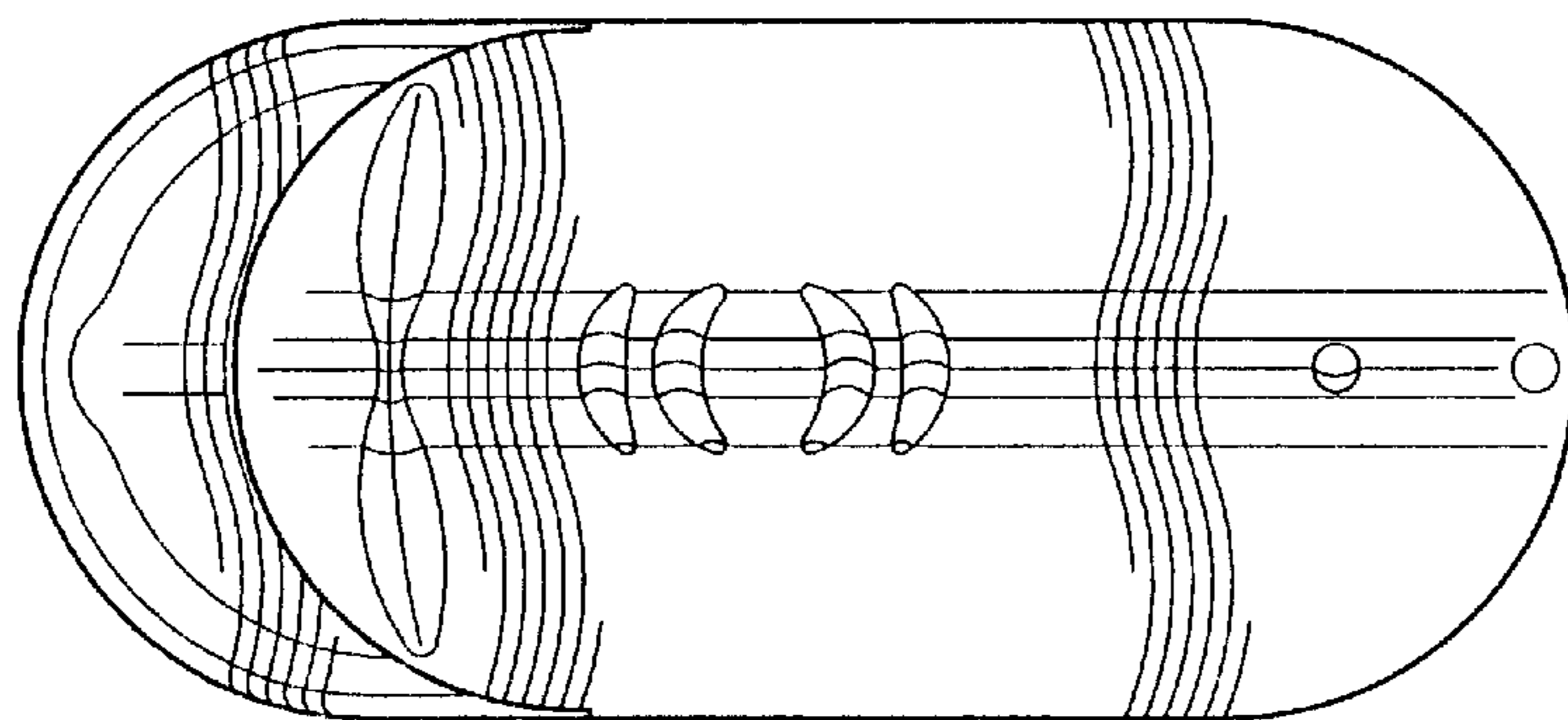

Figure 3

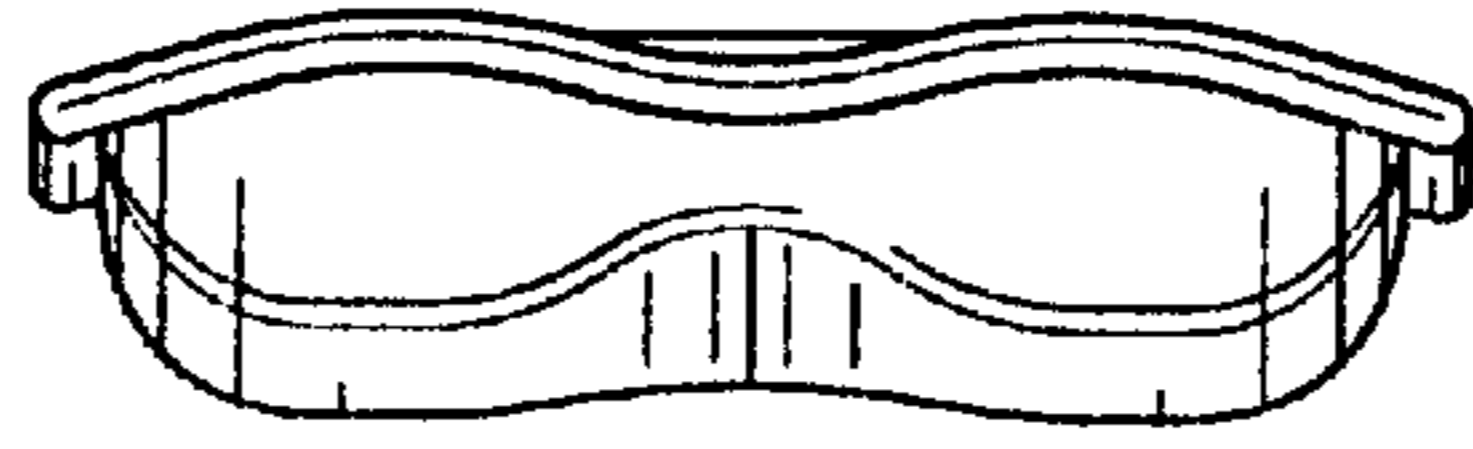

Figure 4

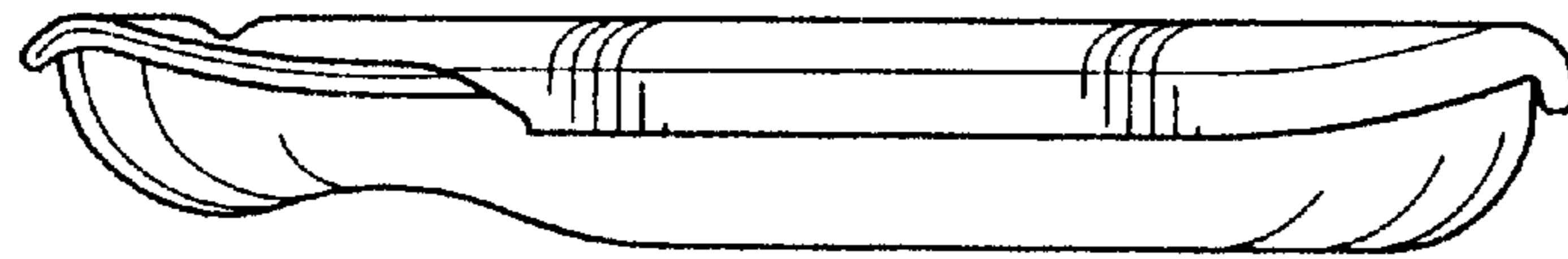

Figure 5

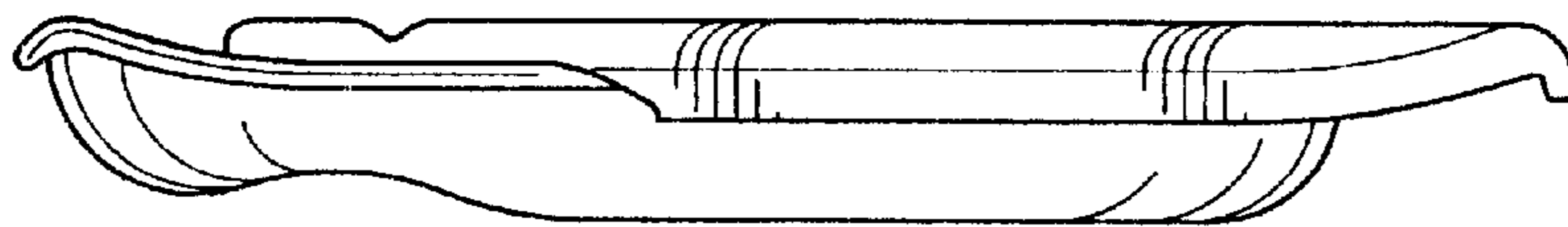

Figure 6

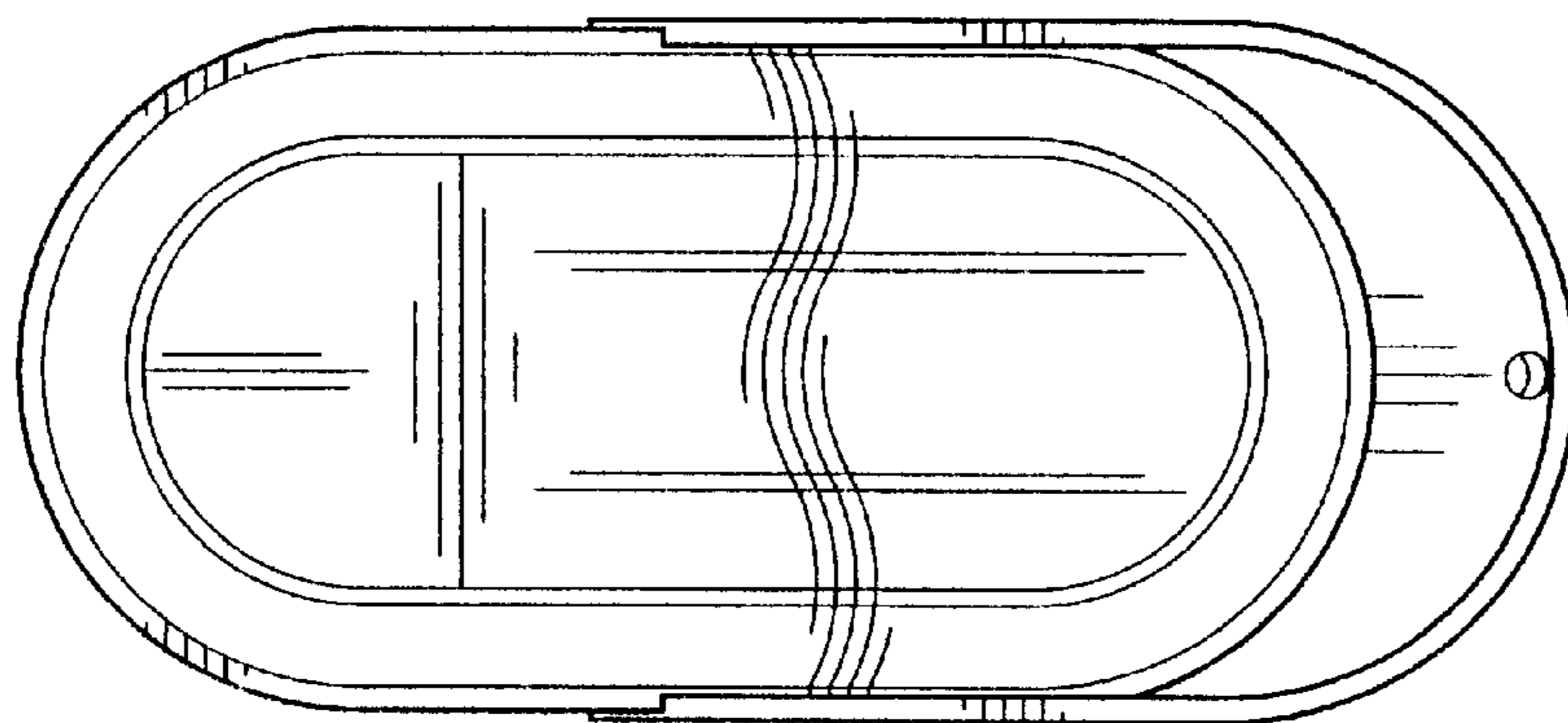

Figure 7