



US00D522265S

(12) **United States Design Patent**
Glass et al.

(10) **Patent No.:** **US D522,265 S**
(45) **Date of Patent:** **** Jun. 6, 2006**

(54) **CHAIR**

(75) Inventors: **Peter Glass**, Arroyo Grande, CA (US);
Robert J. Mills, Torrance, CA (US)

(73) Assignee: **Virco Mgmt. Corporation**, Torrance,
CA (US)

(**) Term: **14 Years**

(21) Appl. No.: **29/231,656**

(22) Filed: **Jun. 7, 2005**

(51) **LOC (8) Cl.** **06-01**

(52) **U.S. Cl.** **D6/375**

(58) **Field of Classification Search** D6/334–336,
D6/338, 360, 365, 366, 371–373, 471, 374,
D6/375, 376, 379, 380, 500–502; 297/DIG. 2,
297/445.1, 446.1, 447.2, 448.1, 452.1
See application file for complete search history.

(56) **References Cited**

U.S. PATENT DOCUMENTS

- D169,930 S * 6/1953 Chapman et al. D6/374
- D174,927 S * 6/1955 Shannon D6/375
- 2,745,468 A * 5/1956 Kramer 297/DIG. 2
- D189,347 S * 11/1960 Chapman et al. D6/375
- D197,643 S * 3/1964 Kramer D6/366

(Continued)

OTHER PUBLICATIONS

2 Photos of Artco–Bell Chairs, Jan. 2005.
Internet advertisement for desk and chair combination, publication date unknown, but at least as early as Jun. 14, 2005. From Artco–Bell Web site, date unknown, but at least as early as Jun. 20, 2005.
Internet Advertisement: New Product Introductions, NeoCon, Chicago, 2005.
Internet Advertisement: Trica Stools, publication date unknown.
Internet Advertisement: Chair–One Booho, publication date unknown.

Internet Advertisement: Korea Federation of Furniture Industry Cooperatives, publication date unknown.

Internet Advertisement: NeoCon World’s Trade Fair 2005, Jun. 13–15, 2005.

Internet Advertisement: NeoCon World’s Trade Fair Interior Design Show Daily, publication date unknown.

Internet Advertisement: ERG International—Office and Contract Furniture, publication date unknown.

Internet Advertisement: Versteel—Chela, publication date unknown.

Internet Advertisement: Allermuir—Furniture Manufacturers, publication date unknown.

Internet Advertisement: HermanMiller for Business, publication date unknown.

Internet Advertisement: Bernhardt Design, publication date unknown.

Internet Advertisement: Gauss–Chair.com, publication date unknown.

Internet Advertisement: TMC The Midlands Company, publication date unknown.

Internet Advertisement: Steelmobil—Prodotti, publication date unknown.

Primary Examiner—Mimosa De

(74) *Attorney, Agent, or Firm*—Denton L. Anderson; Sheldon & Mak; Robert M. Hupe

(57) **CLAIM**

The ornamental design for a chair, as shown and described.

DESCRIPTION

FIG. 1 is a perspective view of the chair of the invention; FIG. 2 is a front view of the chair illustrated in FIG. 1; FIG. 3 is a left side view and the mirror image of the right side view of the chair illustrated in FIG. 1; FIG. 4 is a top view of the chair illustrated in FIG. 1; FIG. 5 is a bottom view of the chair illustrated in FIG. 1; and, FIG. 6 is a rear view of the chair illustrated in FIG. 1. The broken lines shown in the drawing are for illustrative purposes only and form no part of the claimed design.

1 Claim, 4 Drawing Sheets

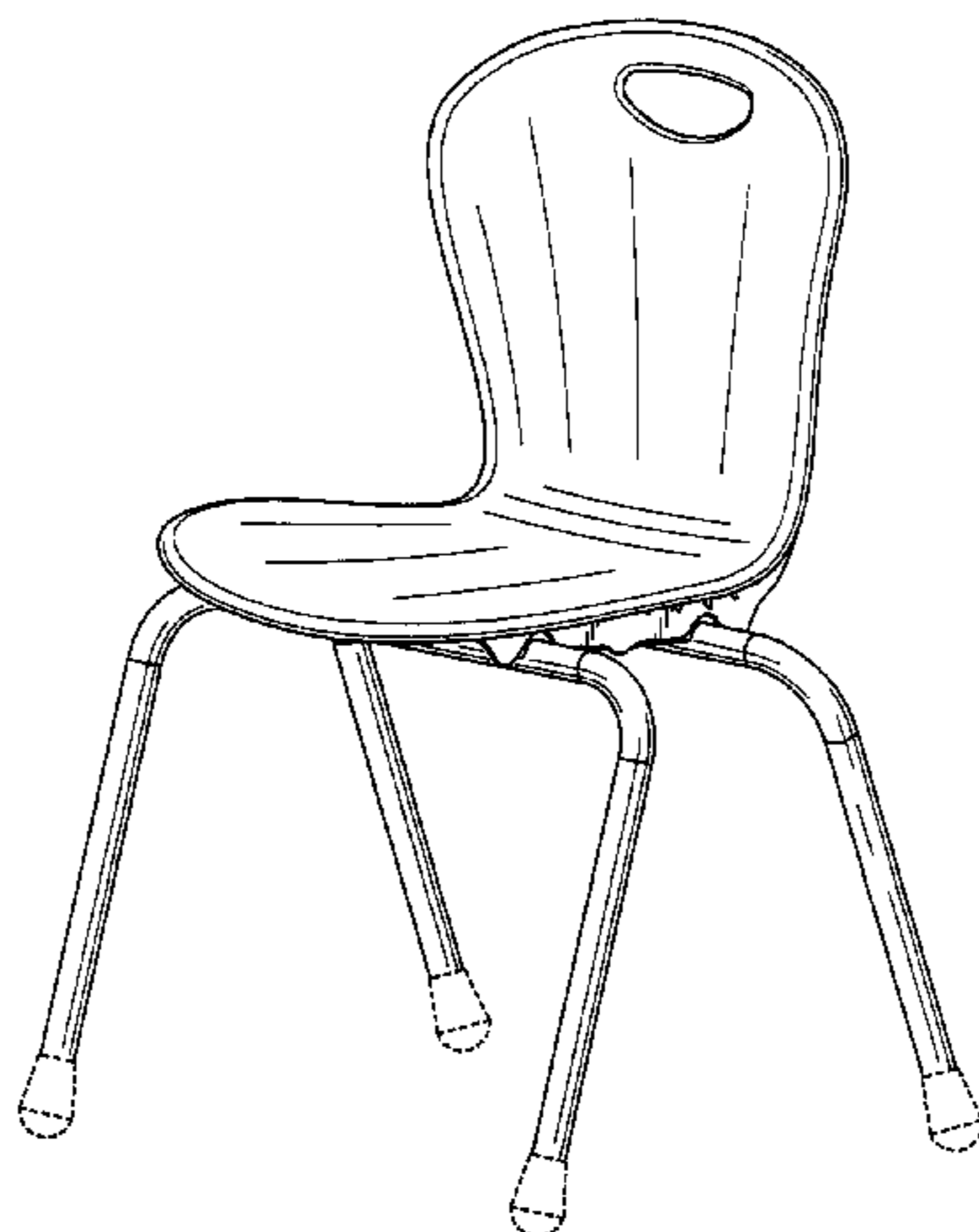

US D522,265 S

Page 2

U.S. PATENT DOCUMENTS

D202,549 S	*	10/1965	Kramer	D6/375	D471,729 S	*	3/2003	Glass et al.	D6/375
D202,550 S	*	10/1965	Kramer	D6/375	D471,730 S		3/2003	Schloss		
3,276,818 A	*	10/1966	Durfee et al.	297/448.1	D499,260 S		12/2004	Glass et al.		
3,669,496 A	*	6/1972	Chisholm	297/448.1	D503,559 S	*	4/2005	Glass et al.	D6/372
4,002,369 A		1/1977	Jennings			D504,026 S	*	4/2005	Glass et al.	D6/366
D360,083 S	*	7/1995	Lohmeyer	D6/375	D505,022 S	*	5/2005	Mills et al.	D6/338
D388,629 S	*	1/1998	Piretti	D6/380	D507,890 S	*	8/2005	Mills et al.	D6/336
D470,320 S		2/2003	Schloss			D507,893 S	*	8/2005	Glass et al.	D6/360

* cited by examiner

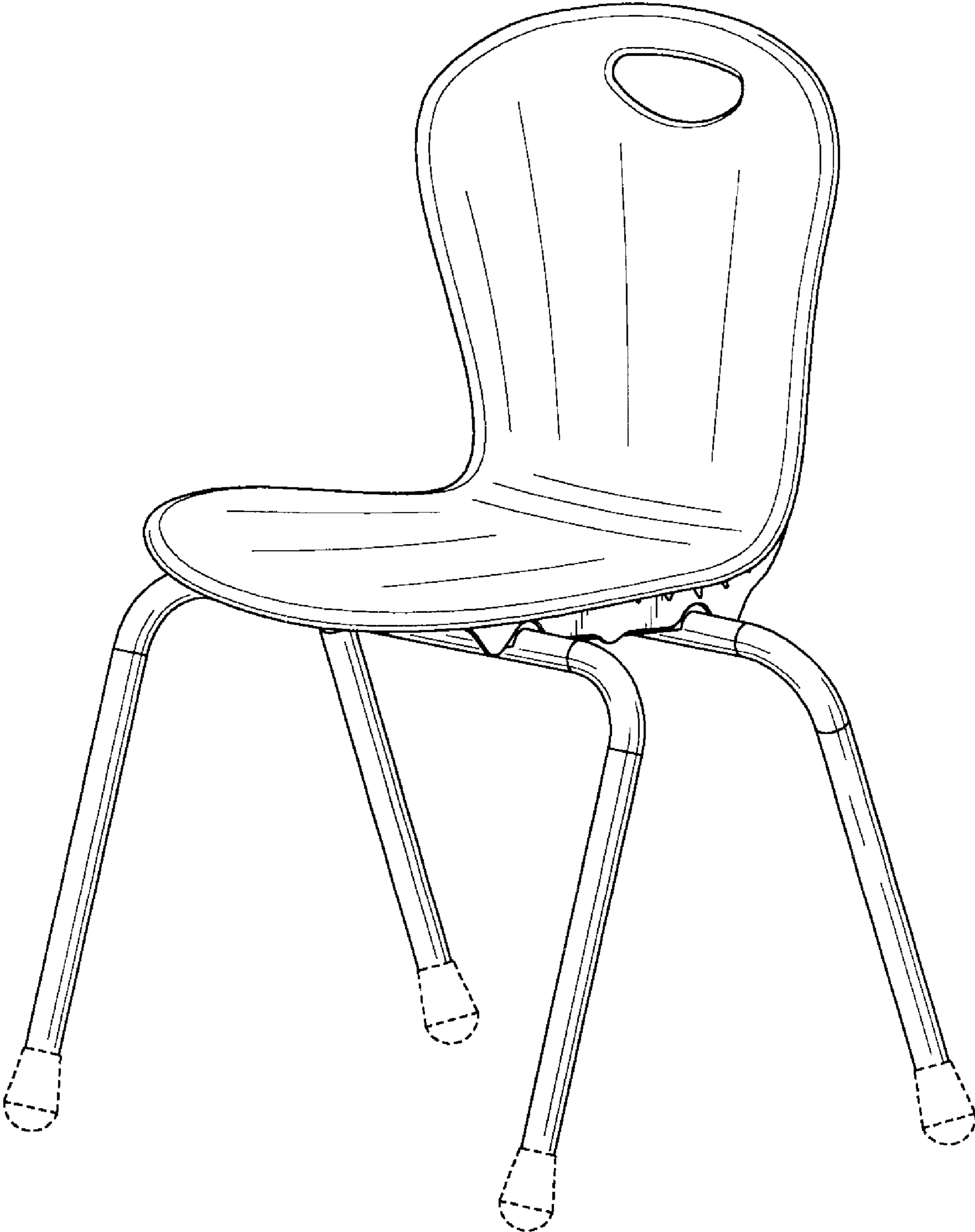

FIG. 1

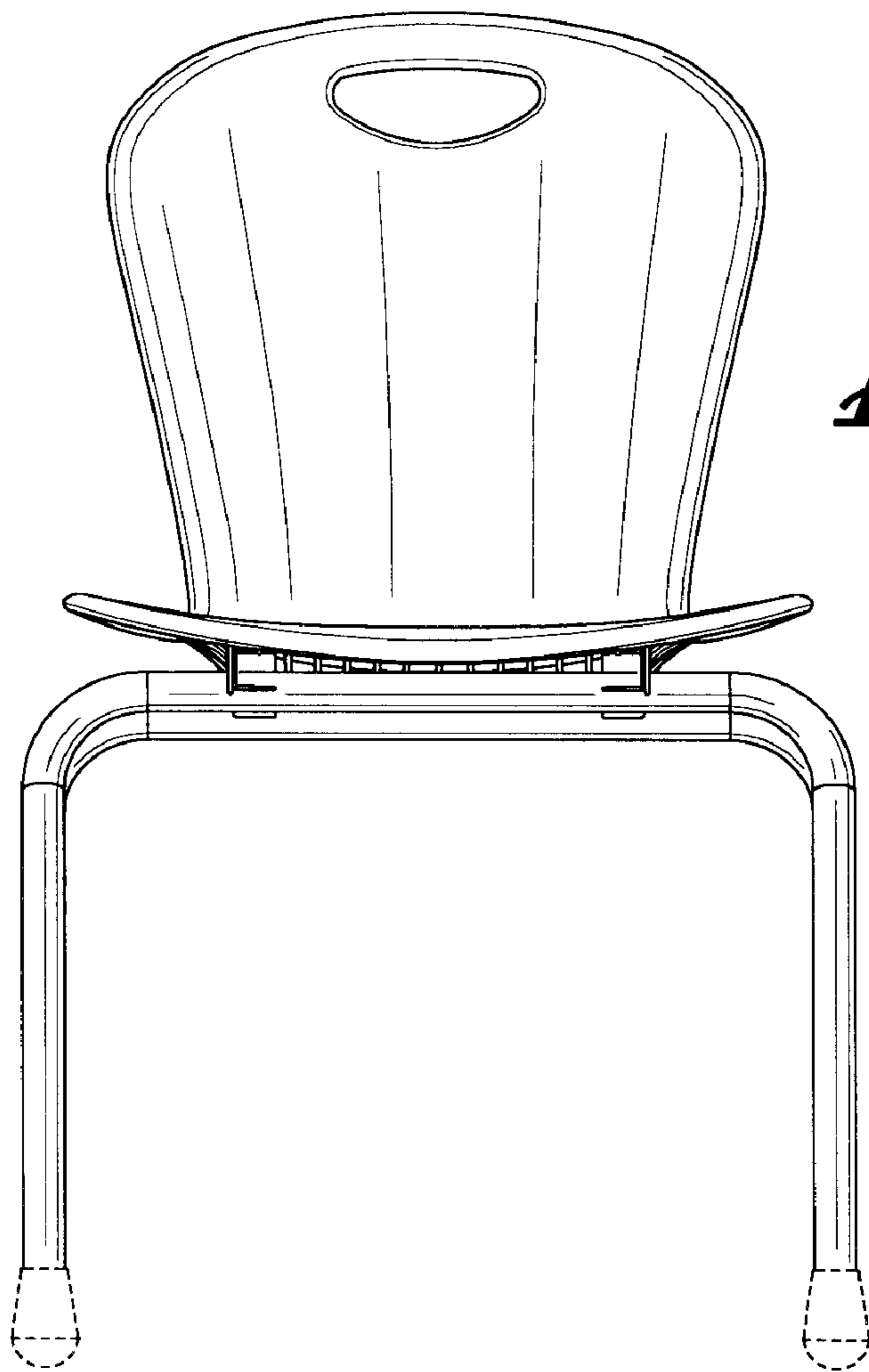

FIG. 2

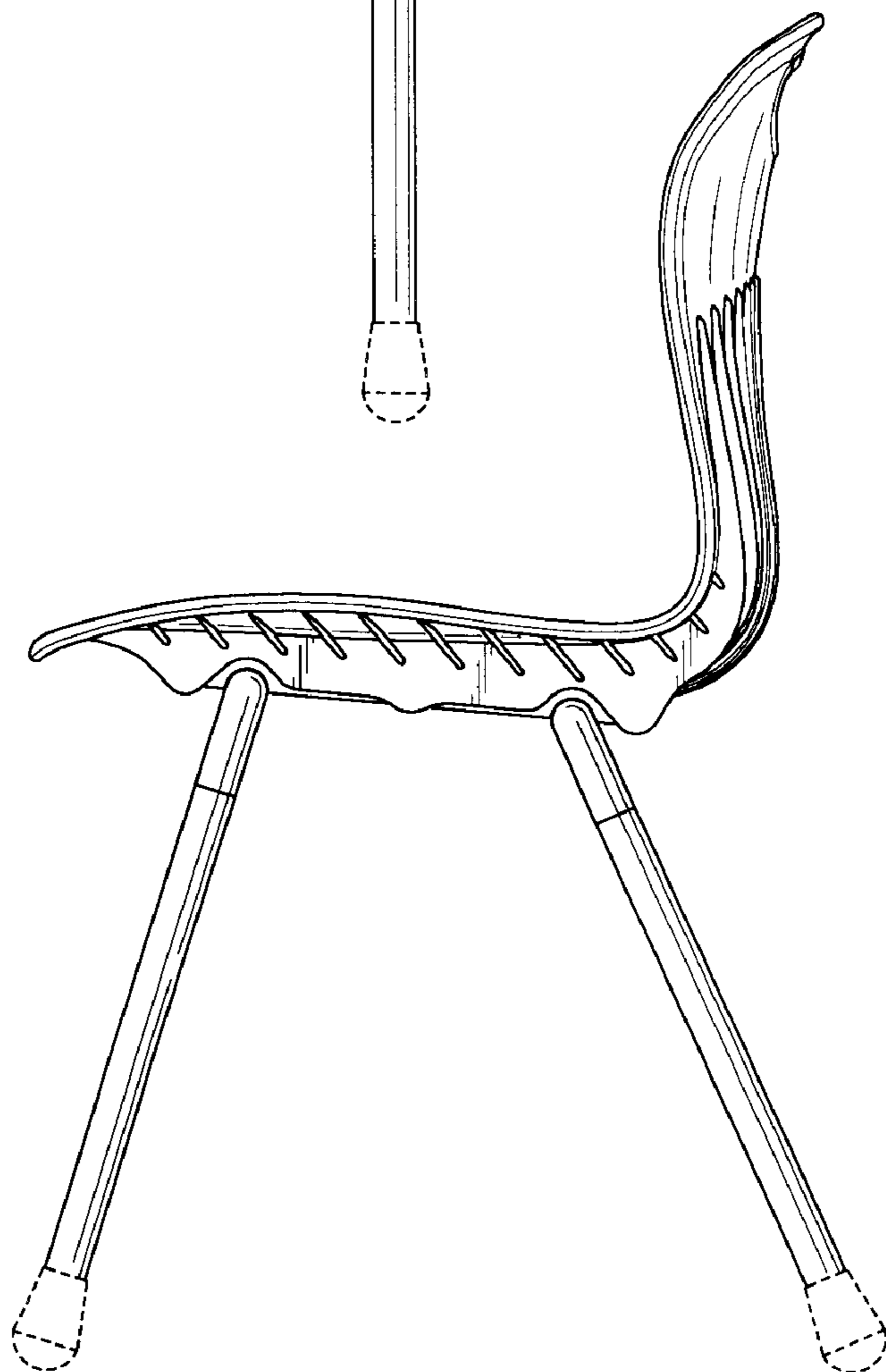

FIG. 3

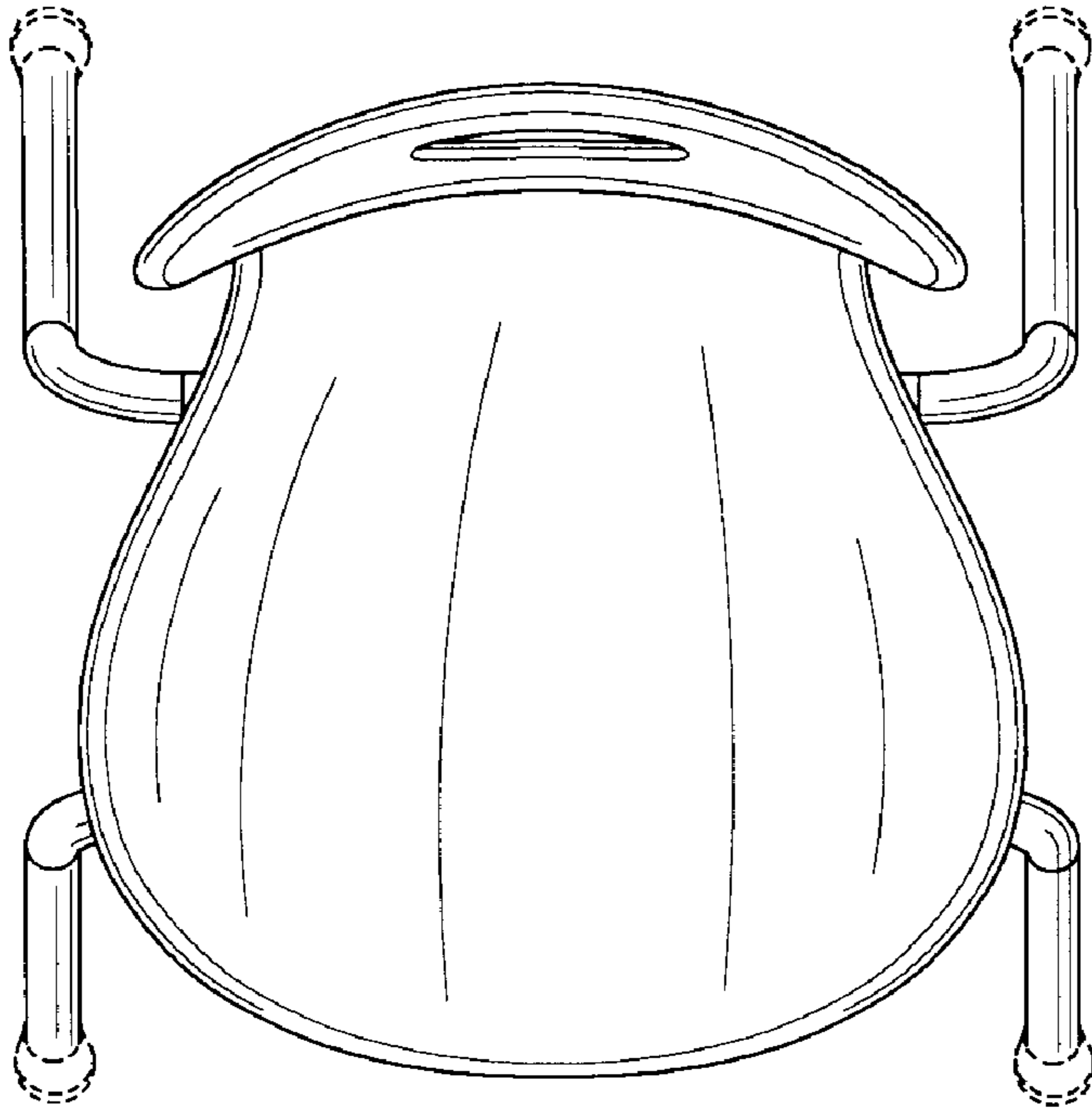

FIG. 4

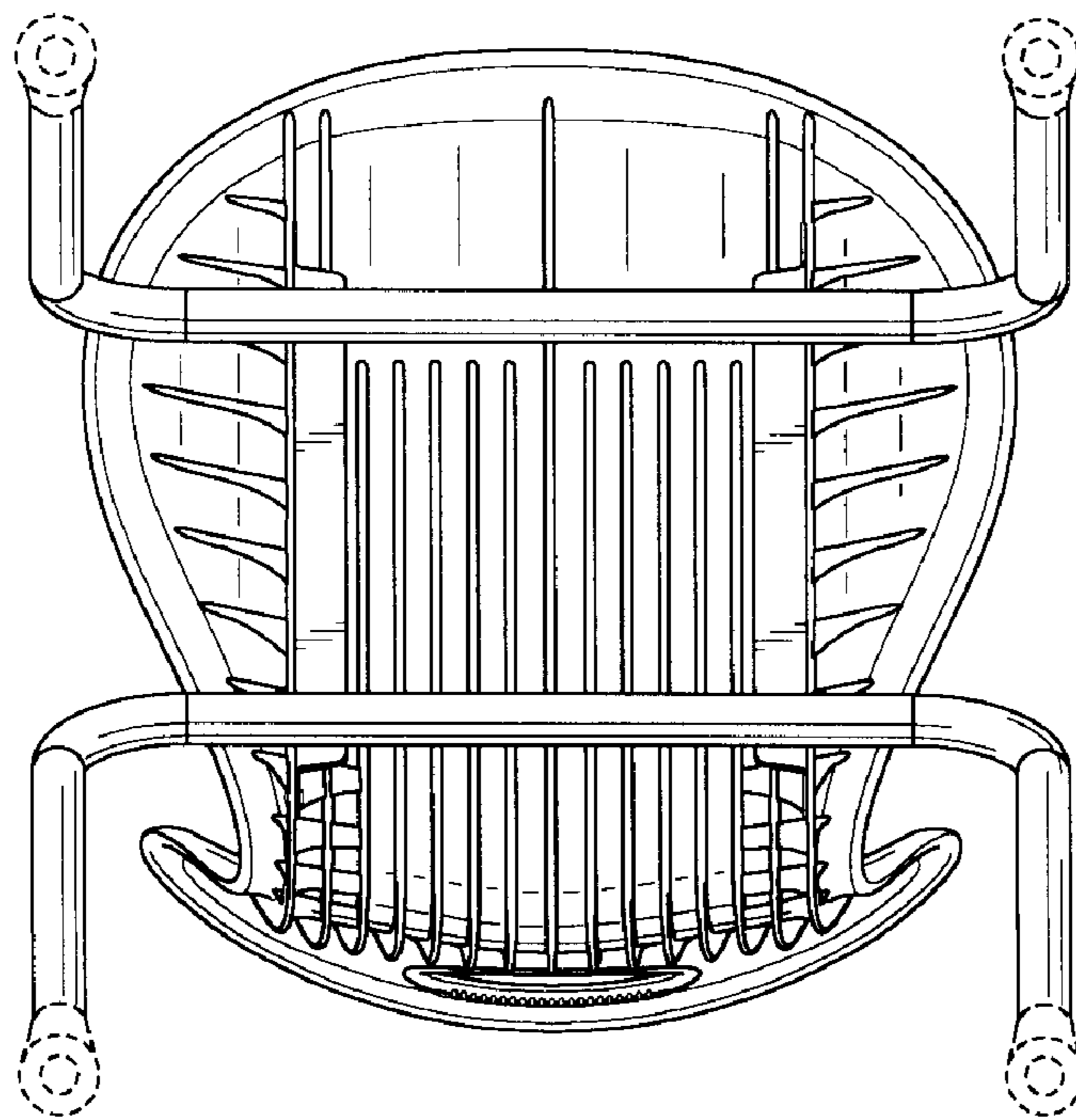

FIG. 5

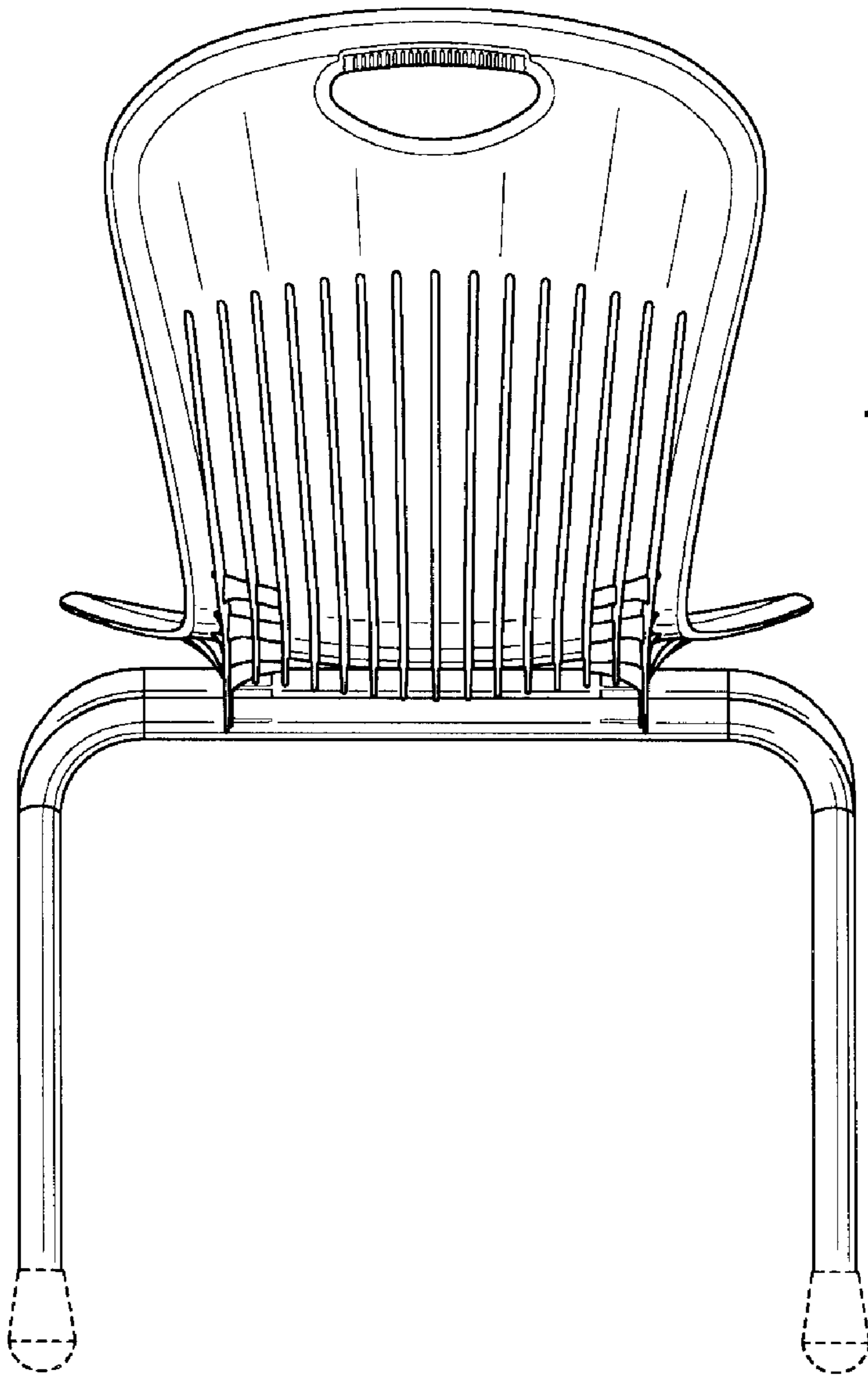

FIG. 6