

US00D522166S

(12) **United States Design Patent**
Herst et al.

(10) **Patent No.:** **US D522,166 S**

(45) **Date of Patent:** **** May 30, 2006**

(54) **PORTION OF A LIGHTING FIXTURE**

D480,501 S 10/2003 Herst et al.
D480,502 S 10/2003 Herst et al.
D480,503 S 10/2003 Herst et al.
D481,488 S 10/2003 Herst et al.

(75) Inventors: **Douglas J. Herst**, Ross, CA (US);
Michael Trung Tran, Oakland, CA
(US)

OTHER PUBLICATIONS

(73) Assignee: **Acuity Brands, Inc.**, Atlanta, GA (US)

Peerless Lighting, Product Announcement, "Introducing Cerra Full Baffle," Apr. 19, 2 pages, Apr. 19, 2002.

(**) Term: **14 Years**

* cited by examiner

(21) Appl. No.: **29/202,455**

Primary Examiner—Clare E Heflin

(22) Filed: **Mar. 31, 2004**

(74) *Attorney, Agent, or Firm*—Donald L. Beeson

(51) **LOC (8) Cl.** **26-99**

(57) **CLAIM**

(52) **U.S. Cl.** **D26/121; D26/77**

The ornamental design for a portion of a lighting fixture, as shown and described.

(58) **Field of Classification Search** D26/72,
D26/75–78, 118, 119, 121, 122, 152; 362/605,
362/147, 151, 217–225, 256, 260, 291, 342,
362/354

DESCRIPTION

See application file for complete search history.

FIG. 1 is a bottom perspective view of a portion of a lighting fixture showing our new design;
FIG. 2 is another bottom perspective view thereof with the end cap and end shield shown in broken lines removed;
FIG. 3 is bottom plan view thereof;
FIG. 4 is a side elevational view thereof, the other side being a mirror image;
FIG. 5 is a top plan view thereof; and,
FIG. 6 is an enlarged cross-sectional view thereof taken long lines 6—6 in FIG. 4.
FIGS. 1–5 are broken away to indicate indeterminate length. The broken lines shown in FIGS. 1–6 are for illustrative purposes only and form no part of our claimed design. The broken lines in FIG. 5 also represent the bounds of the claimed design; the regions within these broken lines form no part of our claimed design.

(56) **References Cited**

U.S. PATENT DOCUMENTS

D117,643 S	*	11/1939	Stewart	D26/77
D120,544 S	*	5/1940	Carter, Jr.	D26/77
D130,740 S	*	12/1941	Biller	D26/77
D143,641 S	*	1/1946	Biller et al.	D26/121
D147,905 S	*	11/1947	Holmes	D26/86
D156,765 S	*	1/1950	Quin	D26/77
D160,417 S	*	10/1950	Nitardy	D26/77
2,946,880 A	*	7/1960	Picha et al.	362/224
D455,516 S	*	4/2002	Casciani et al.	D26/76
6,402,345 B1	*	6/2002	Fishman	362/291
D480,168 S		9/2003	Herst et al.		
D480,172 S		9/2003	Herst et al.		
D480,500 S		10/2003	Herst et al.		

1 Claim, 4 Drawing Sheets

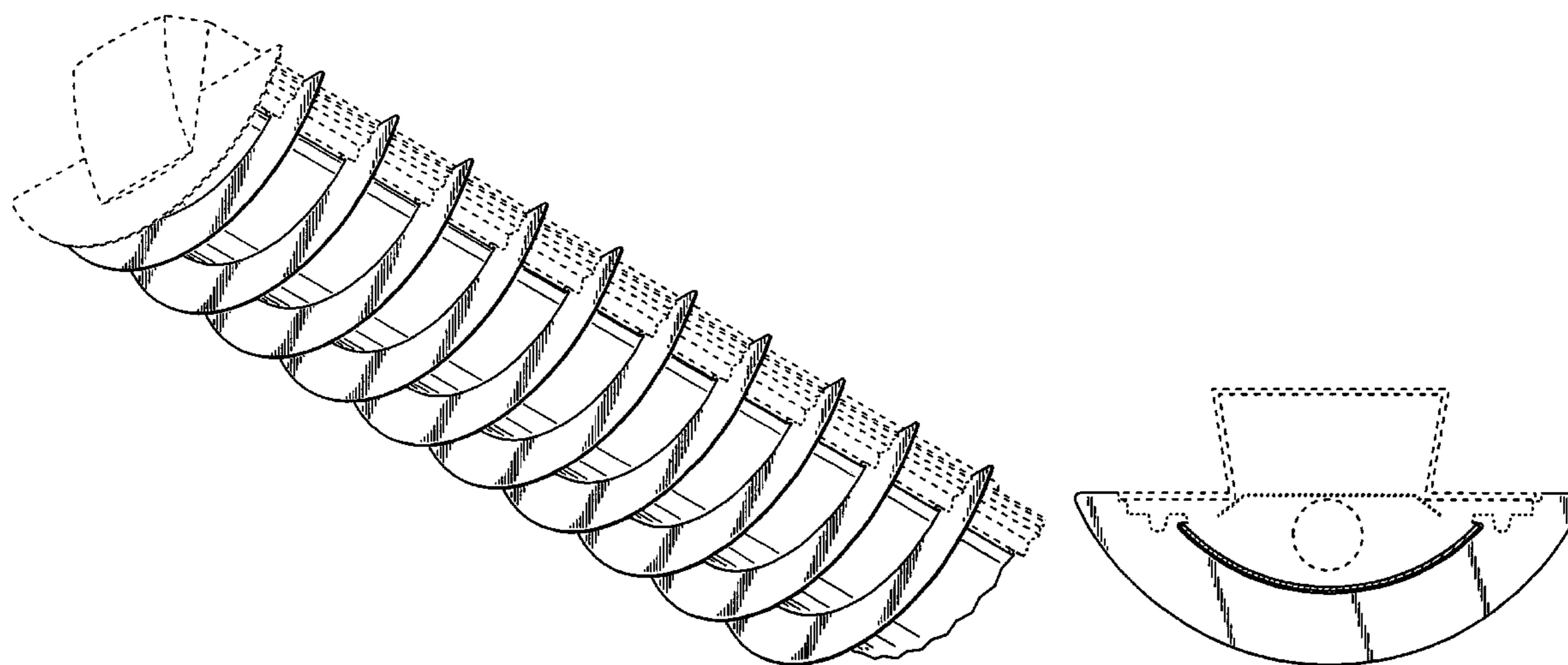

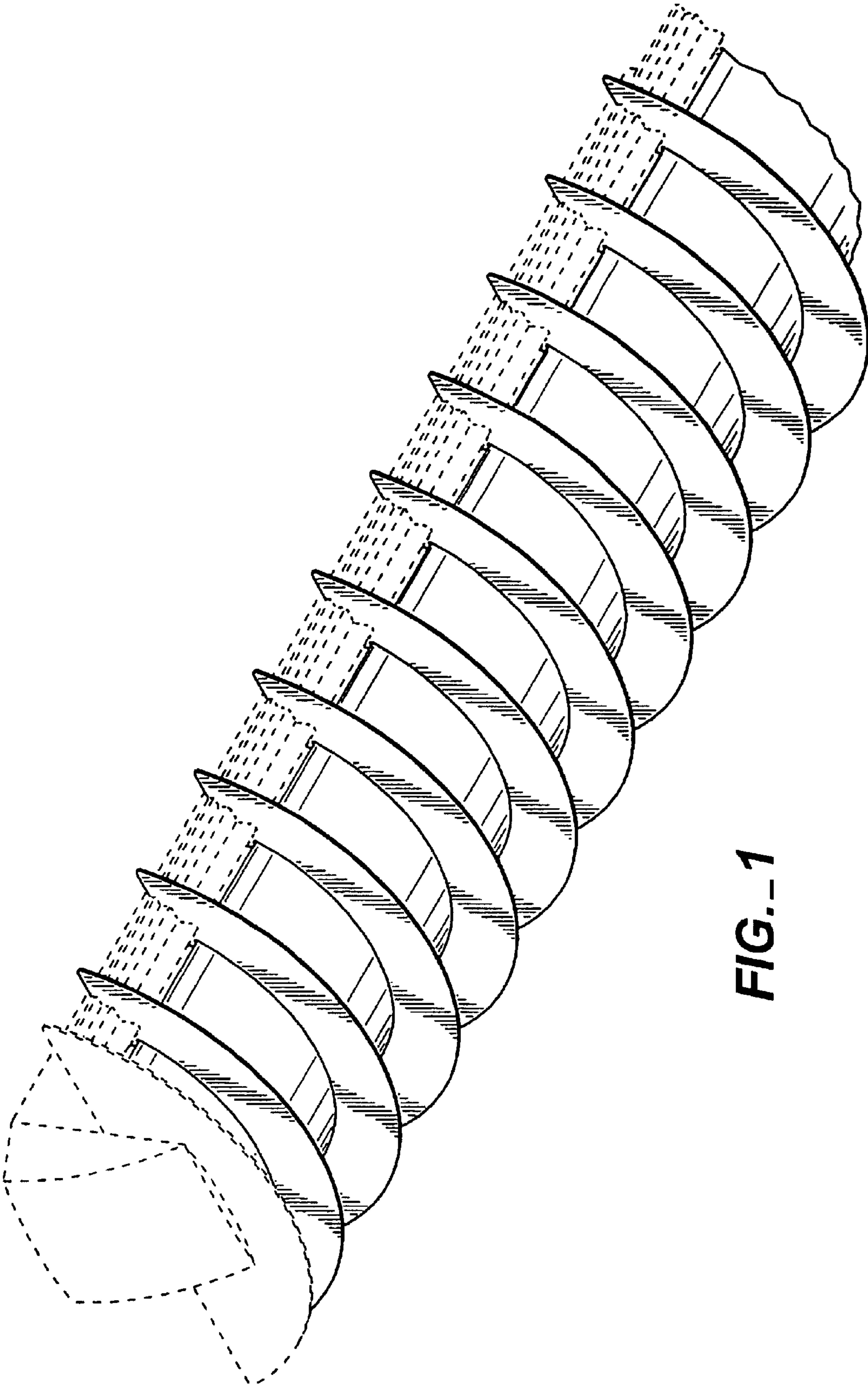

FIG.-1

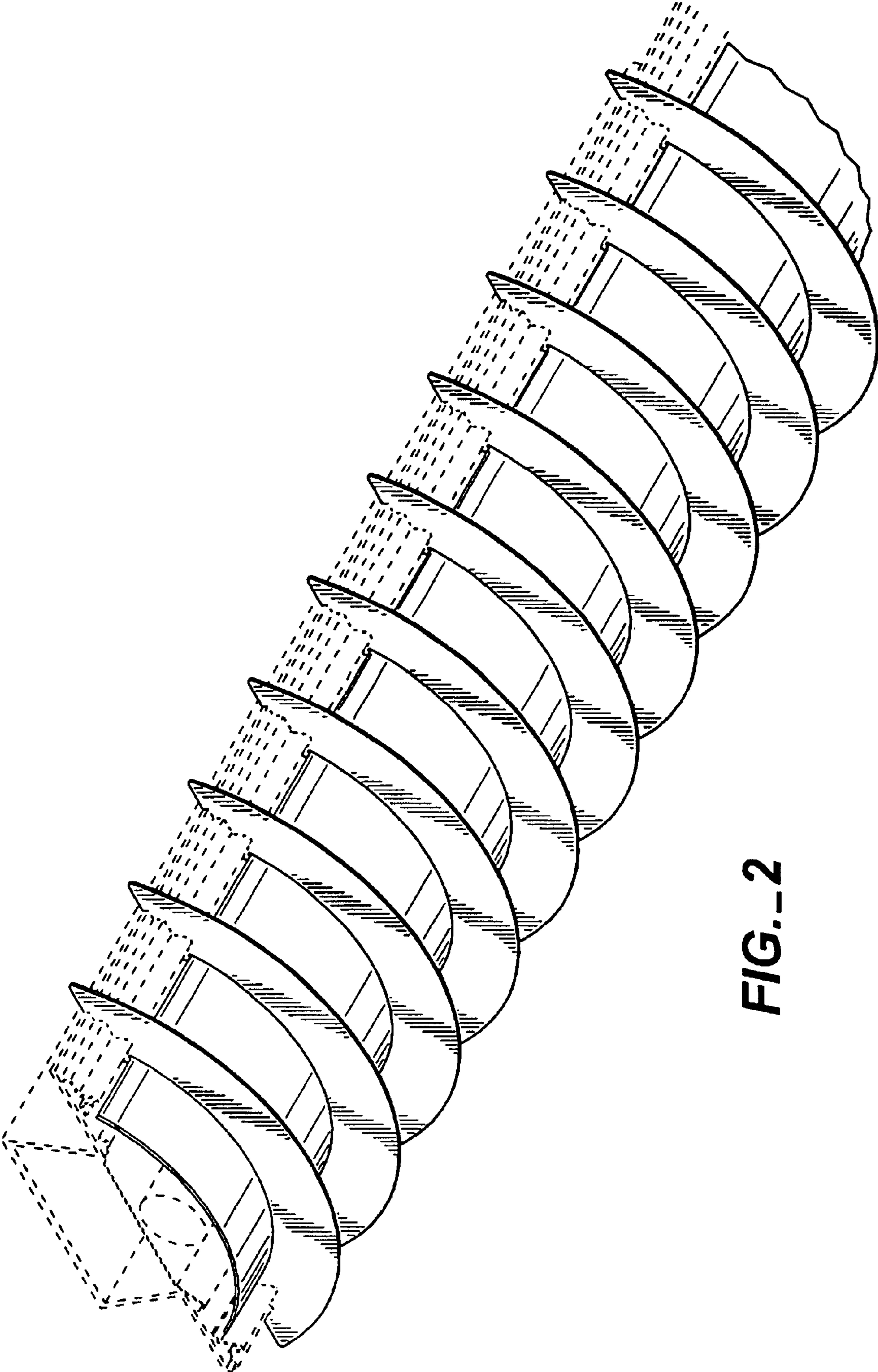

FIG.-2

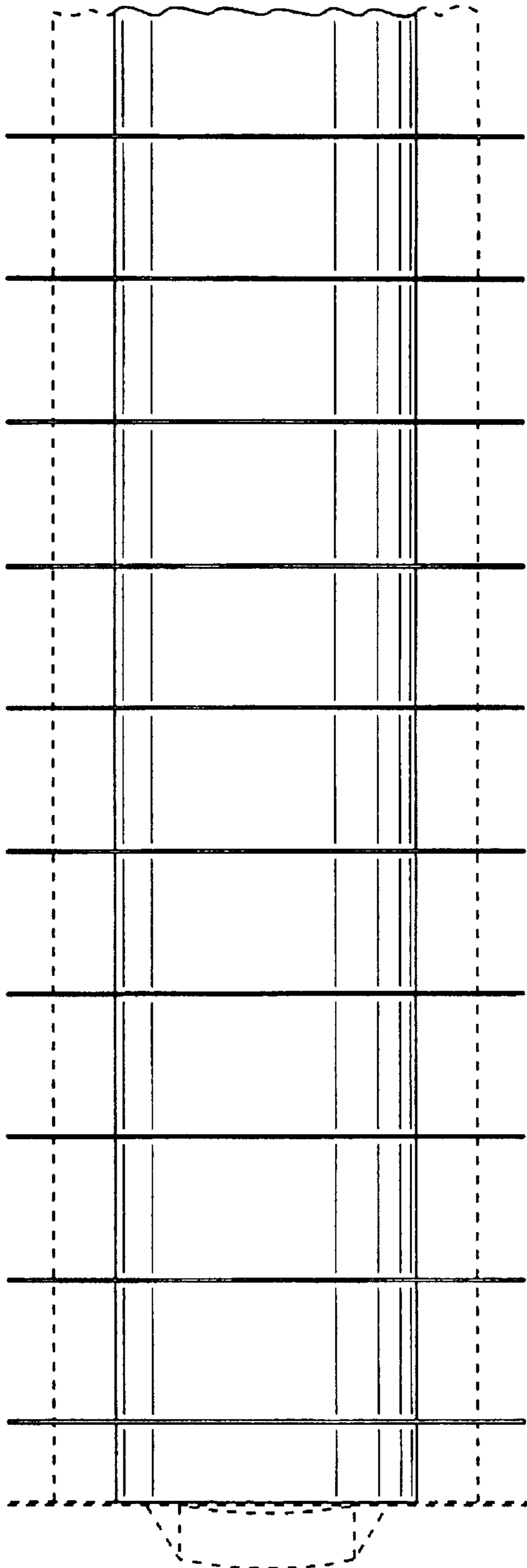

FIG. 3

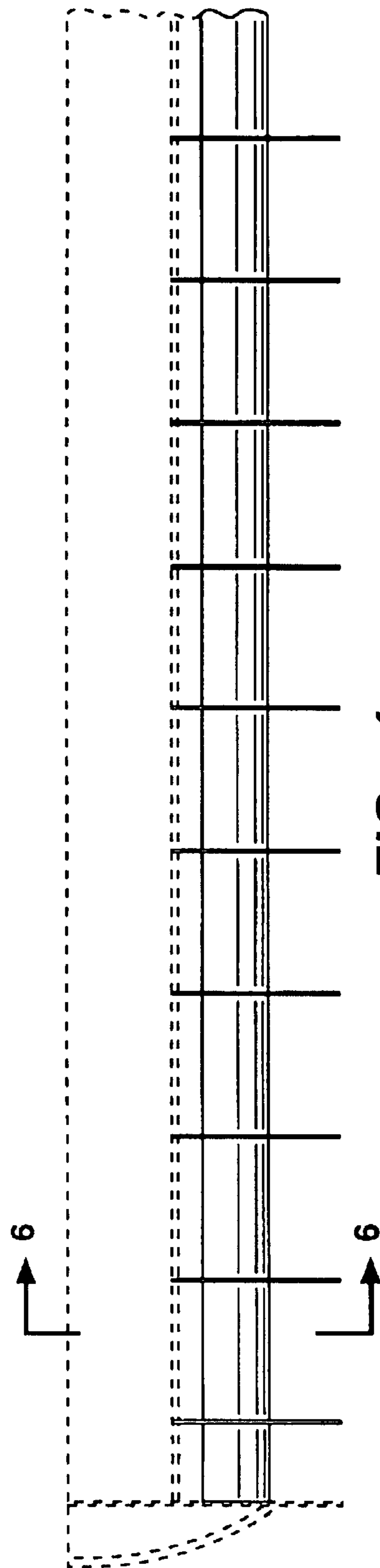

FIG. 4

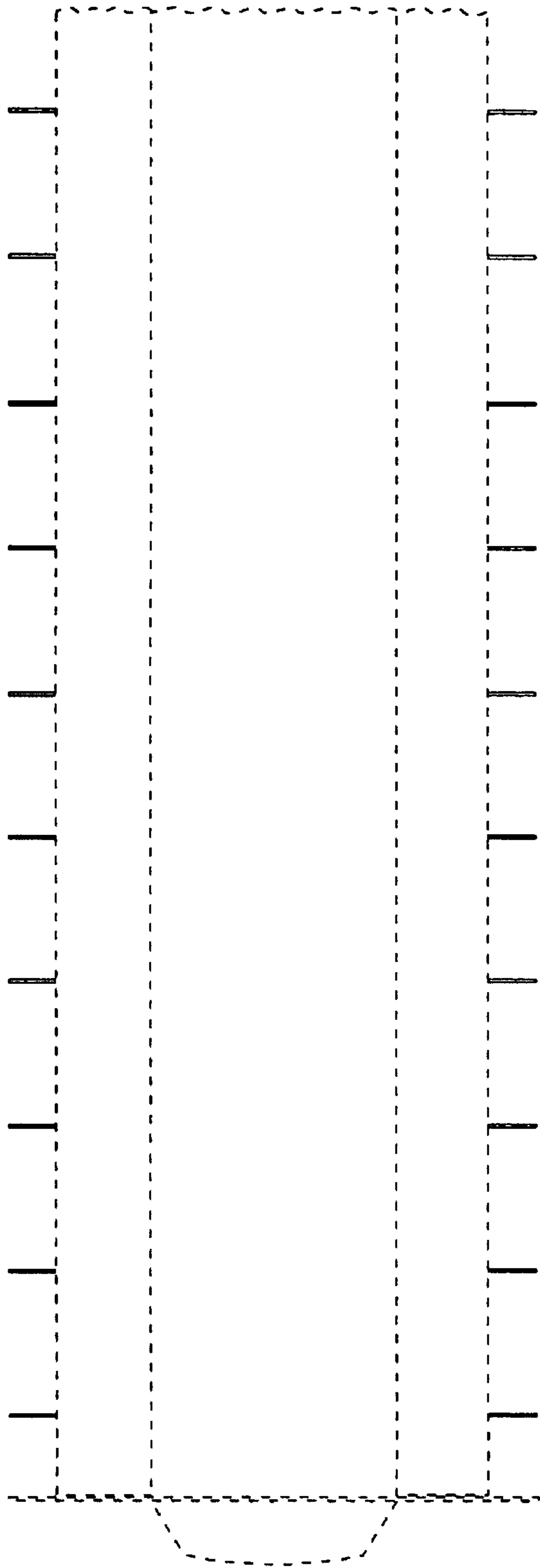

FIG. 5

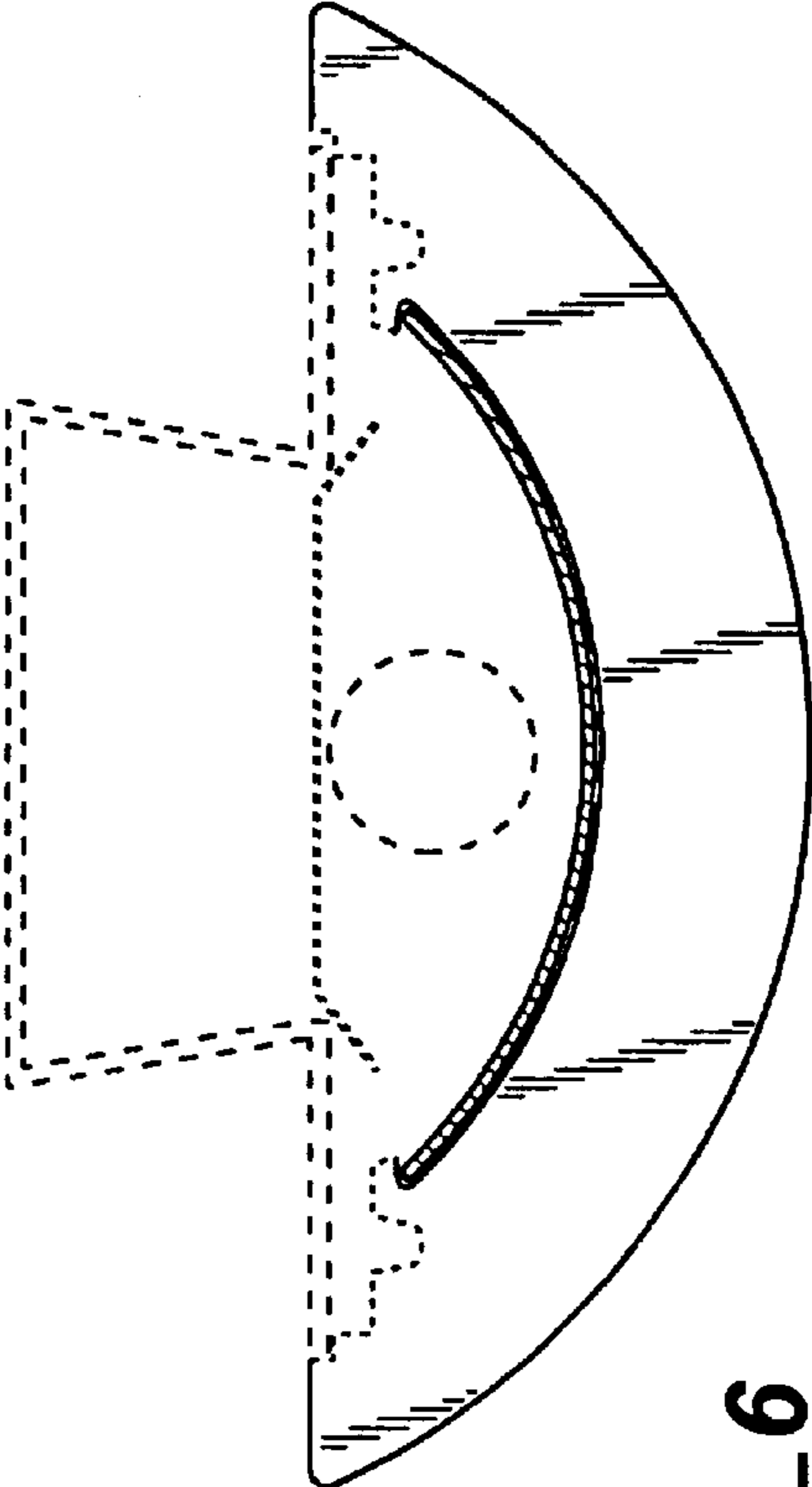

FIG. 6