



US00D522034S

(12) **United States Design Patent**
Yoo

(10) **Patent No.:** **US D522,034 S**

(45) **Date of Patent:** **** May 30, 2006**

(54) **DIGITAL CAMERA**

(75) **Inventor:** **Seung Seup Yoo, Seoungnam-si (KR)**

(73) **Assignee:** **Samsung Techwin Co., Ltd.,
Changwon (KR)**

(**) **Term:** **14 Years**

(21) **Appl. No.:** **29/218,743**

(22) **Filed:** **Dec. 7, 2004**

(30) **Foreign Application Priority Data**

Sep. 20, 2004 (KR) 30-2004-0029123

(51) **LOC (8) Cl.** **16-01**

(52) **U.S. Cl.** **D16/202**

(58) **Field of Classification Search** D16/200–205,
D16/208, 218; 348/373–376; 358/909.1;
396/6, 535–541

See application file for complete search history.

(56) **References Cited**

U.S. PATENT DOCUMENTS

D445,440 S * 7/2001 Chen D16/202
D450,073 S * 11/2001 Sumita D16/202
D480,742 S * 10/2003 Chin D16/202

D490,832 S * 6/2004 Yonekawa et al. D16/202
D494,612 S * 8/2004 Yang et al. D16/202
D495,351 S * 8/2004 Yi D16/202
D500,775 S * 1/2005 Iue D16/202
D505,967 S * 6/2005 Ko et al. D16/218

* cited by examiner

Primary Examiner—Adir Aronovich

(74) *Attorney, Agent, or Firm*—Gardner Carton & Douglas
LLP

(57) **CLAIM**

I claim the ornamental design for a digital camera, as shown
and described.

DESCRIPTION

FIG. 1 is a perspective view of the design for a digital
camera;

FIG. 2 is a front view of the design of FIG. 1;

FIG. 3 is a rear view of the design of FIG. 1;

FIG. 4 is a left side view of the design of FIG. 1;

FIG. 5 is a right side view of the design of FIG. 1;

FIG. 6 is a top view of the design of FIG. 1;

FIG. 7 is a bottom view of the design of FIG. 1; and,

FIG. 8 is a rear perspective view of the design of FIG. 1.

1 Claim, 5 Drawing Sheets

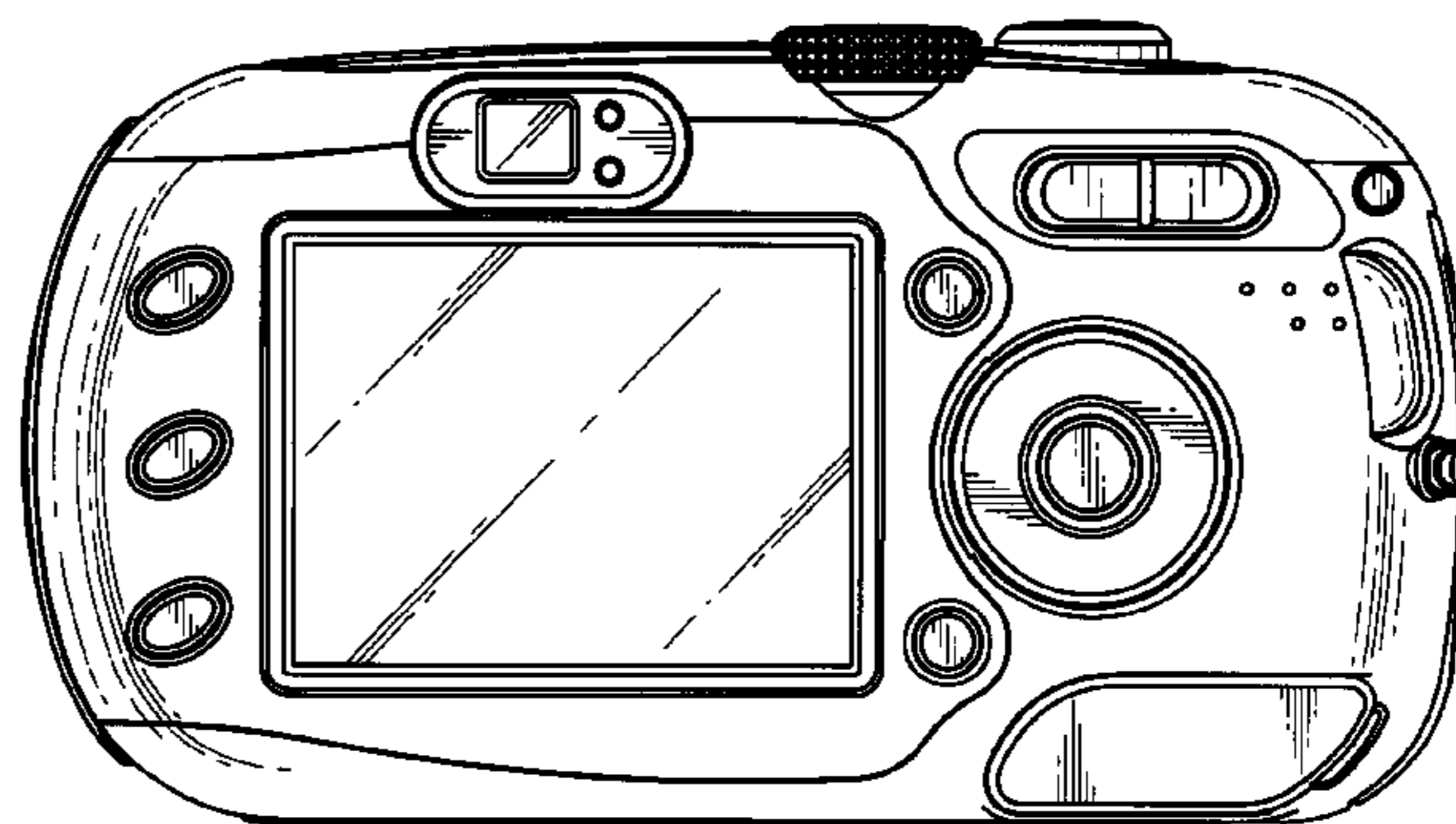
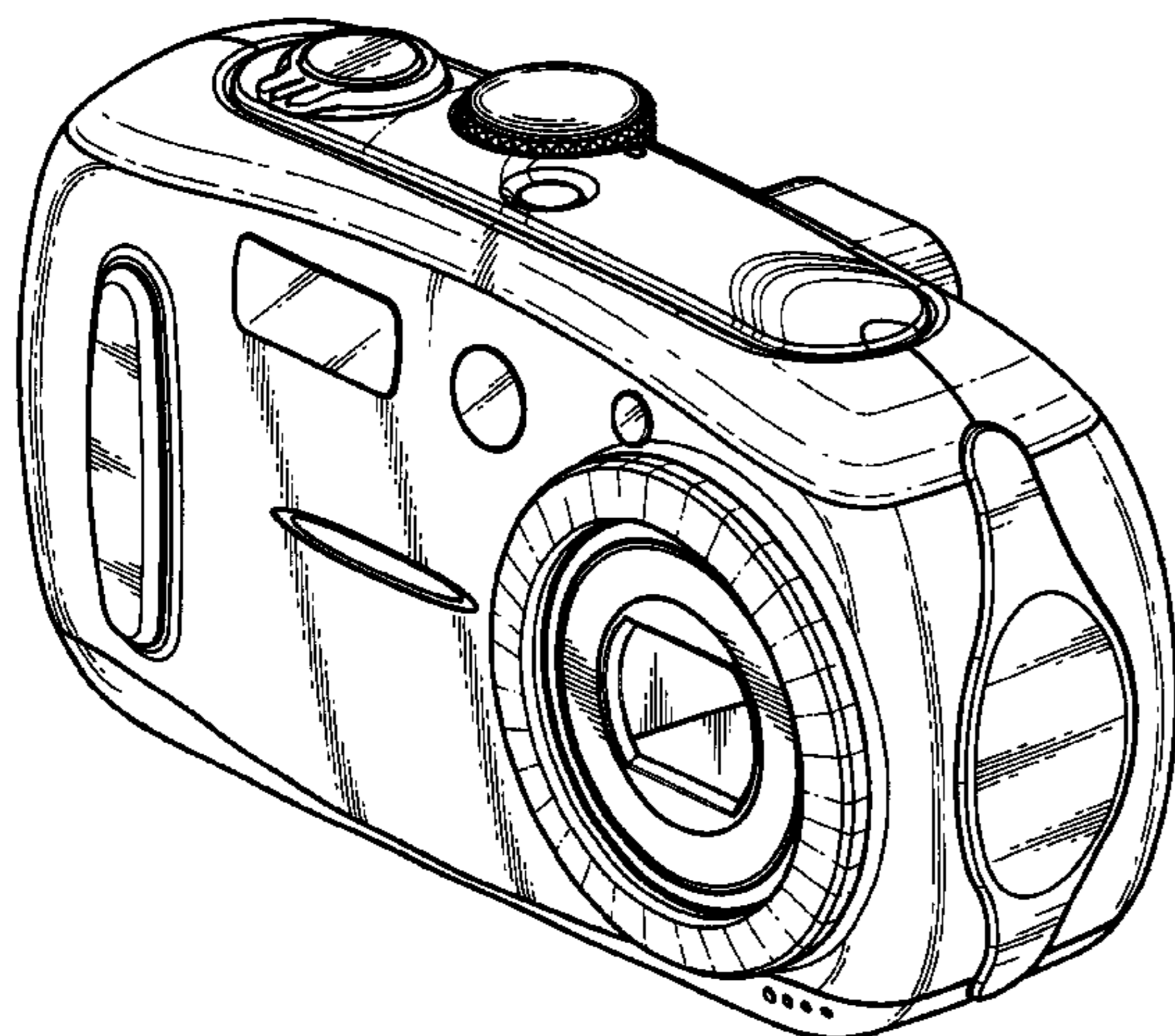

FIG. 1

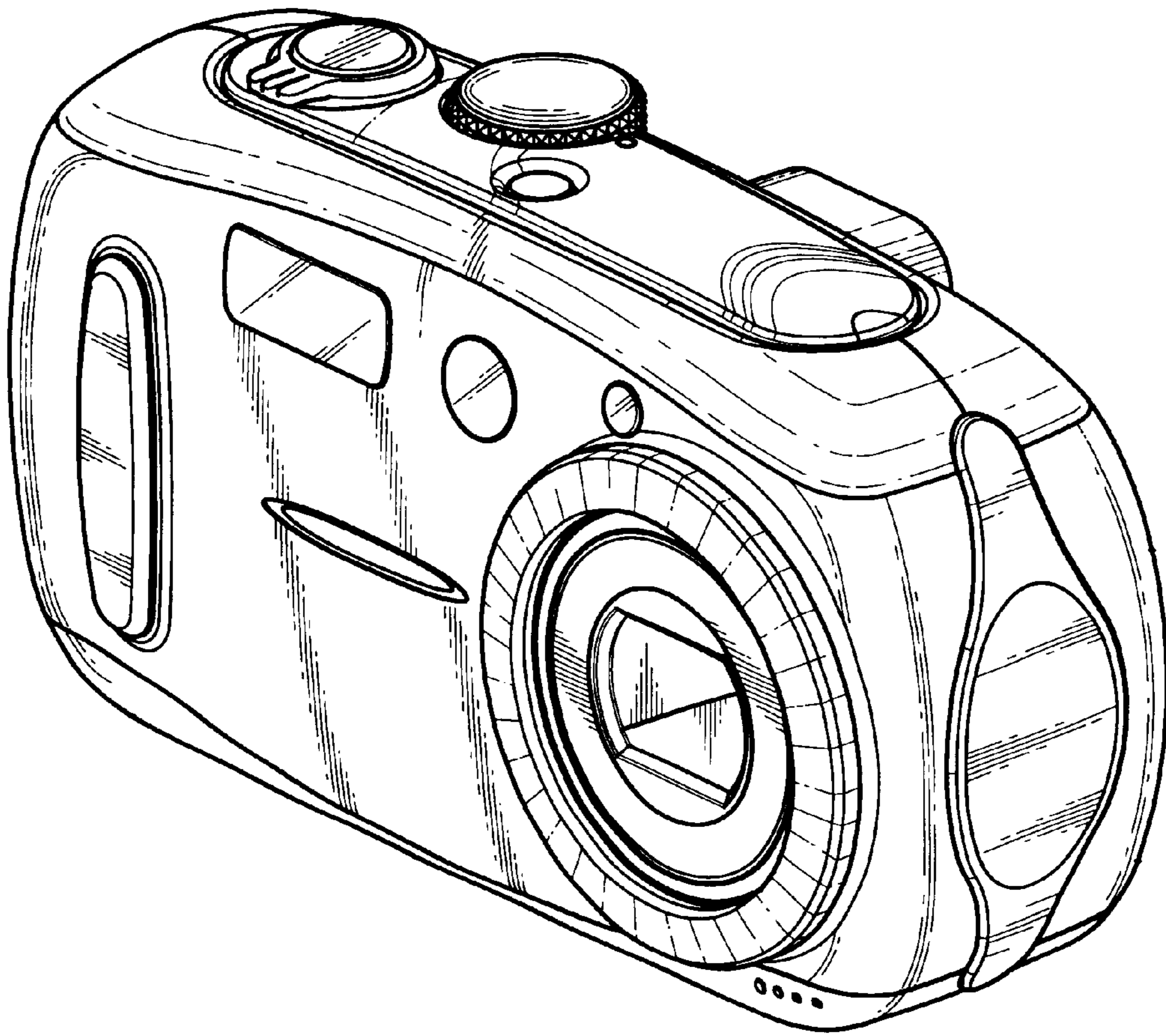

FIG. 2

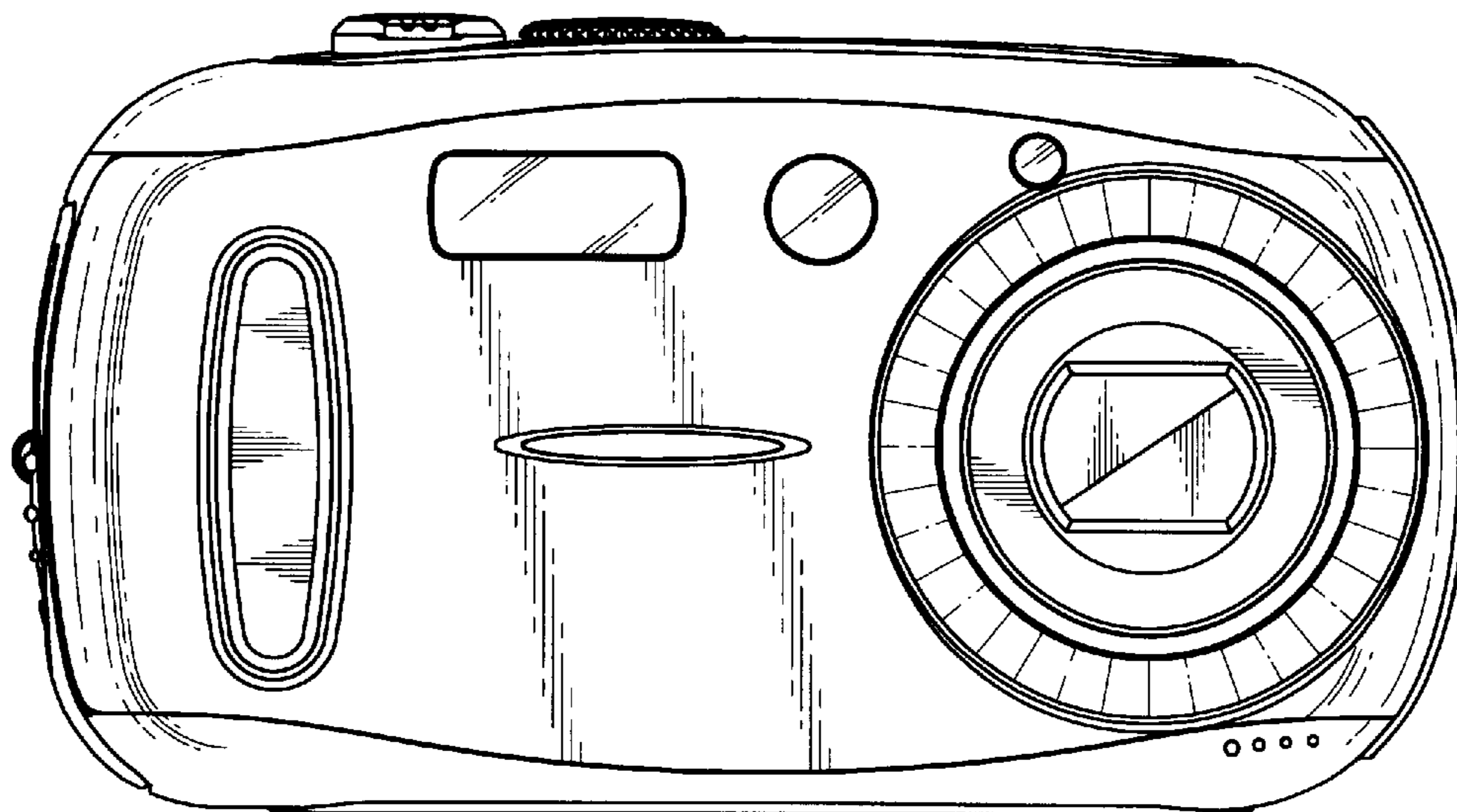

FIG. 3

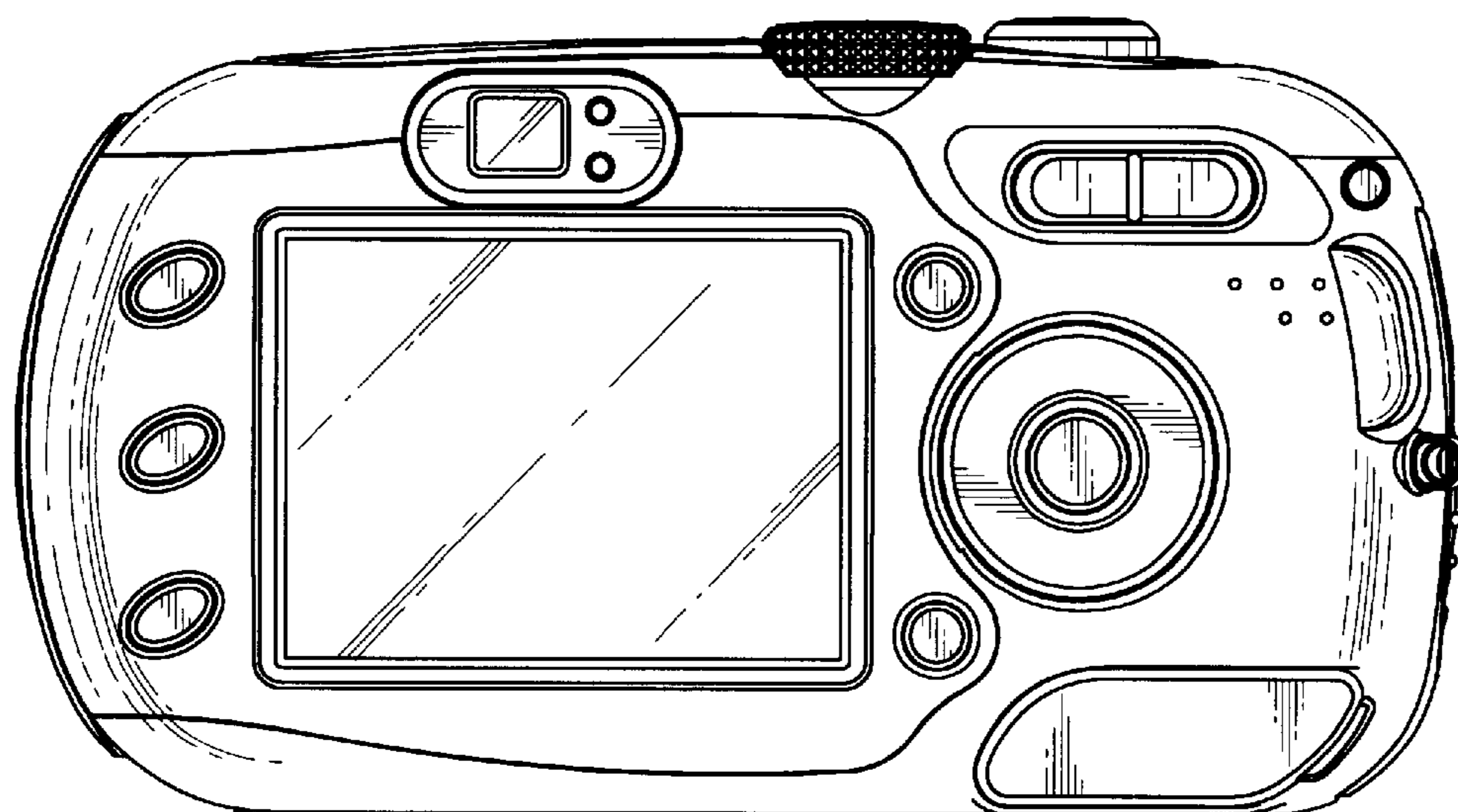

FIG. 4

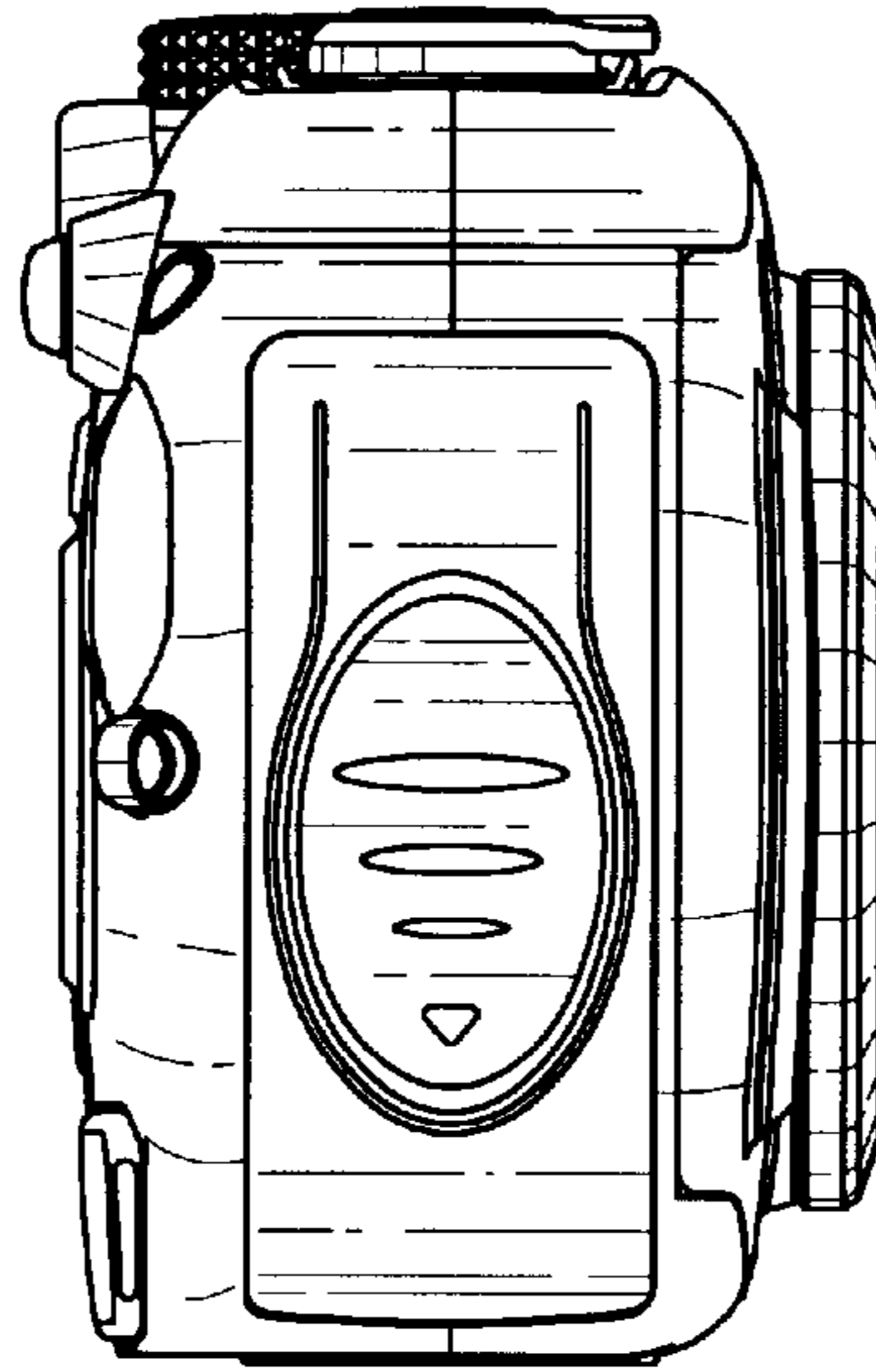

FIG. 5

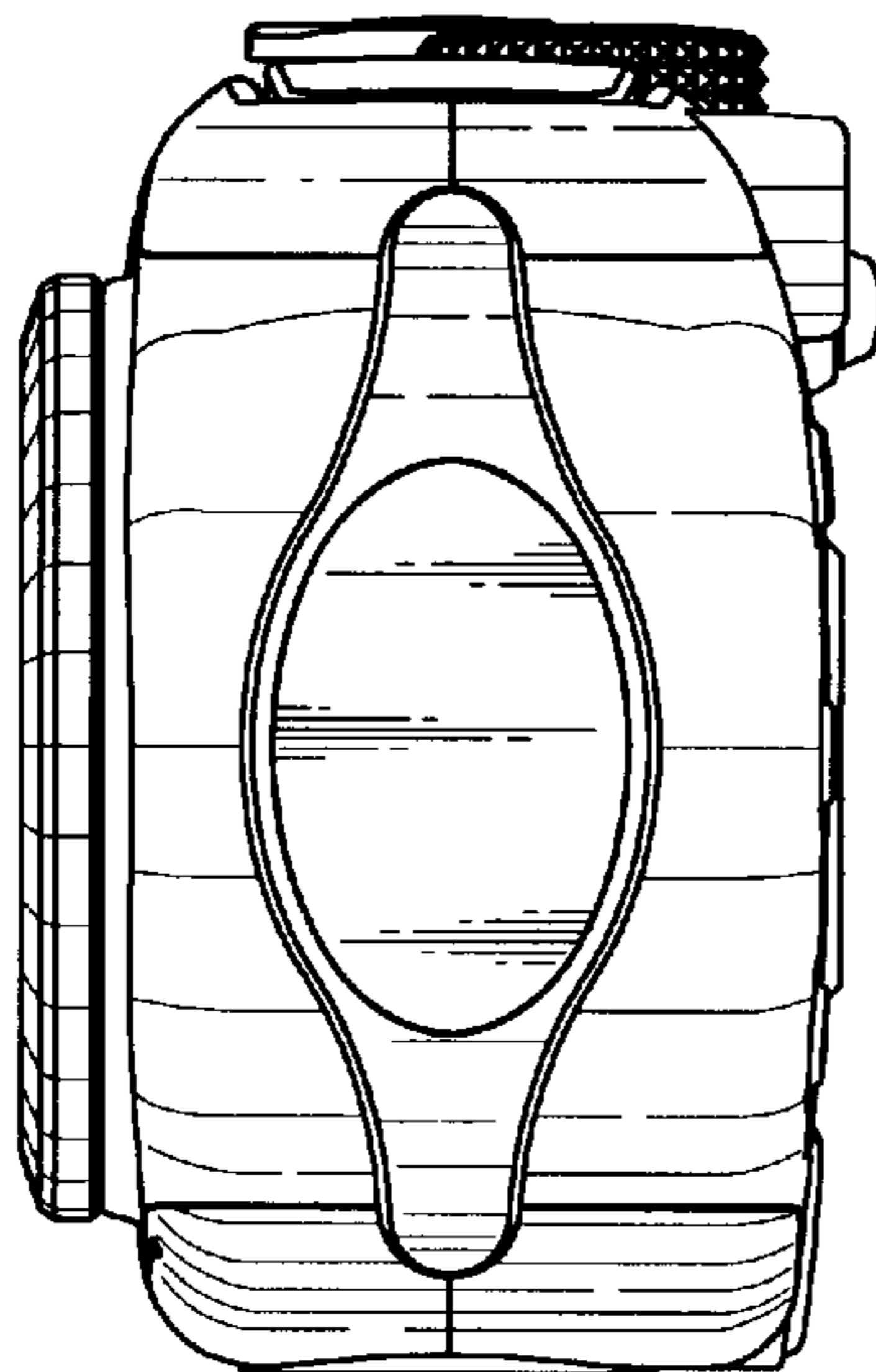

FIG. 6

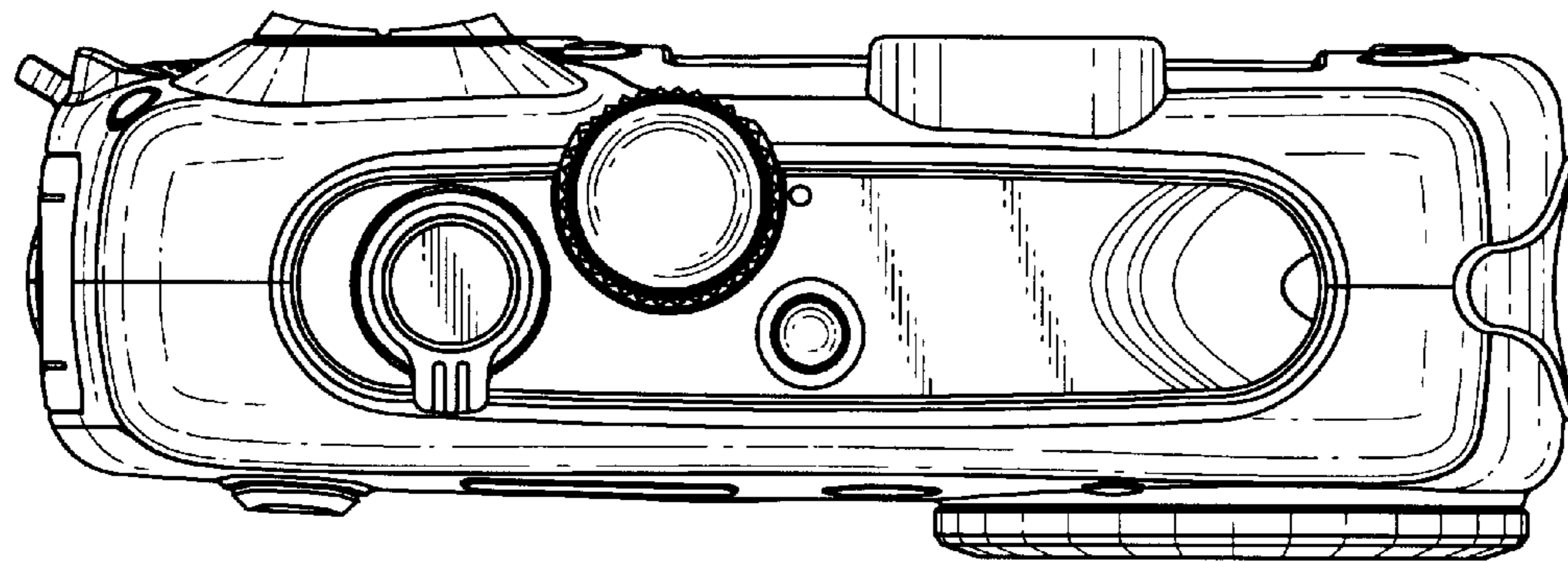

FIG. 7

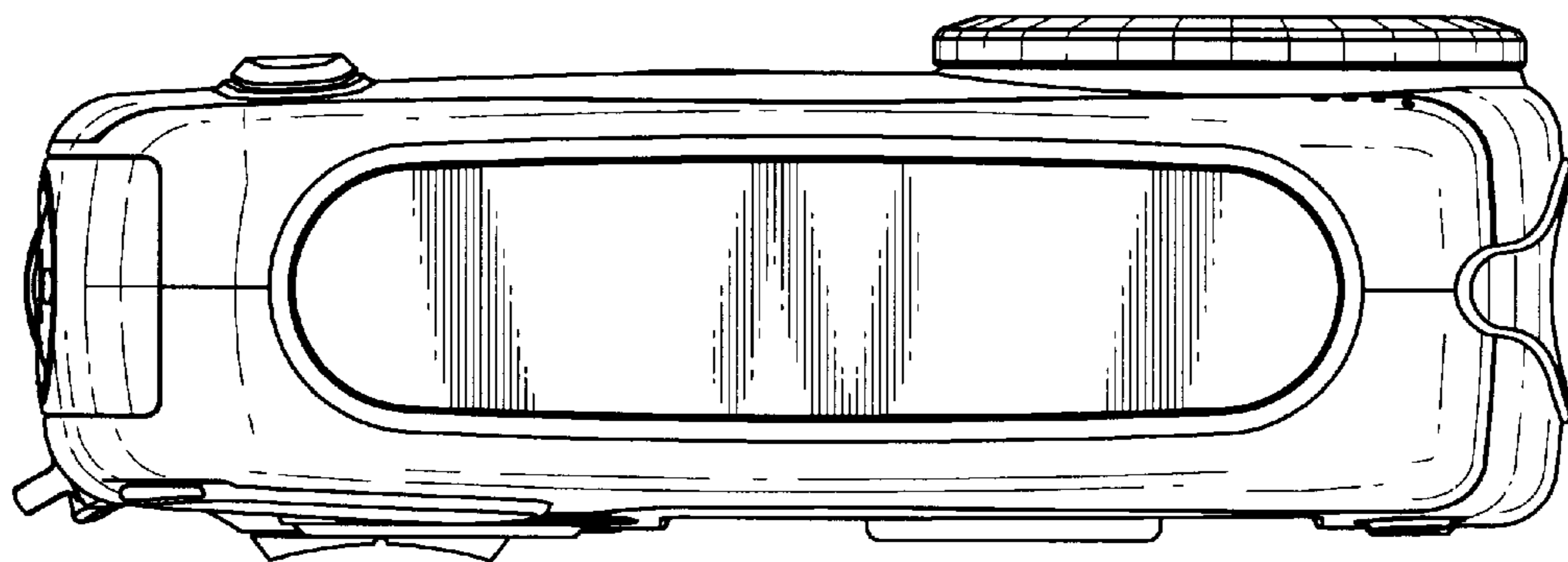

FIG. 8

