



US00D521958S

(12) **United States Design Patent**
Lin

(10) **Patent No.:** **US D521,958 S**

(45) **Date of Patent:** **** May 30, 2006**

(54) **TELEVISION SET**

(75) Inventor: **Roger Lin**, Taipei (TW)

(73) Assignee: **Hannspree Inc.**, Taipei (TW)

(**) Term: **14 Years**

(21) Appl. No.: **29/229,948**

(22) Filed: **May 16, 2005**

(30) **Foreign Application Priority Data**

Dec. 9, 2004 (TW) 93307450

(51) **LOC (8) Cl.** **14-03**

(52) **U.S. Cl.** **D14/126; D14/129**

(58) **Field of Classification Search** D14/125-134,
D14/239, 371, 136, 374-377; 312/7.2; 348/836,
348/838, 180, 184, 325, 739; 341/12; 248/917-924,
248/465; 345/104, 133, 156, 168, 87, 173;
720/605, 669, 600, 655; 369/99, 197; 455/344-347
See application file for complete search history.

(56) **References Cited**

U.S. PATENT DOCUMENTS

D374,464 S * 10/1996 Hutchins D21/331

D405,781 S * 2/1999 Renk D14/126

D406,613 S * 3/1999 Nakanishi D21/329

D415,147 S * 10/1999 Adachi D14/132

D429,287 S * 8/2000 Nara et al. D21/329

D444,712 S * 7/2001 Versace D10/26

D468,215 S * 1/2003 Hsu D10/15

D475,933 S * 6/2003 Hsu D10/15

D493,153 S * 7/2004 Zhai et al. D14/126

* cited by examiner

Primary Examiner—Raphael Barkai

(74) *Attorney, Agent, or Firm*—Rosenberg, Klein & Lee

(57) **CLAIM**

The ornamental design for a television set, as shown and described.

DESCRIPTION

FIG. 1 is a perspective view of a television set showing my new design;

FIG. 2 is a front view thereof;

FIG. 3 is a rear view thereof;

FIG. 4 is a left view thereof;

FIG. 5 is a right view thereof;

FIG. 6 is a top view thereof; and,

FIG. 7 is a bottom view thereof.

1 Claim, 4 Drawing Sheets

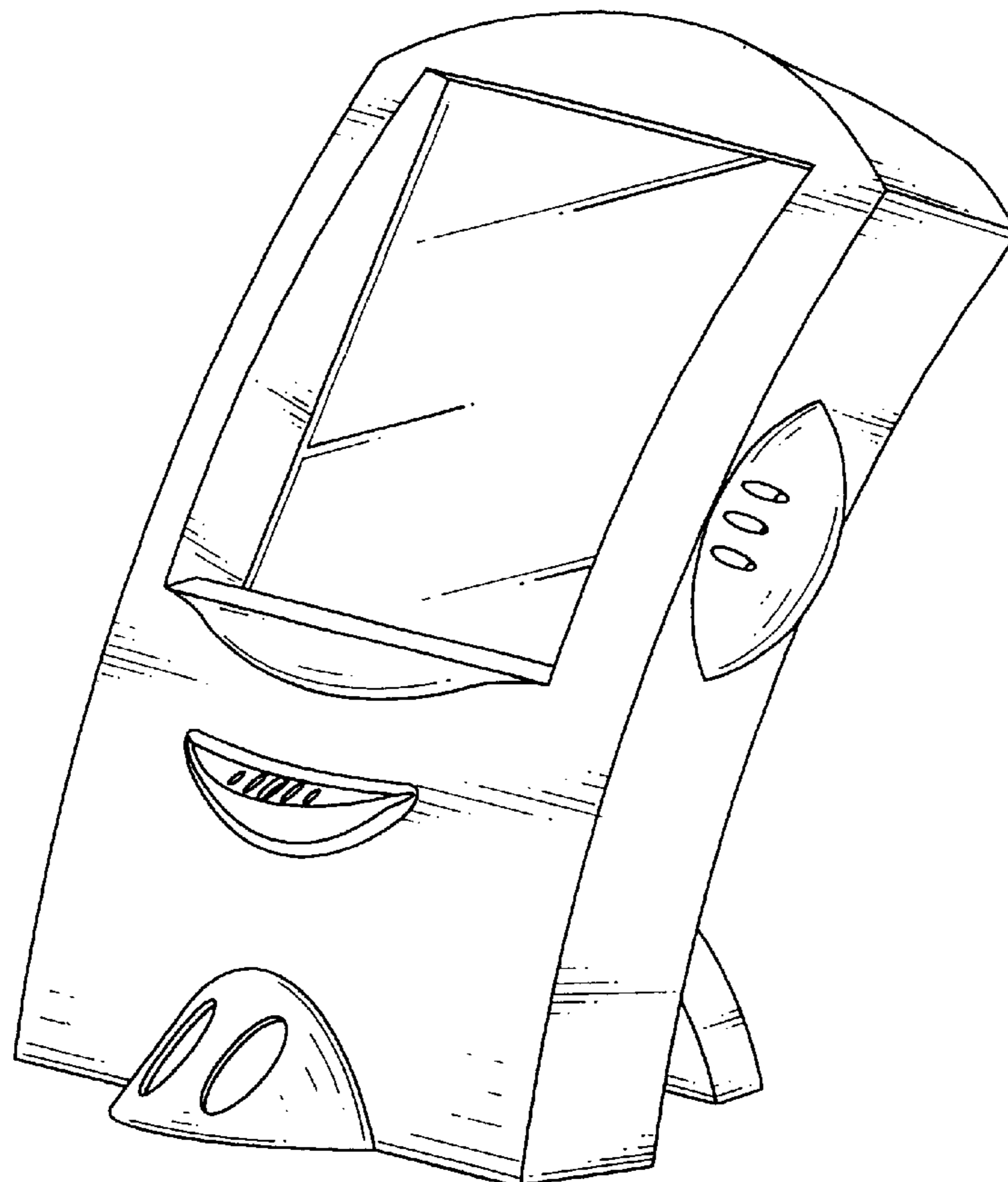

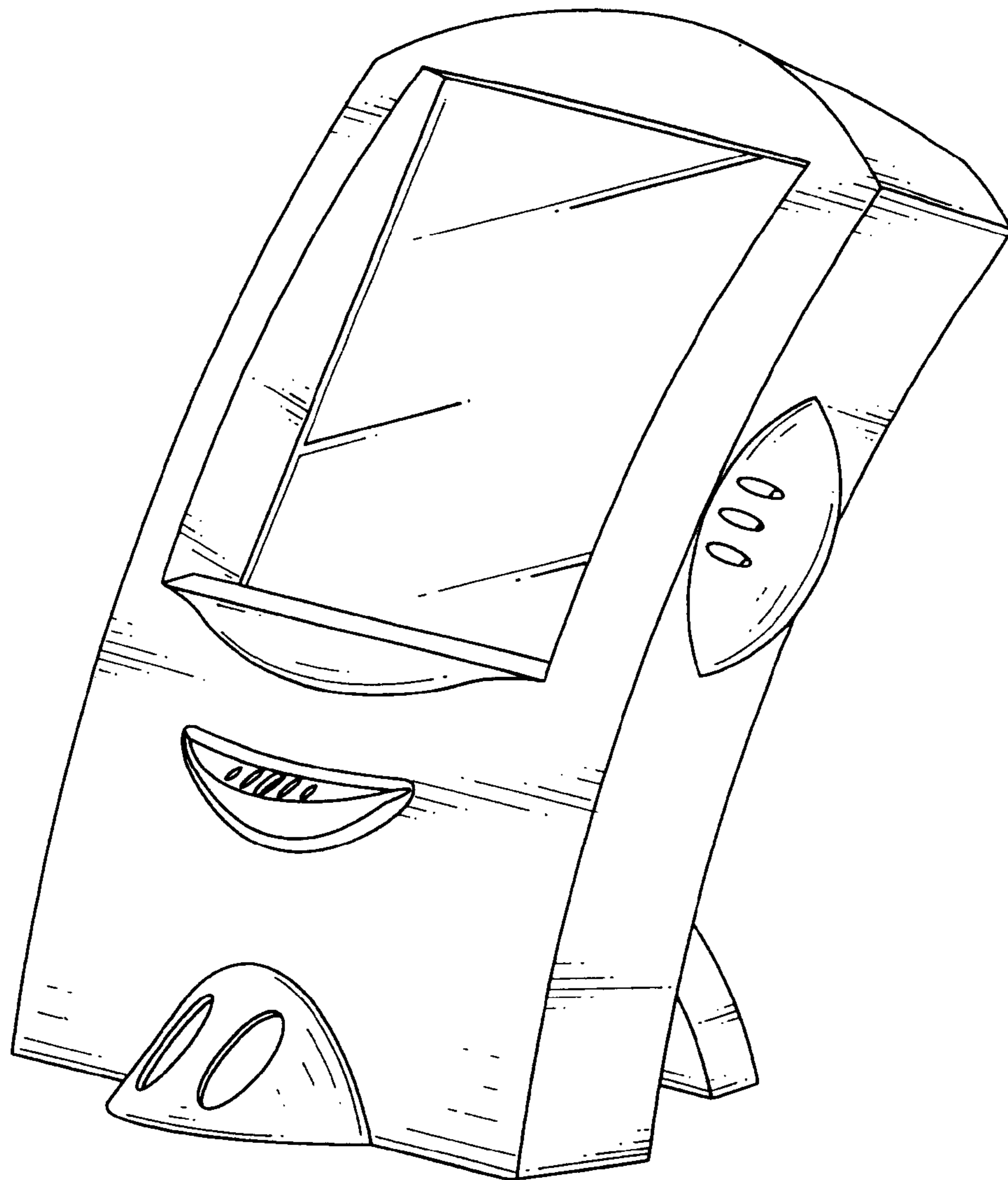

FIG. 1

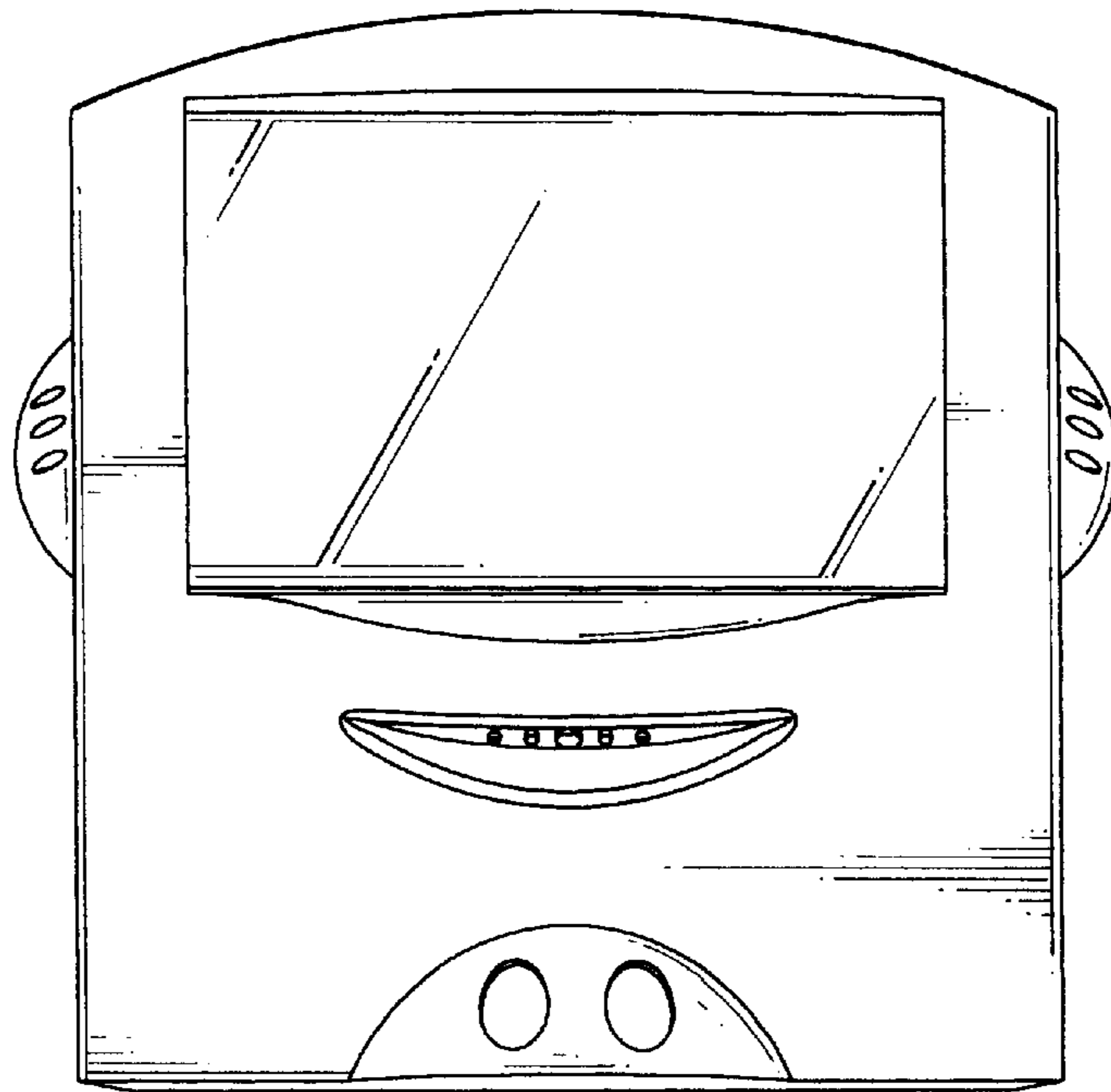

FIG. 2

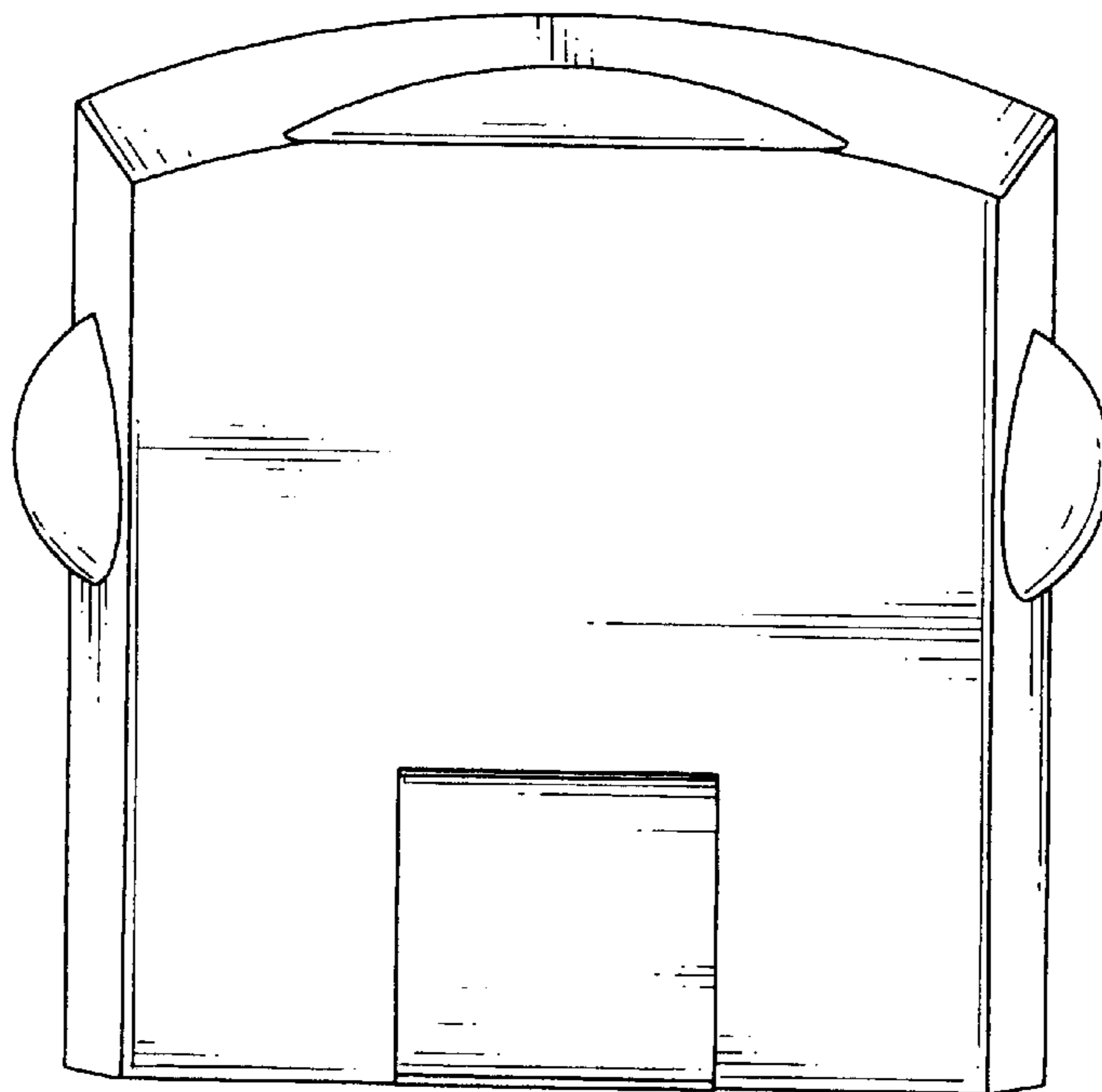

FIG. 3

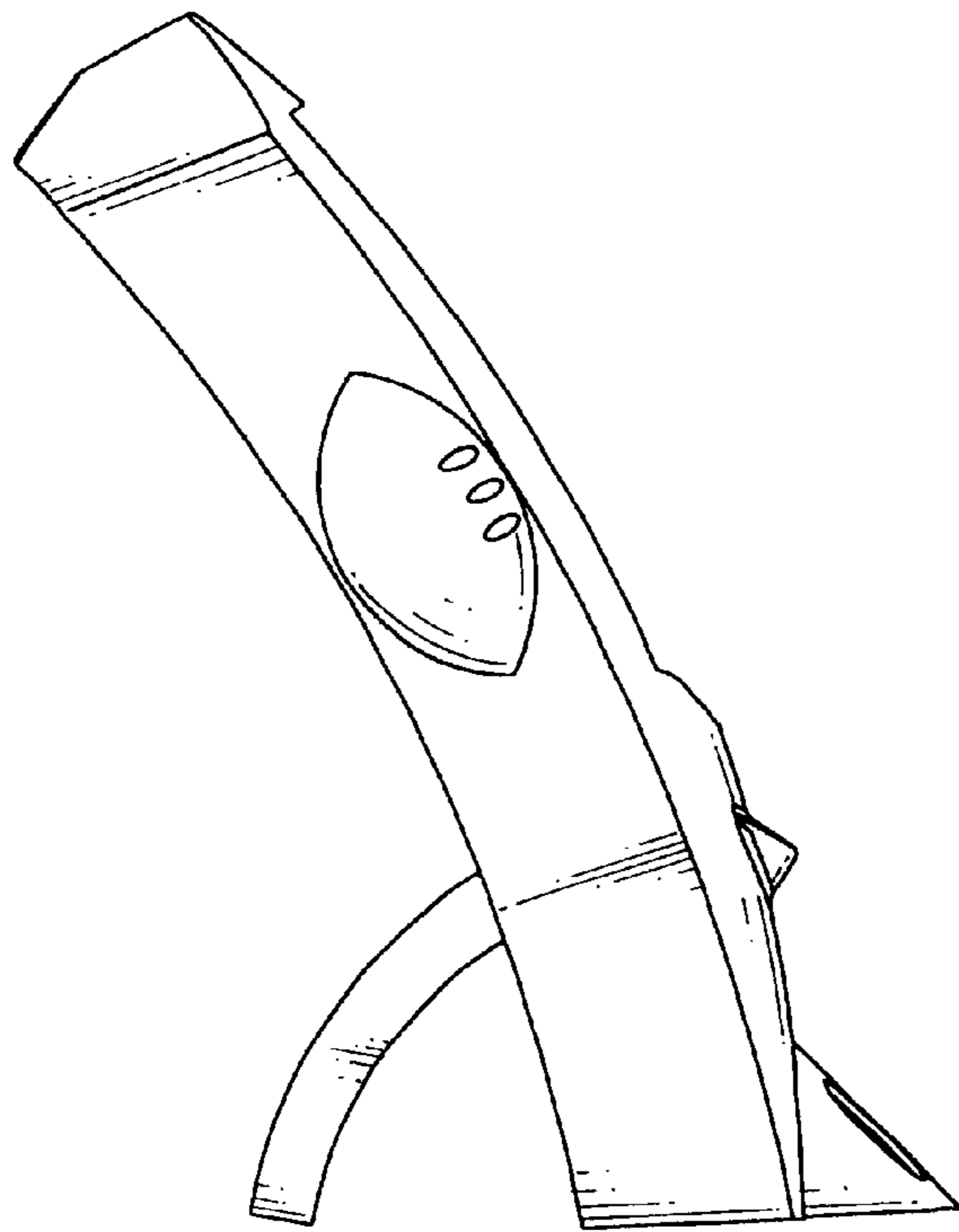

FIG. 4

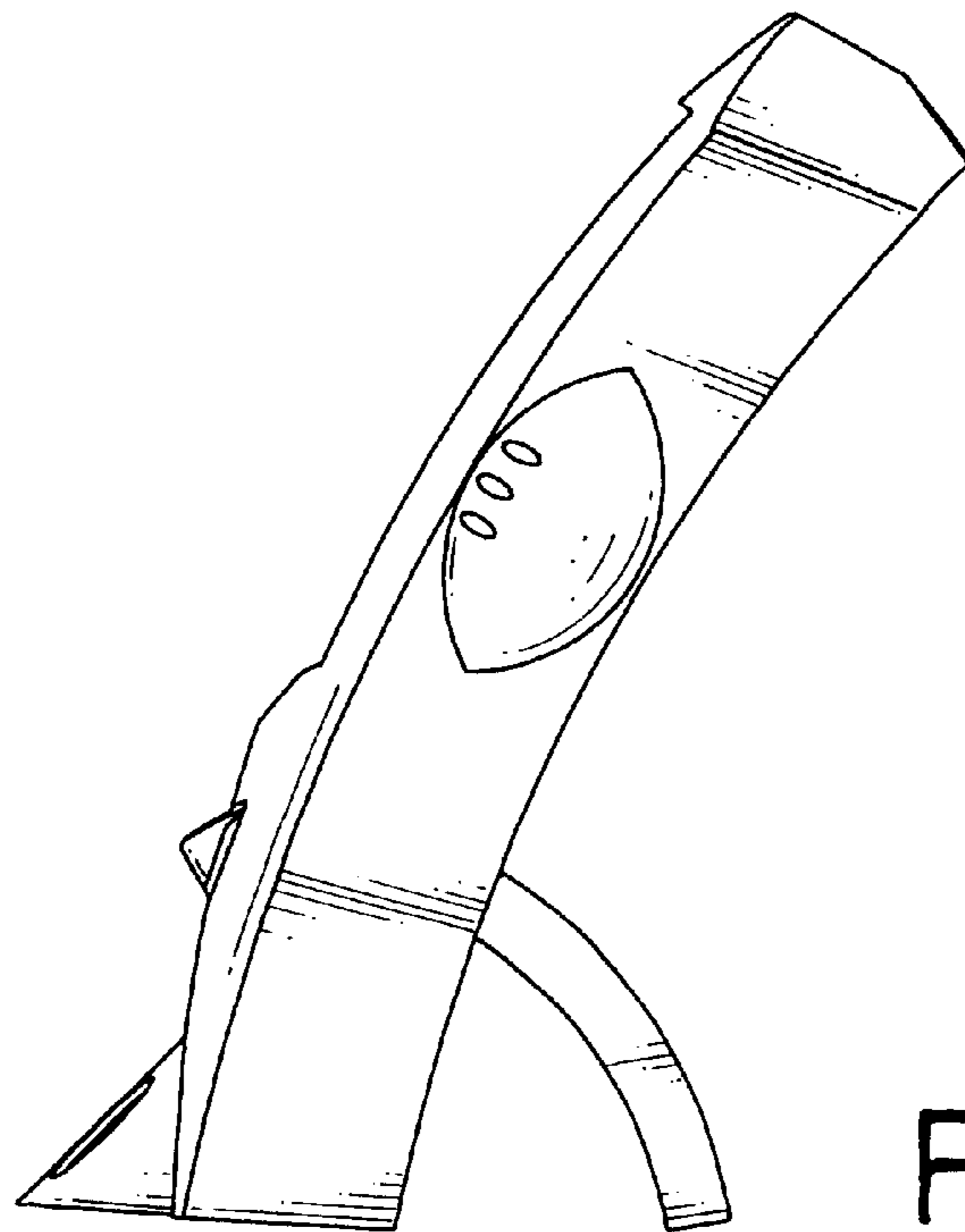

FIG. 5

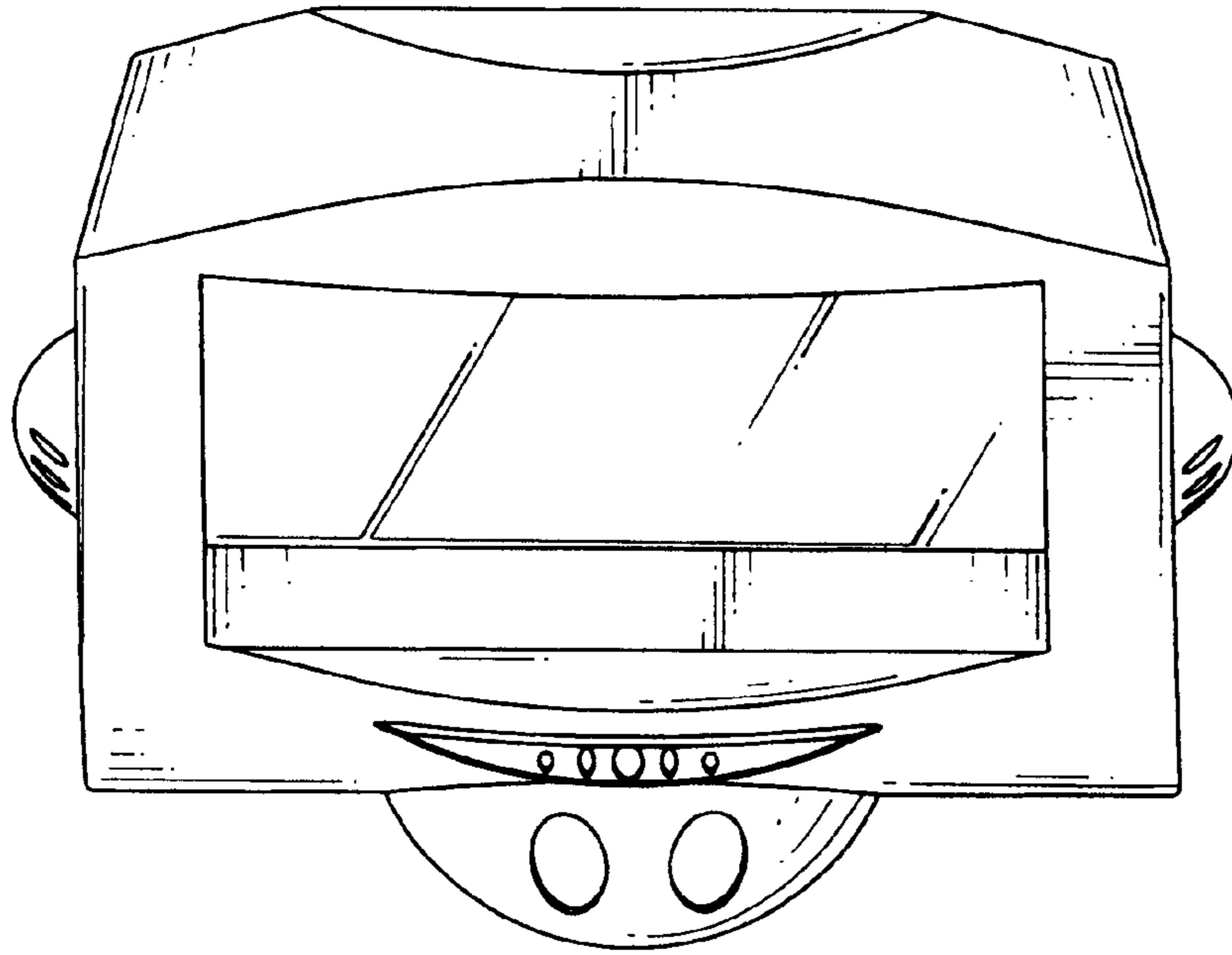

FIG. 6

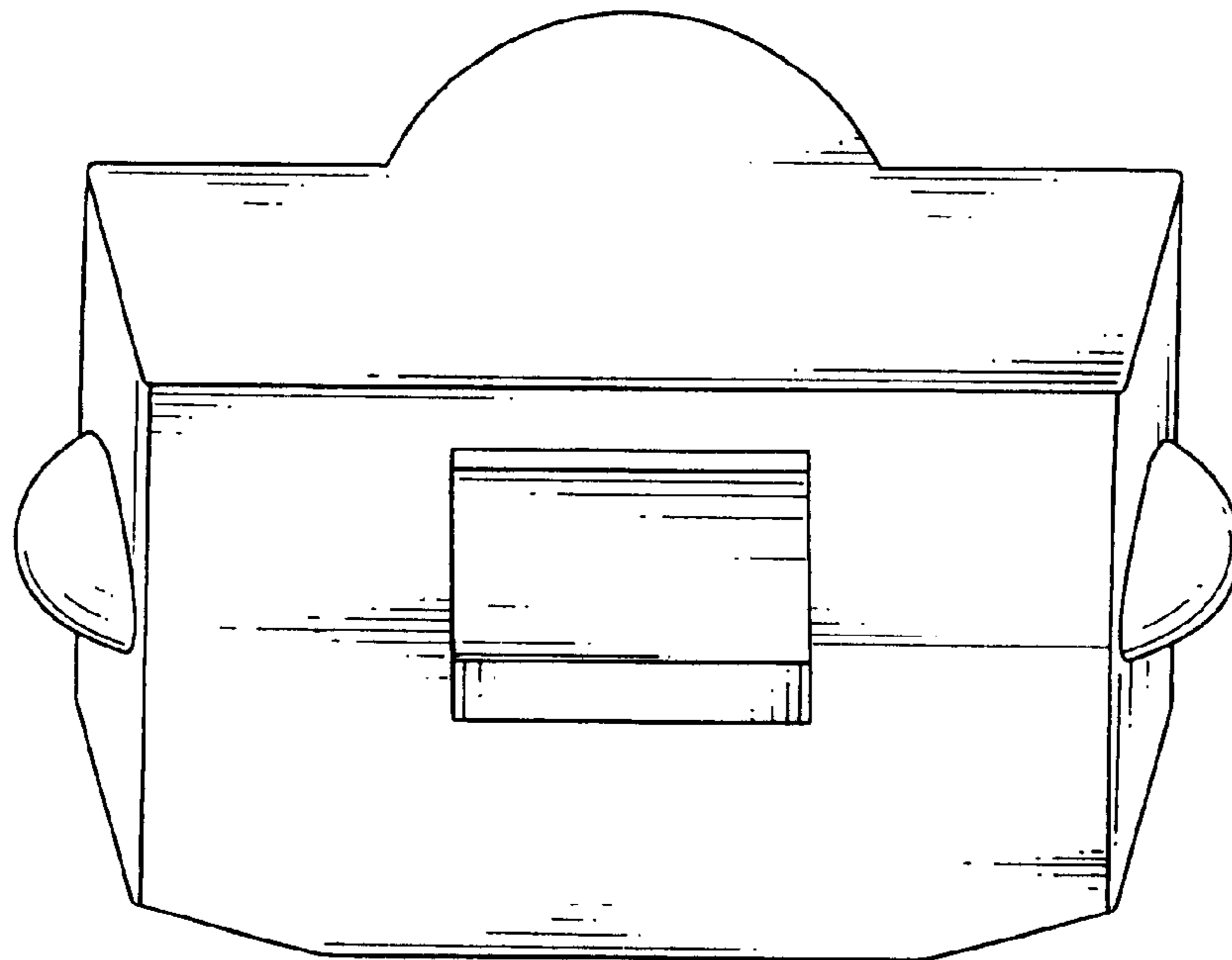

FIG. 7