



US00D521843S

(12) **United States Design Patent**  
**Hung**

(10) **Patent No.:** **US D521,843 S**

(45) **Date of Patent:** **\*\* May 30, 2006**

(54) **HEAD OF A HATCHET**

D378,656 S \* 4/1997 Maine ..... D8/78

(76) Inventor: **Yi-Kung Hung**, No. 29, Putou St.,  
Lochin Li, Lukang Chen, Changhua  
Hsien (TW)

(\*\*) Term: **14 Years**

(21) Appl. No.: **29/222,991**

(22) Filed: **Feb. 8, 2005**

(51) **LOC (8) Cl.** ..... **08-02**

(52) **U.S. Cl.** ..... **D8/78; D8/76**

(58) **Field of Classification Search** ..... D8/75,  
D8/76, 77, 78, 79, 80, 81; 81/19, 20, 21,  
81/22, 23; 7/143, 144, 145, 146; 254/26 R,  
254/26 E; 30/308.1, 308.2

See application file for complete search history.

(56) **References Cited**

**U.S. PATENT DOCUMENTS**

3,233,643	A	*	2/1966	Reutersfors	.....	7/158
D209,381	S	*	11/1967	Reuterfors	.....	D8/76
D257,826	S	*	1/1981	Jones	.....	D8/78
4,242,780	A	*	1/1981	Littman	.....	29/81.17
D264,798	S	*	6/1982	Jones	.....	D8/78
D266,141	S	*	9/1982	Nannen	.....	D8/76
4,357,974	A	*	11/1982	Nannen	.....	30/308.1
D271,076	S	*	10/1983	Hillinger	.....	D8/76
4,926,558	A	*	5/1990	Brace	.....	30/308.1

**OTHER PUBLICATIONS**

Ben Meadows Catalog, Fall 2002, p. 109, axes, found on  
Google Catalogs search engine.\*

Diamond Pacific catalog, 2002, p. 98, hammers, found on  
Google Catalogs Search engine.\*

\* cited by examiner

*Primary Examiner*—Philip S. Hyder

(74) *Attorney, Agent, or Firm*—Rosenberg, Klein & Lee

(57) **CLAIM**

The ornamental design for a head of a hatchet, as shown and  
described.

**DESCRIPTION**

FIG. 1 is a perspective view of a head of a hatchet, showing  
my new design;

FIG. 2 is a front view thereof;

FIG. 3 is a rear view thereof;

FIG. 4 is a left view thereof;

FIG. 5 is a right view thereof;

FIG. 6 is a top view thereof; and,

FIG. 7 is a cross sectional bottom plan view thereof along  
line 7—7 in FIG. 2.

The broken line showings of the handle are for illustrative  
purposes only and form no part of the claimed design.

**1 Claim, 5 Drawing Sheets**

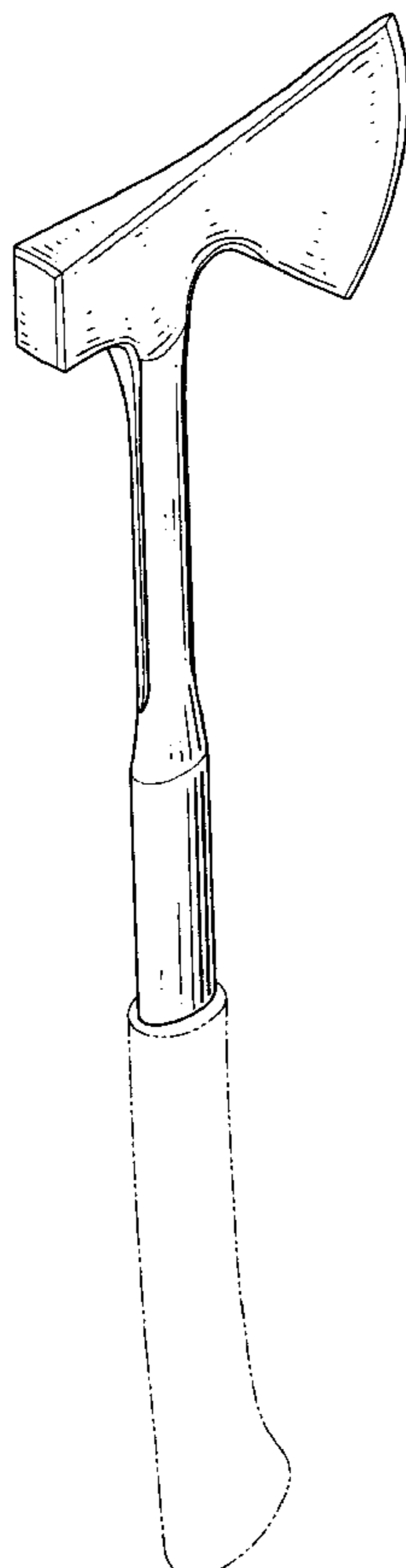

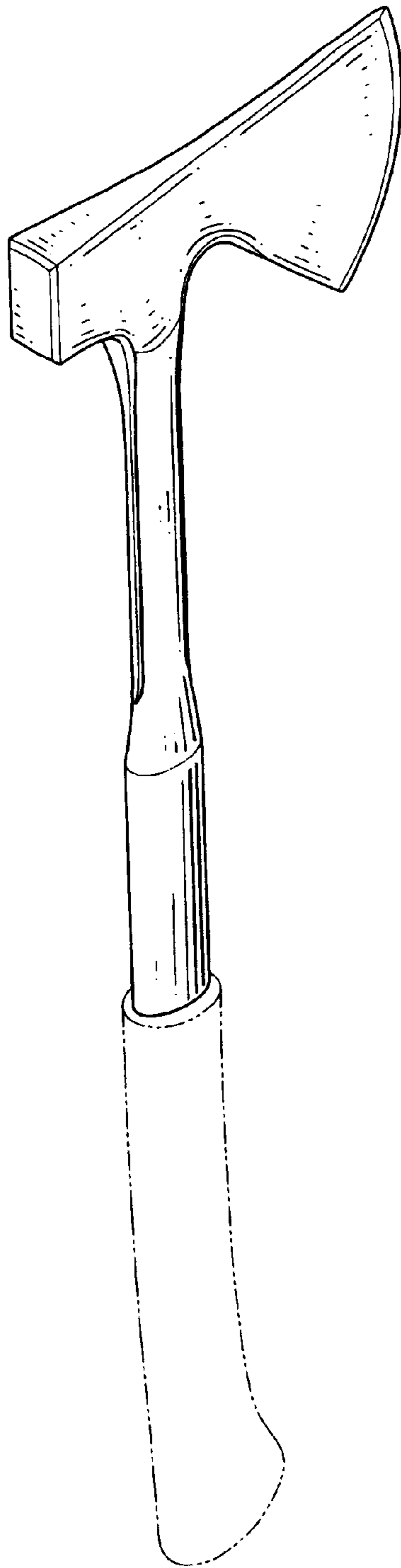

FIG. 1

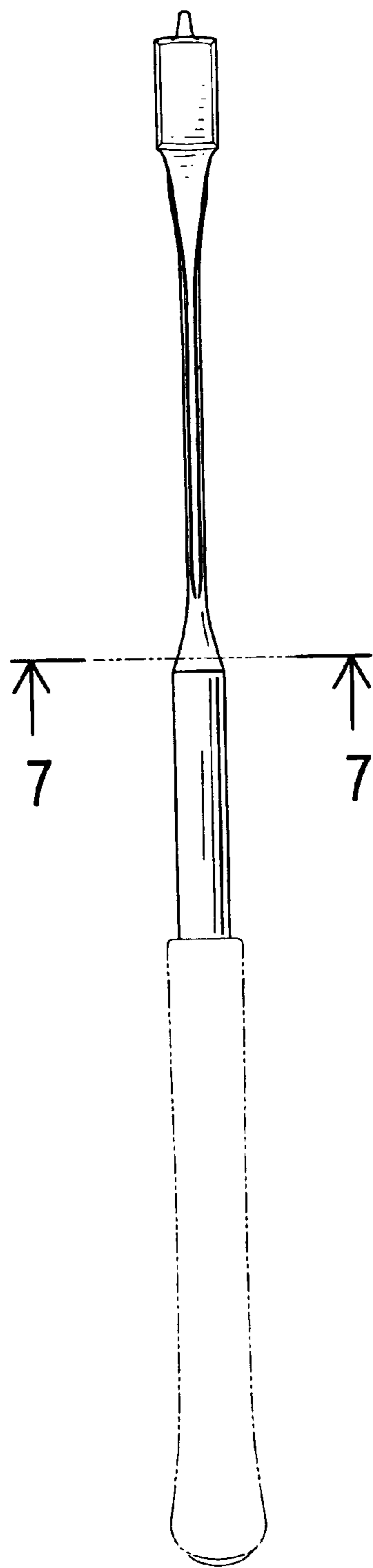

FIG. 2



FIG. 3

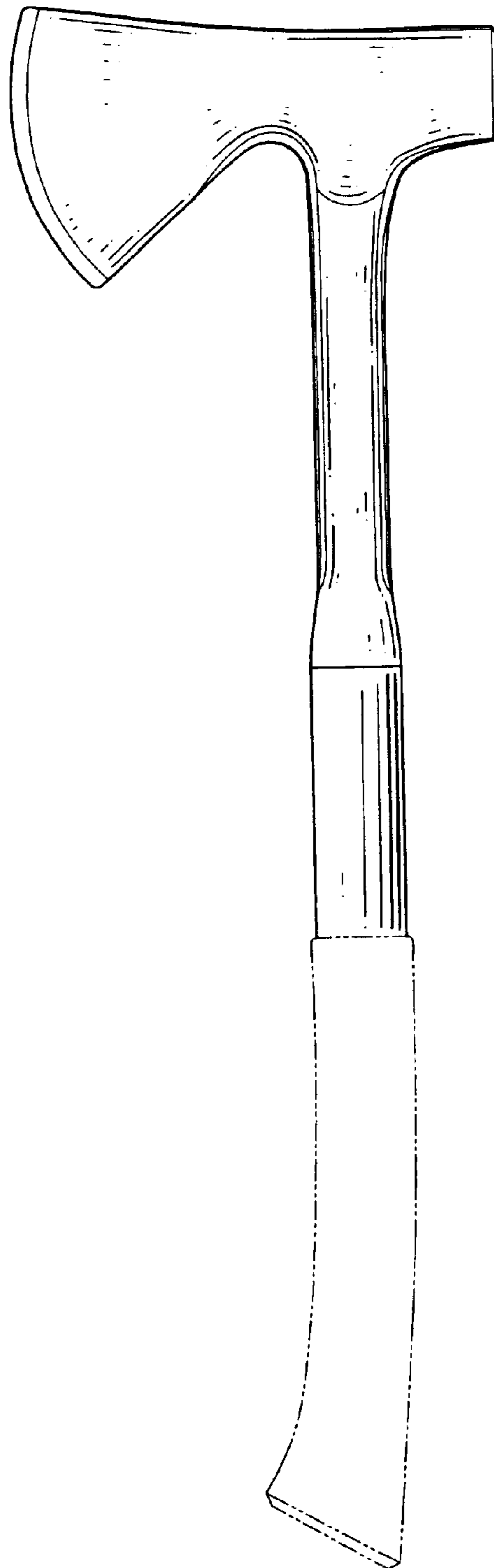

FIG.4

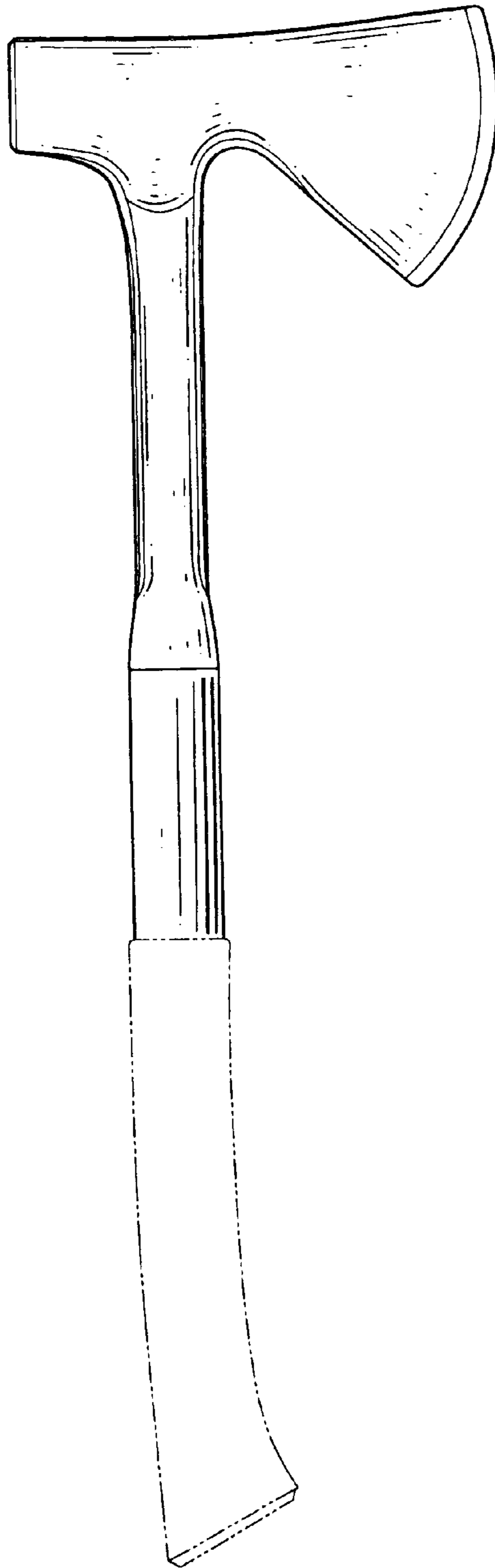

FIG. 5

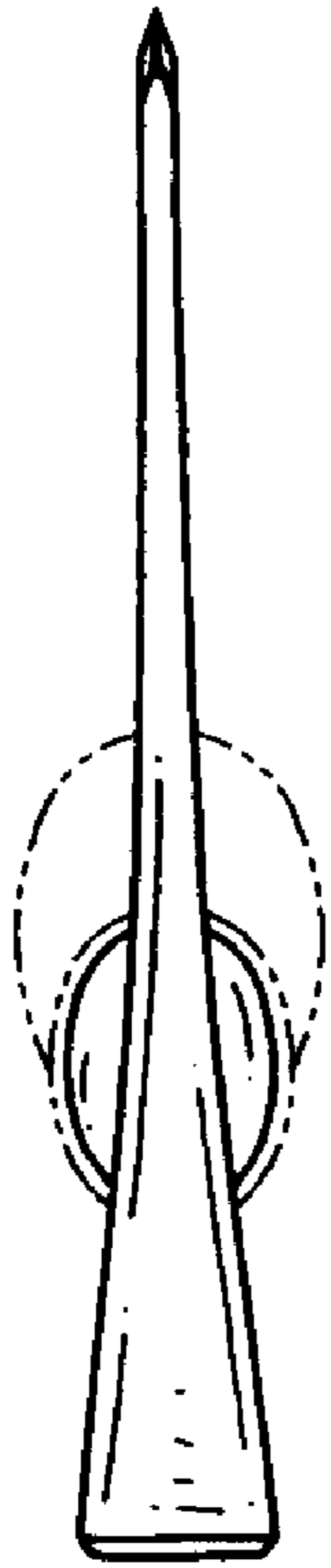

FIG. 6

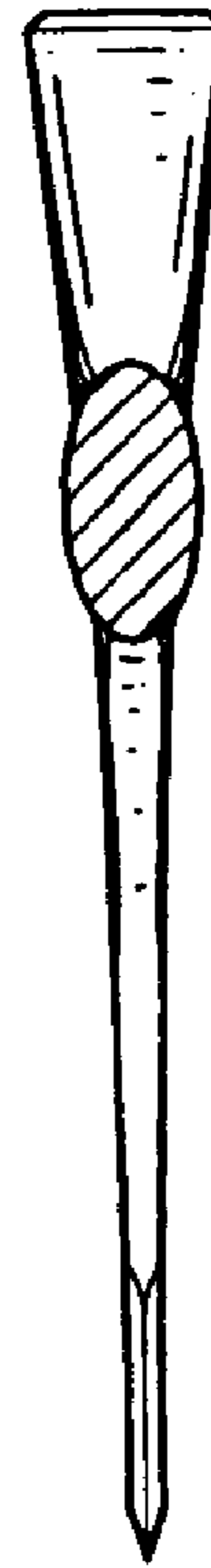

FIG. 7