

US00D521769S

(12) **United States Design Patent** (10) **Patent No.:** **US D521,769 S**
Israel et al. (45) **Date of Patent:** **** May 30, 2006**

(54) **BLANKET HANGER**

OTHER PUBLICATIONS

(76) Inventors: **David L. Israel**, N. 27412 Dalton Rd.,
Deer Park, WA (US) 99006; **Becky**
Israel, N. 27412 Dalton Rd., Deer Park,
WA (US) 99006

Website, abbeysaddlery.co.uk/catalogue/product-description.asp?id=5250, "S91 5 Arm Rug Rack" from Abbey Saddlery, printed Jan. 18, 2005.

Website, "sstack.com/jump.jsp?itemID=137&itemtype=INDEX&iMainCat=133&iSubCat=137&page=2&sort=0" "Easy-Up Swing Arm Rack" from Schneider Saddlery, printed Jan. 18, 2005.

(**) Term: **14 Years**

Website "horsehealthusa.com/cgi-local/SoftCart.exe/supplies/padsblanketholders.html?L+scstore+bsmg9568ff940594+1106769323" "Five Swinging Blanket Bar" from Horse Health USA, printed Jan. 19, 2005.

(21) Appl. No.: **29/223,037**

(22) Filed: **Feb. 9, 2005**

(51) **LOC (8) Cl.** **06-01**

(52) **U.S. Cl.** **D6/410**

(58) **Field of Classification Search** D6/410-411;
211/90.03, 106, 85.3, 85.5, 85.11, 100, 96
See application file for complete search history.

* cited by examiner

Primary Examiner—Antoine Duval Davis

Assistant Examiner—Sydney R. Buffalow

(74) *Attorney, Agent, or Firm*—Richard C. Litman

(56) **References Cited**

(57) **CLAIM**

U.S. PATENT DOCUMENTS

The ornamental design for a blanket hanger, as shown and described.

275,478	A	*	4/1883	Geishaker	211/100
1,153,677	A	*	9/1915	Deragon	211/96
1,162,298	A		11/1915	Metcalf		
1,240,611	A		9/1917	Smith		
1,378,692	A		5/1921	Leffel		
1,497,209	A	*	6/1924	Chapman	211/100
D134,111	S		10/1942	Bersin et al.		
2,475,964	A		7/1949	Hughey		
3,729,099	A		4/1973	Kritske		
4,232,791	A		11/1980	Howard		
4,723,665	A	*	2/1988	Benedict et al.	211/168
5,452,809	A		9/1995	Capel		
5,535,896	A	*	7/1996	Morgan, Sr.	211/96
6,206,210	B1		3/2001	Reed		

DESCRIPTION

FOREIGN PATENT DOCUMENTS

JP 52-52400 4/1977

FIG. 1 is a front elevation view of a blanket hanger showing my new design;
FIG. 2 is a rear elevational view thereof;
FIG. 3 is a left end elevational view thereof;
FIG. 4 is a right end elevational view thereof;
FIG. 5 is a top plan view thereof;
FIG. 6 is a bottom plan view thereof; and,
FIG. 7 is an environmental perspective view thereof.
The leftmost arm is shown pivoted to a deployed position in the environmental perspective view of FIG. 7. The broken line showing of saddle blankets and a horse blanket in FIG. 7 is for illustrative purposes only and forms no part of the claimed design.

1 Claim, 5 Drawing Sheets

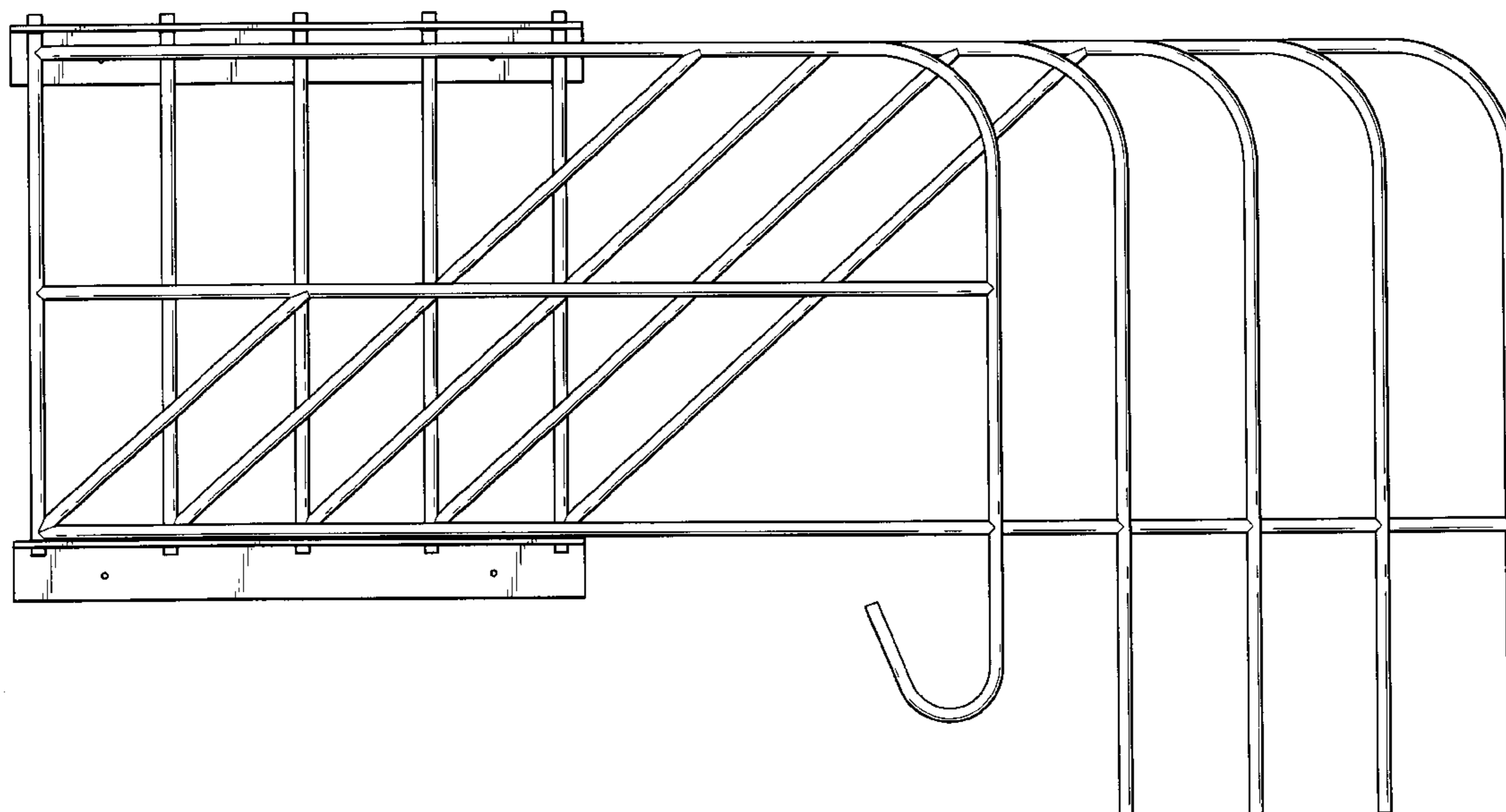

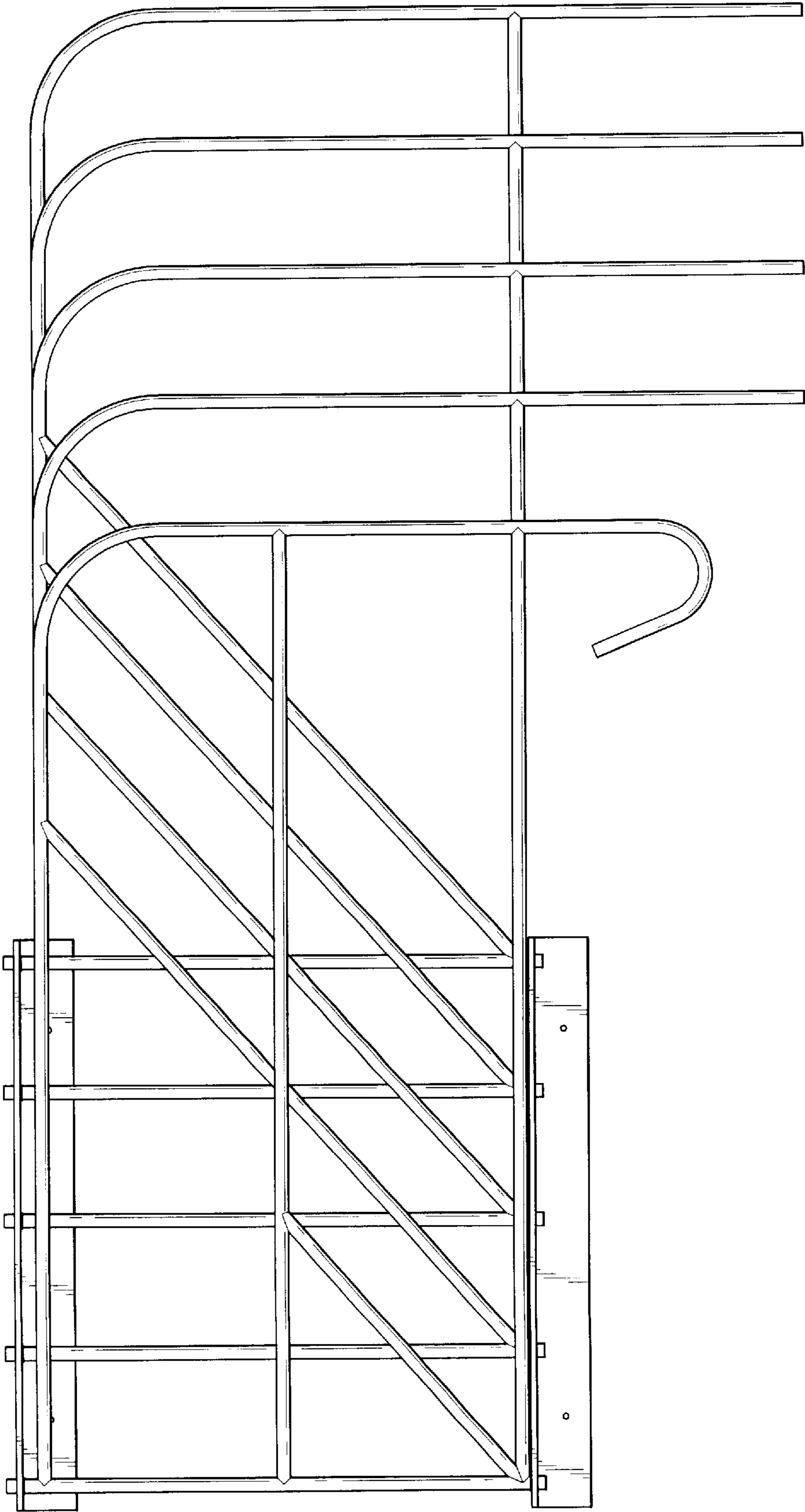

FIG. 1

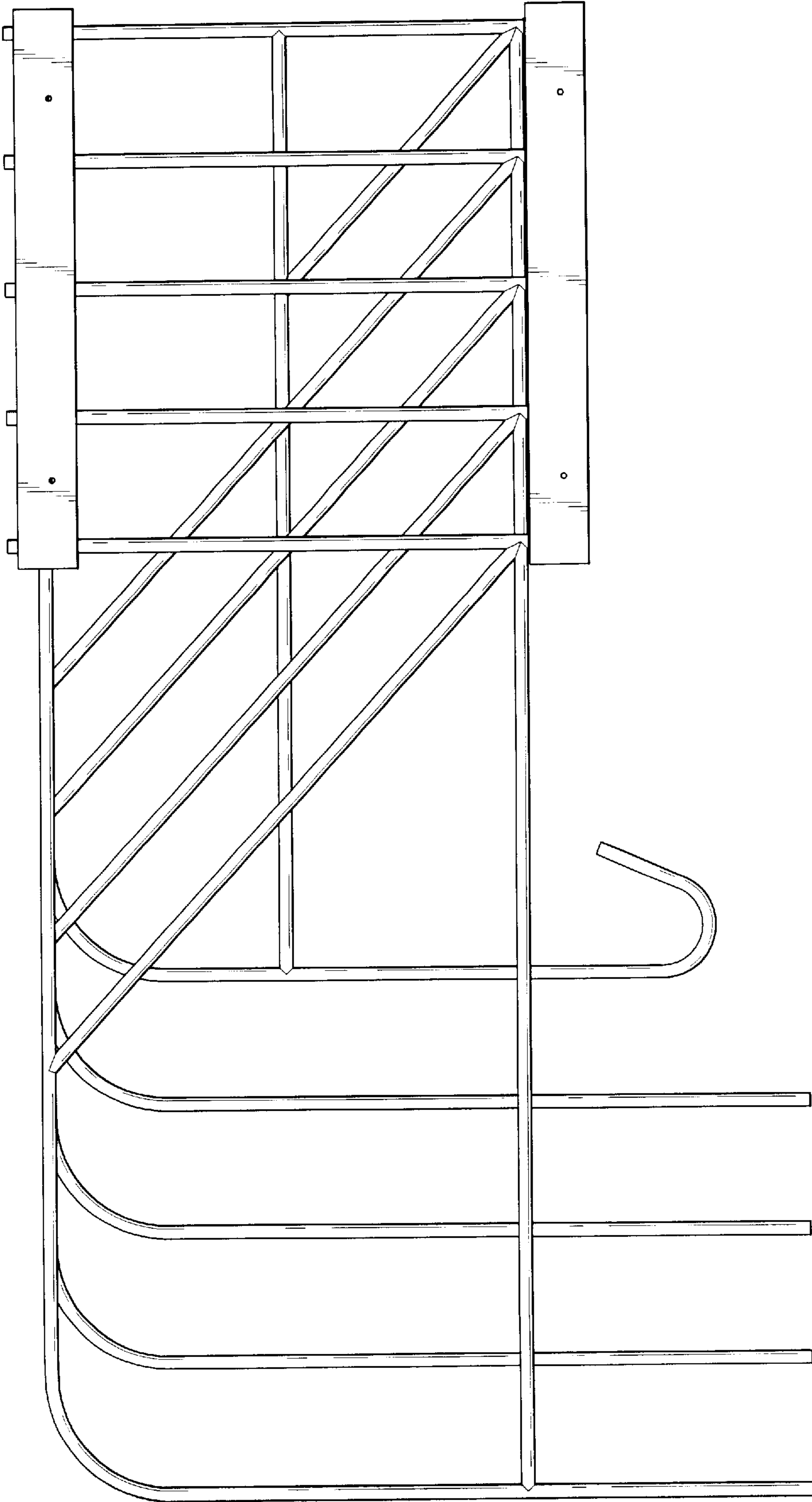

FIG. 2

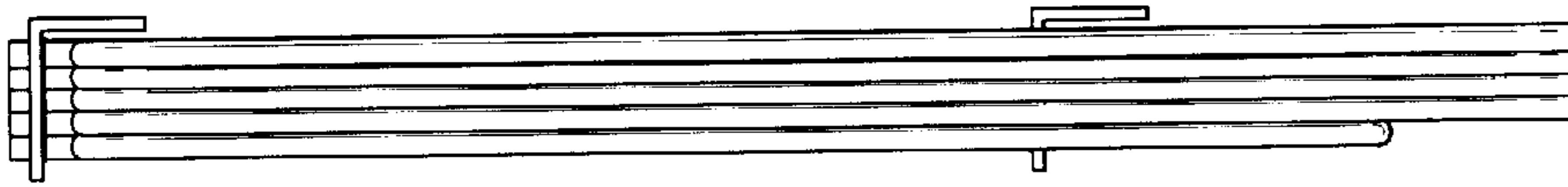

FIG. 4

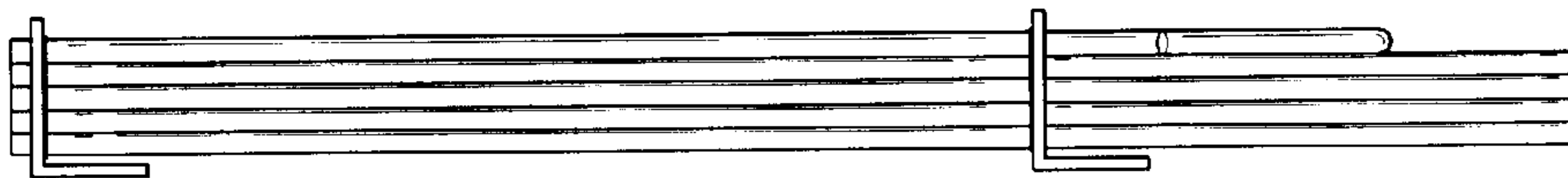

FIG. 3

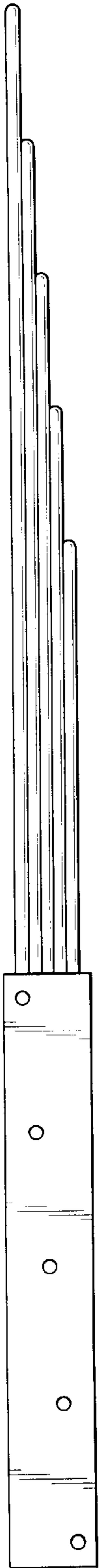

FIG. 5

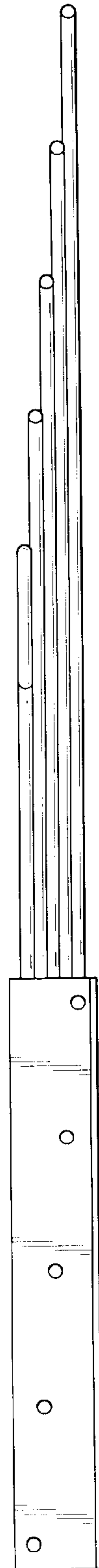

FIG. 6

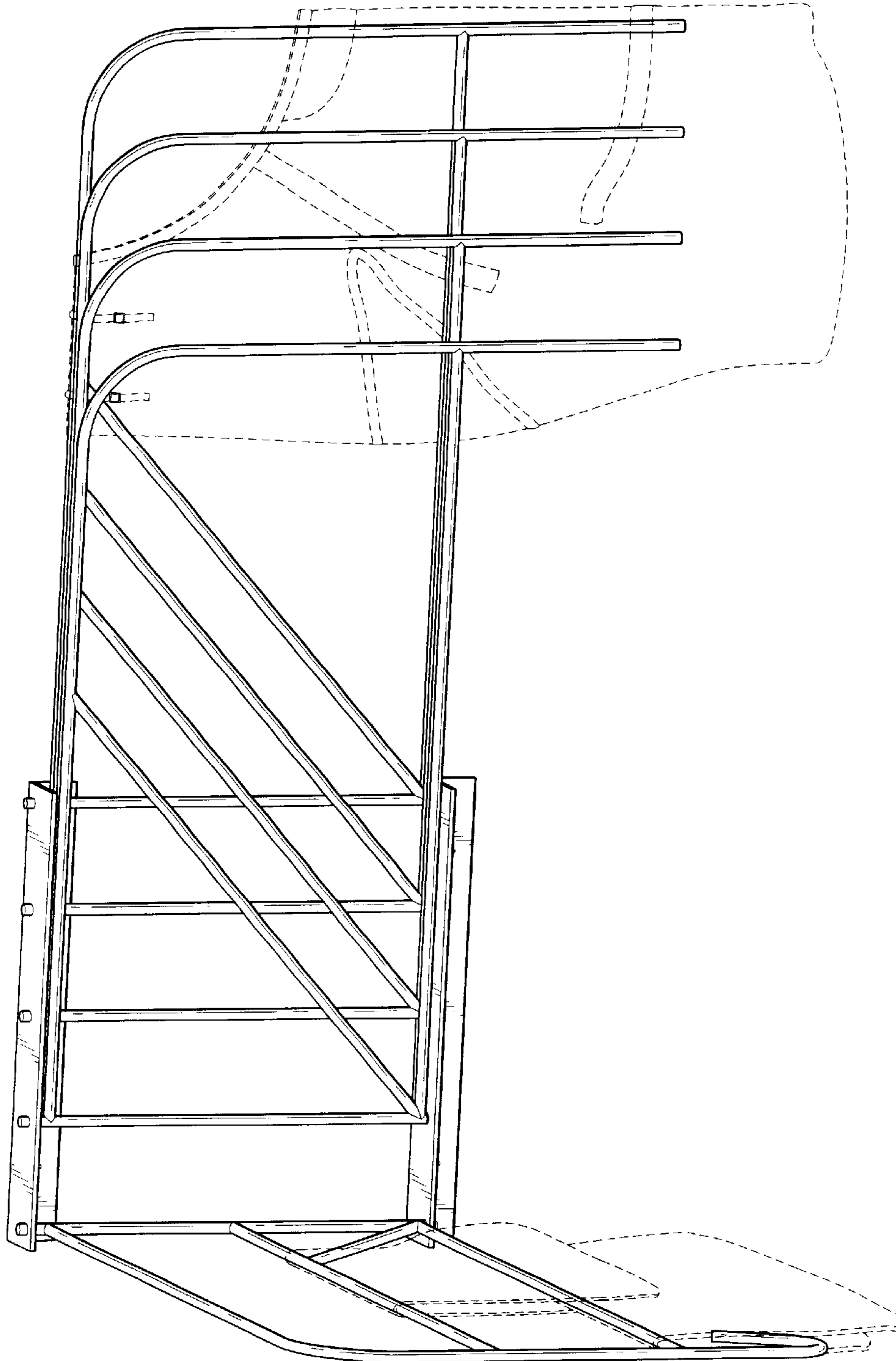

FIG. 7