

US00D521678S

(12) **United States Design Patent** (10) **Patent No.:** **US D521,678 S**
Bayer (45) **Date of Patent:** **** May 23, 2006**

(54) **LIGHT FIXTURE**

(75) Inventor: **Georg Bayer**, Plattsburgh, NY (US)

(73) Assignee: **Schonbek Worldwide Lighting, Inc.**,
Plattsburgh, NY (US)

(**) Term: **14 Years**

(21) Appl. No.: **29/221,201**

(22) Filed: **Jan. 12, 2005**

(51) **LOC (8) Cl.** **26-99**

(52) **U.S. Cl.** **D26/142; D26/154**

(58) **Field of Classification Search** D26/154,
D26/138, 113, 81, 84, 88, 61-65, 72; D11/90;
362/404-406, 457, 806; 63/26-28, 32
See application file for complete search history.

(56) **References Cited**

U.S. PATENT DOCUMENTS

D55,512 S	*	6/1920	Heller	D11/90
D56,949 S	*	1/1921	Tatler	D11/90
1,560,414 A	*	11/1925	De Haan	63/32
3,619,599 A	*	11/1971	Hermanson	362/250
3,943,353 A	*	3/1976	Tada	362/404
5,109,325 A	*	4/1992	Bayer et al.	362/433
5,116,009 A	*	5/1992	Bayer	248/303
5,144,541 A	*	9/1992	Schonbek	362/405
5,222,805 A	*	6/1993	Schonbek et al.	362/405
5,241,460 A	*	8/1993	Schonbek	362/405
5,285,364 A	*	2/1994	Bayer	362/405
5,567,046 A	*	10/1996	Lucas	362/405
5,906,430 A	*	5/1999	Bayer	362/404
5,921,668 A	*	7/1999	Bayer	362/404
6,921,186 B1	*	7/2005	Viskovich	362/404
2005/0172668 A1	*	8/2005	Bayer et al.	63/28

OTHER PUBLICATIONS

Basket Sconce with Crystal Accents. Item #92659 from Lamps Plus. Found online at lampsplus.com on Aug. 11, 2005.*

“Star Dust” by Tokujin Yoshioka from the Swarovski Crystal Palace Collection. Posted at mocoloco.com on May 9, 2005.*

James R. Modor, Strass Crystal Mini Pendant Chandelier. Item #55672 from Lamps Plus. Found online at lampsplus.com on Aug. 11, 2005.*

James R. Modor, Sapphire Mini Pendant Chandelier. Item #55666 from Lamps Plus. Found online at lampsplus.com on Aug. 11, 2005.*

WAC Catalog (c) 2004, Quick Connect Fixtures, p. 7.

WAC Catalog (c) 2004, Quick Connect Fixtures, p. 6.

WAC Catalog (c) 2004, Low Voltage Pendants, p. 104.

<http://www.lblighting.com>, Merlino, one page.

<http://www.lblighting.com>, Merlino Swivel II, one page.

* cited by examiner

Primary Examiner—Clare E Heflin

(74) *Attorney, Agent, or Firm*—Heslin Rothenberg Farley & Mesiti P.C.

(57) **CLAIM**

The ornamental design for a light fixture, as shown and described.

DESCRIPTION

This application is related to commonly assigned, concurrently filed application No. 29/221,311, application No. 29/221,312 and application No. 29/221,309, the full disclosures of which are incorporated herein by reference.

FIG. 1 is an isometric view of a first embodiment of the light fixture of the present invention;

FIG. 2 is a front elevation view thereof, the side and rear elevation views being identical thereto;

FIG. 3 is a top plan view thereof;

FIG. 4 is a bottom plan view thereof;

FIG. 5 is an isometric view of a second embodiment;

FIG. 6 is an isometric view of a third embodiment;

FIG. 7 is a front elevation view of a fourth embodiment, the rear and side elevation views being identical thereto;

FIG. 8 is a front elevation view of a fifth embodiment, the rear and side elevation views being identical thereto; and,

FIG. 9 is an isometric view of the first embodiment in a different environmental structure.

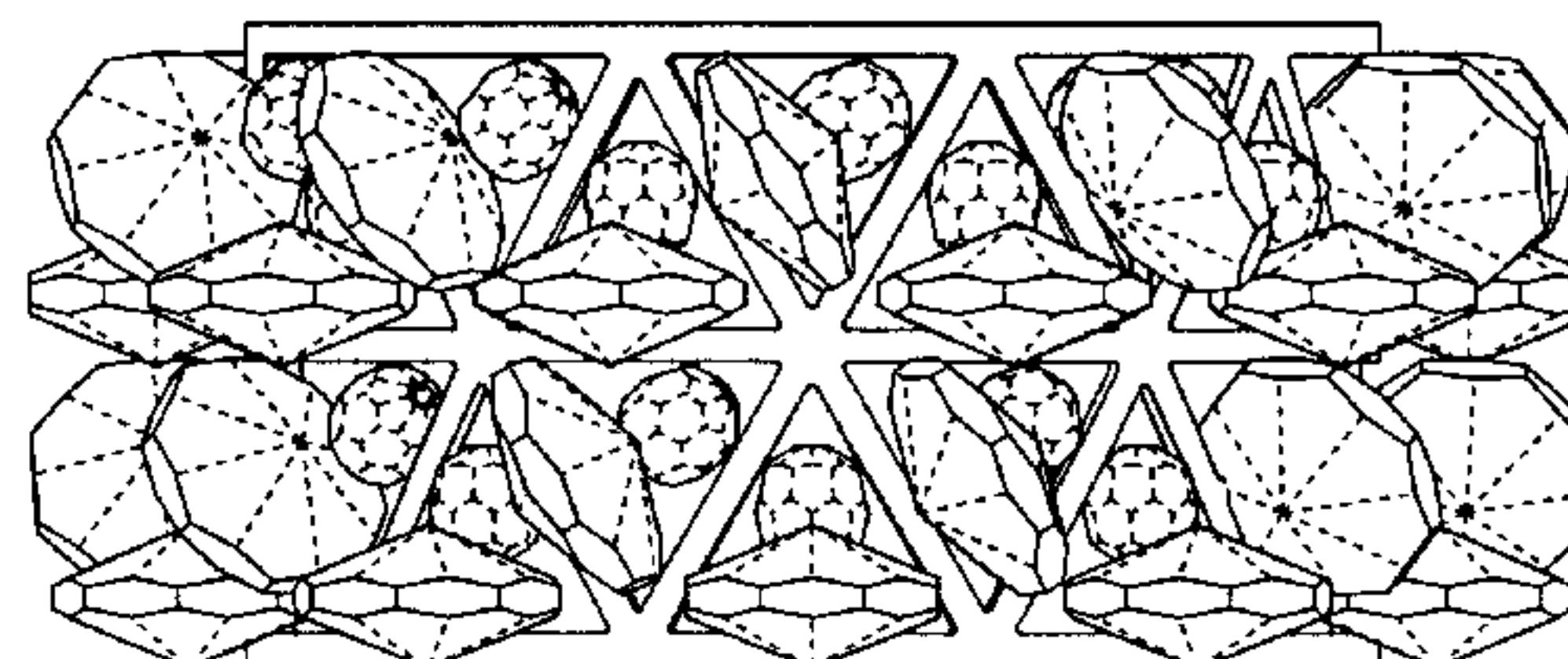
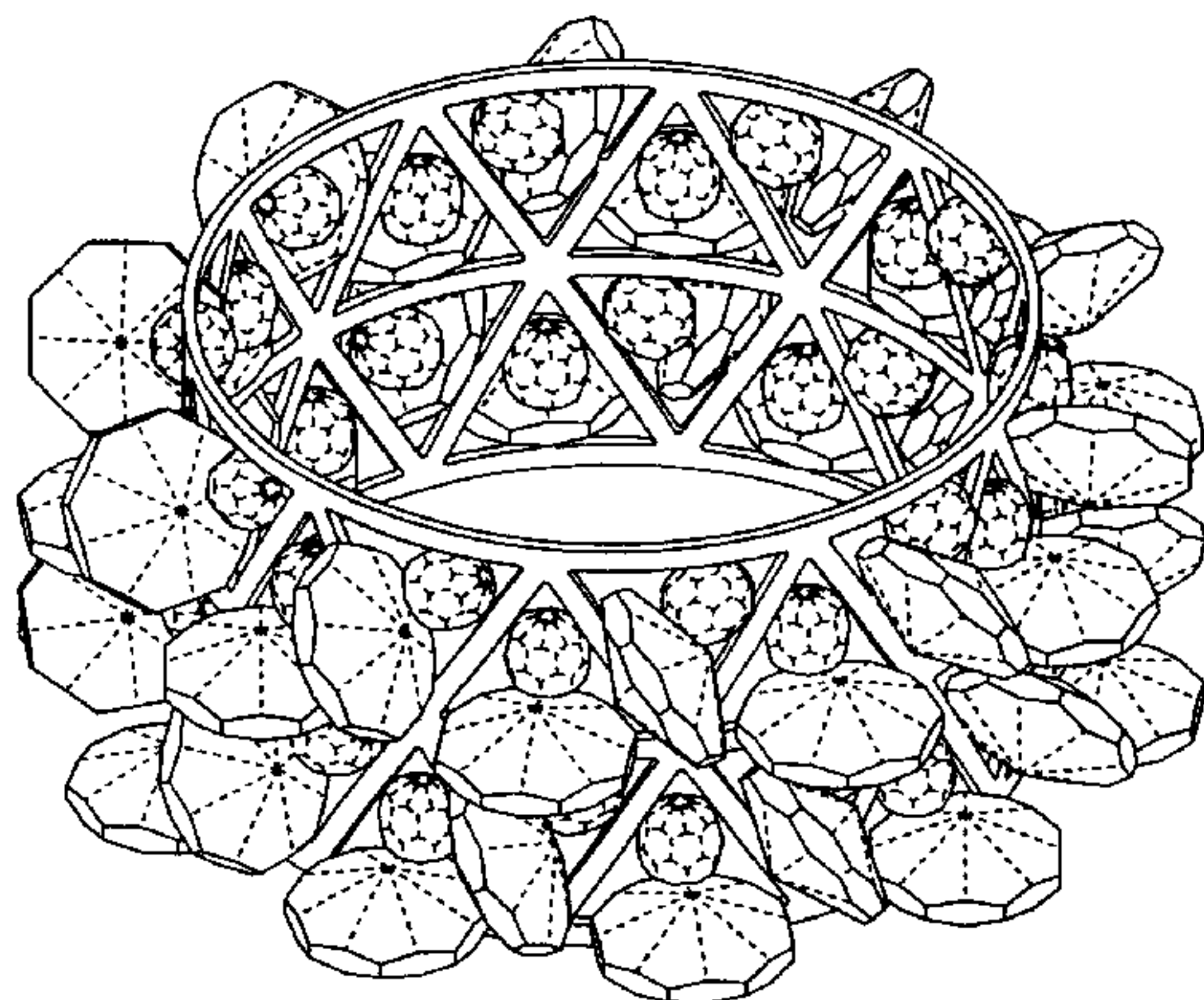

The broken line showing is for illustrative purposes only and forms no part of the claimed invention.

1 Claim, 9 Drawing Sheets

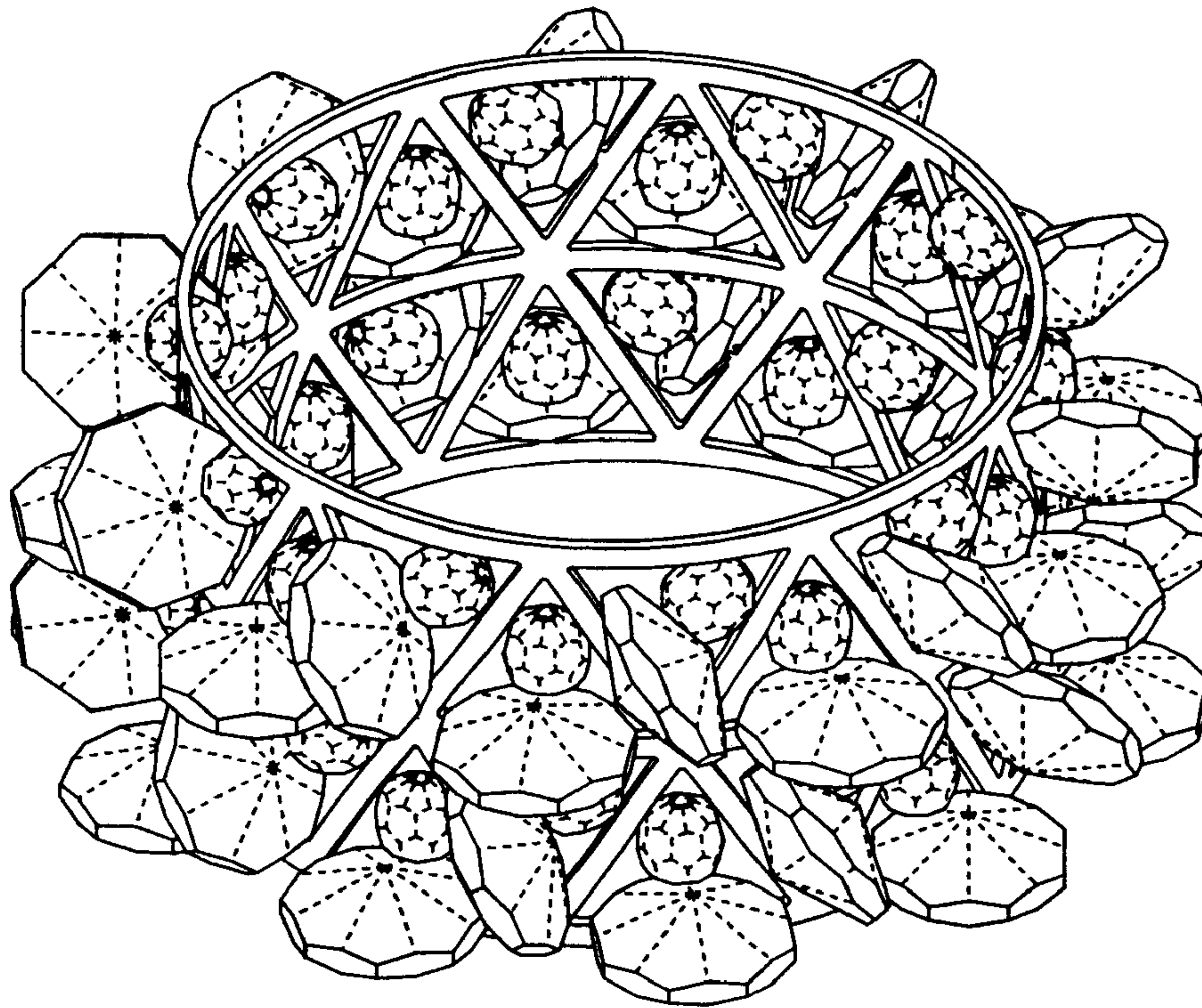

FIG. 1

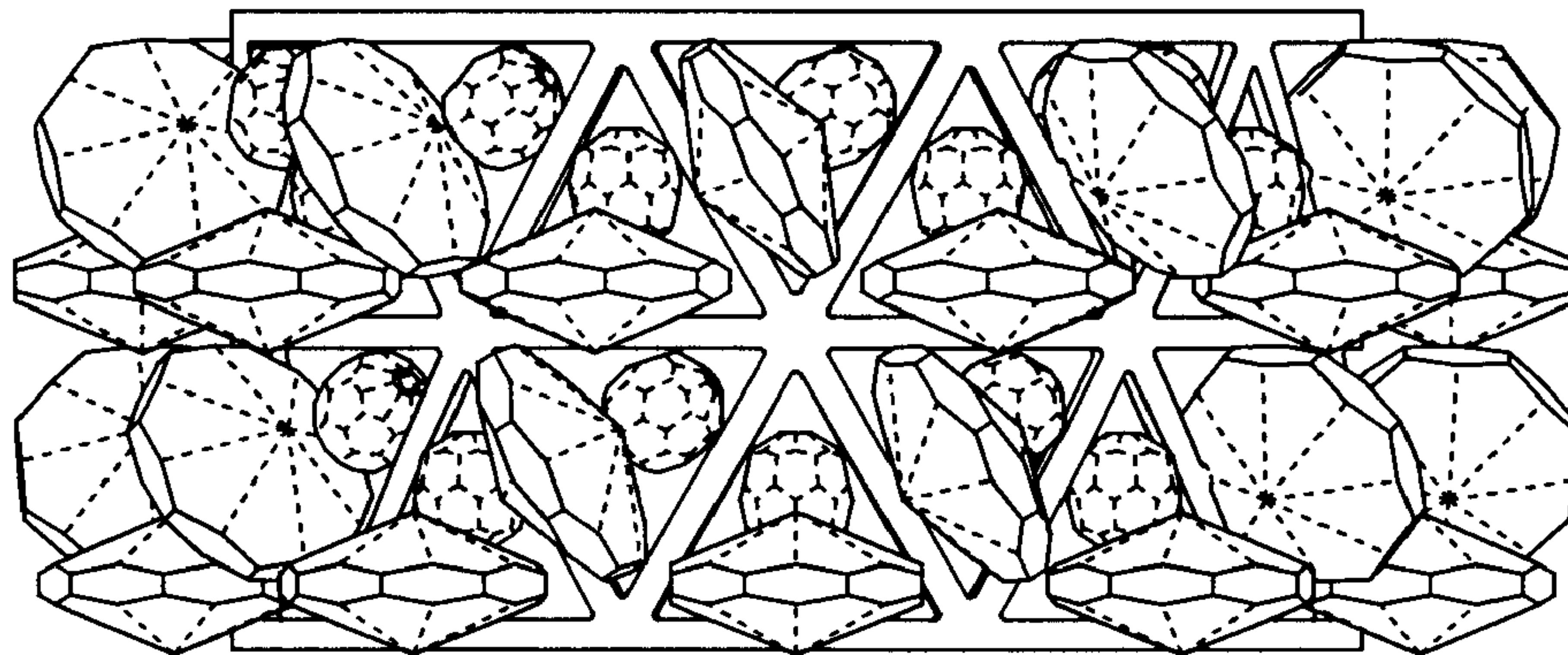

FIG. 2

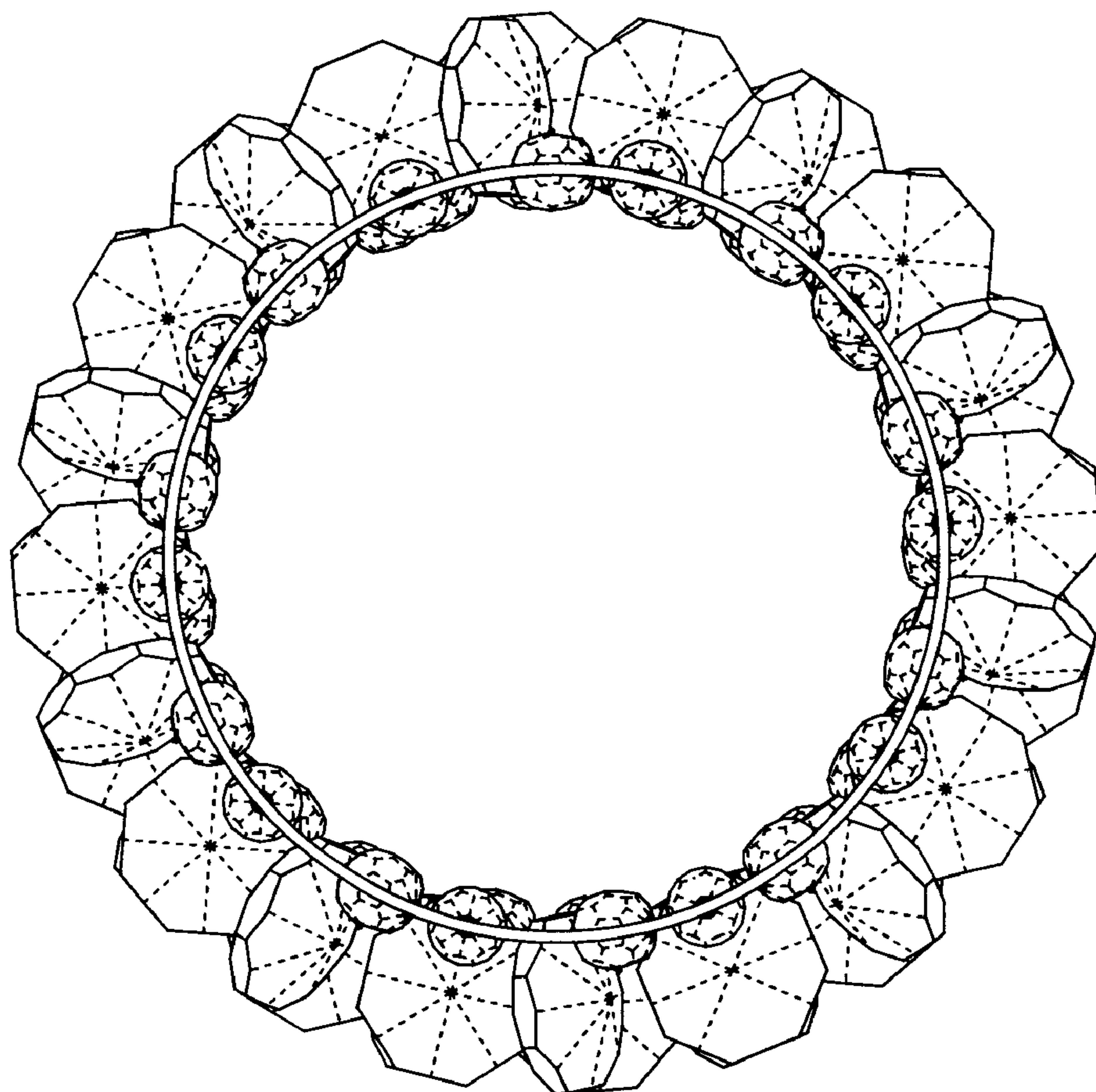

FIG. 3

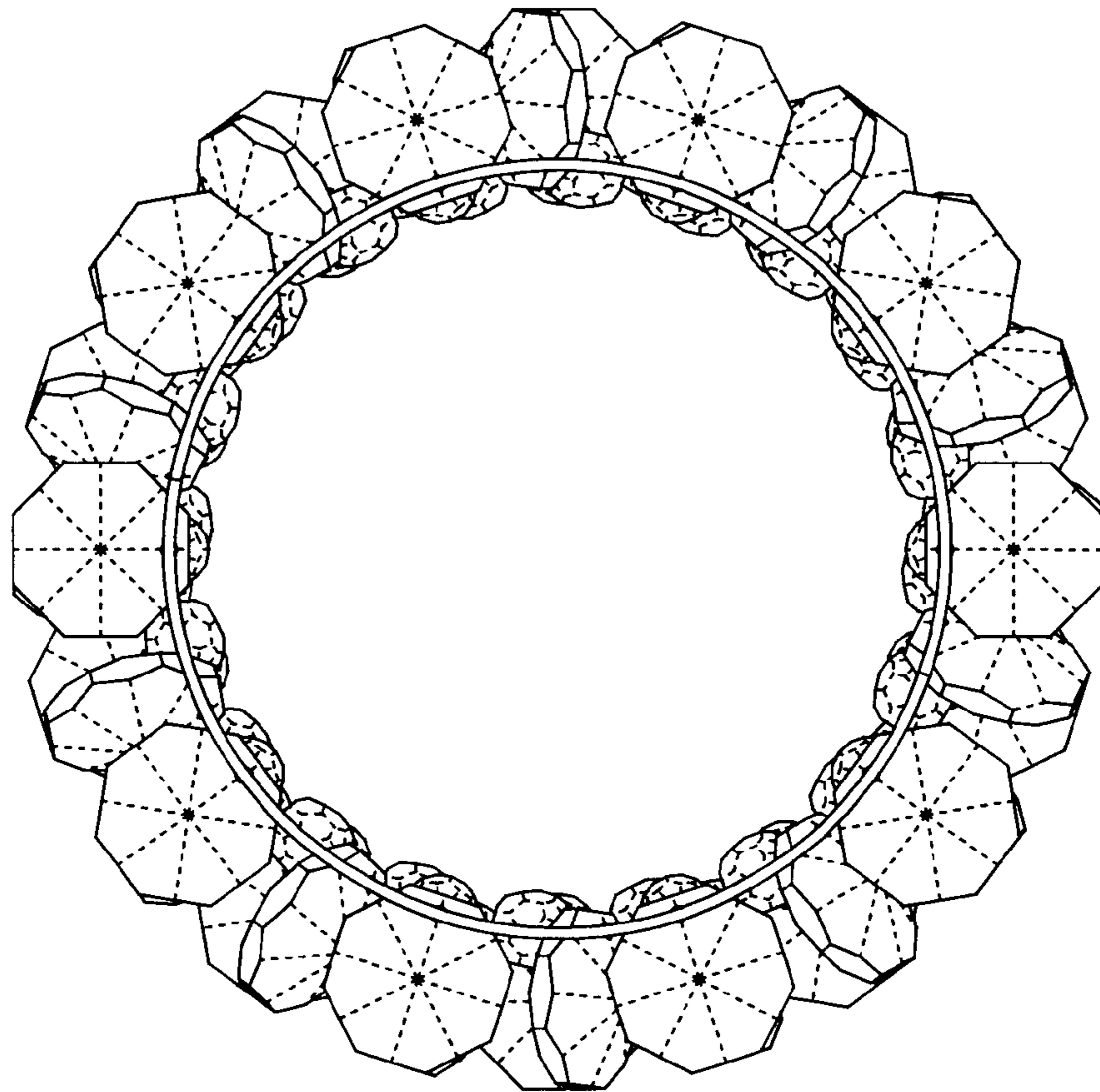

FIG. 4

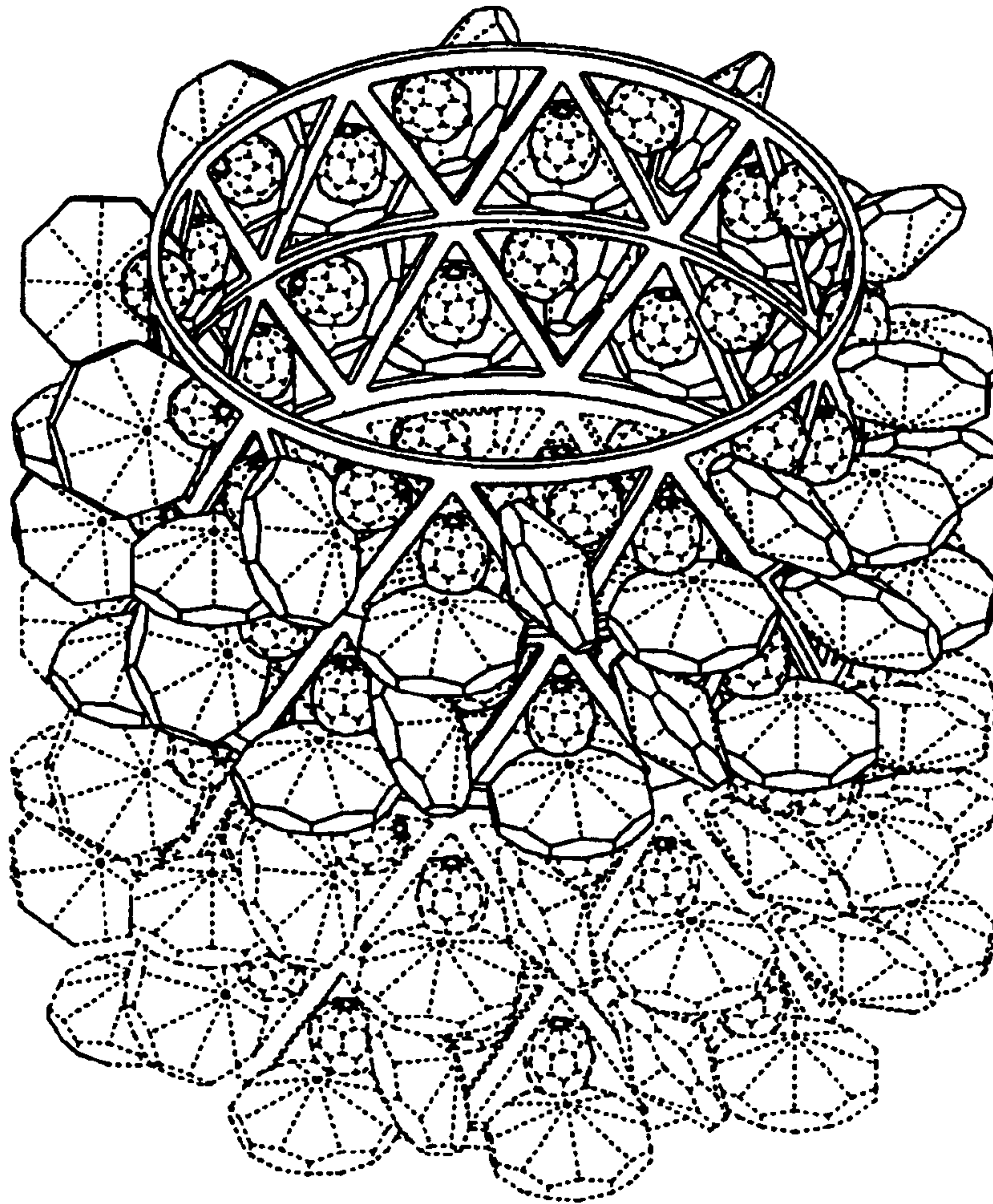

FIG. 5

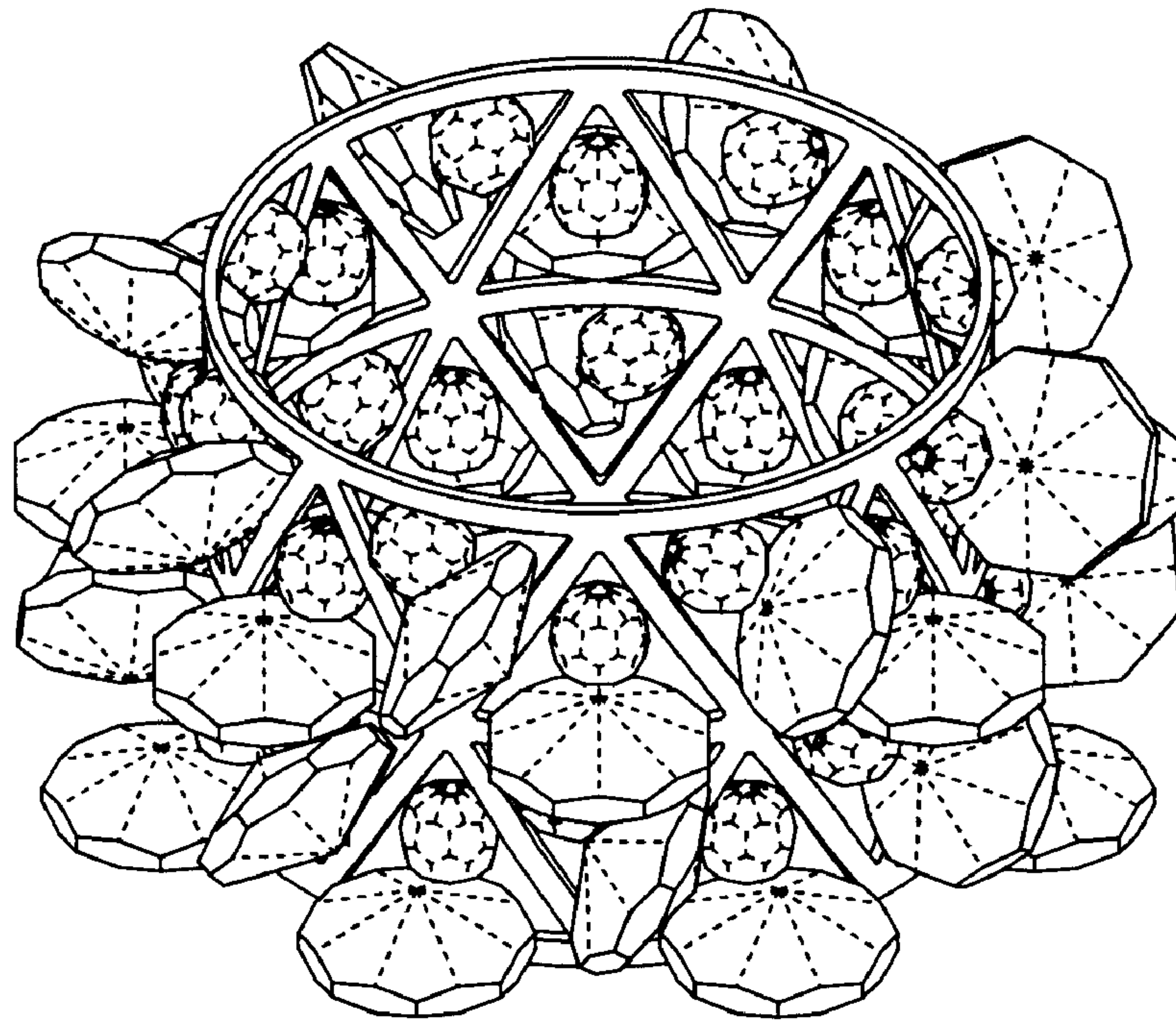

FIG. 6

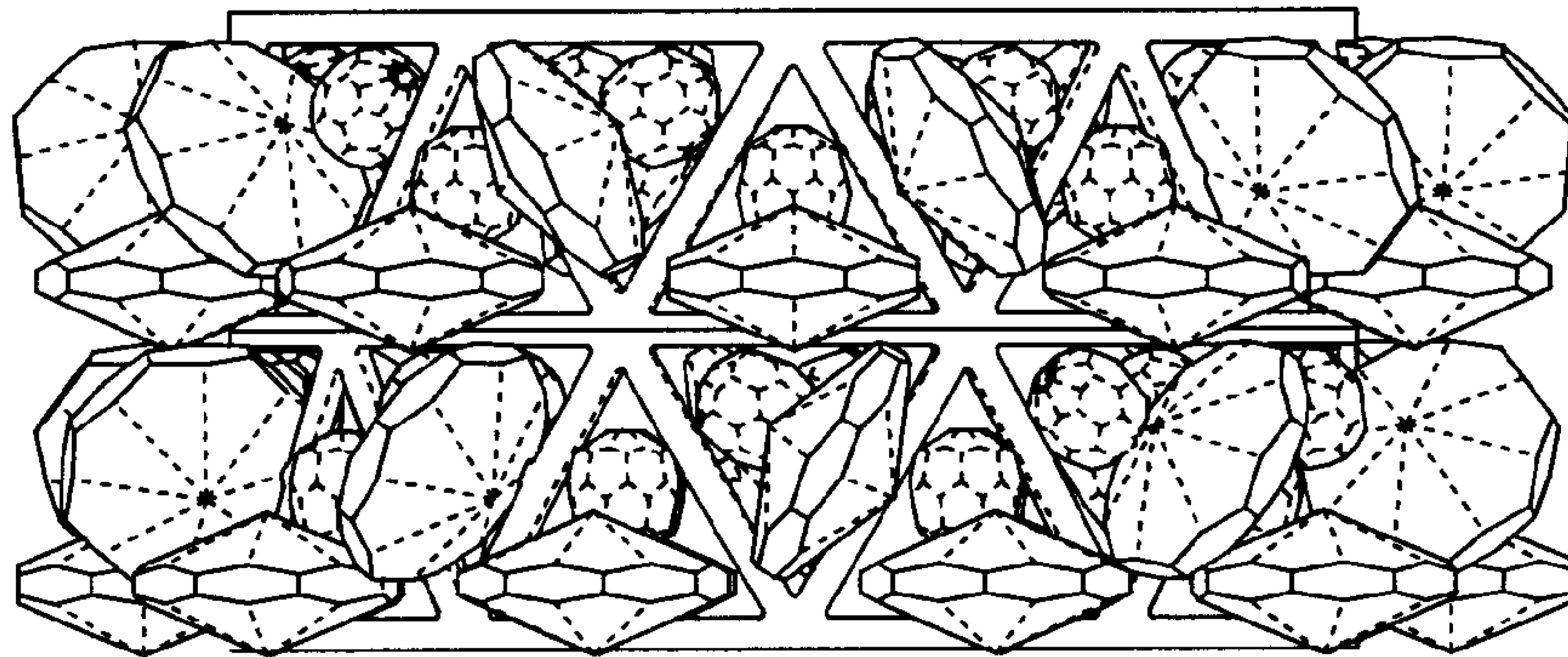

FIG. 7

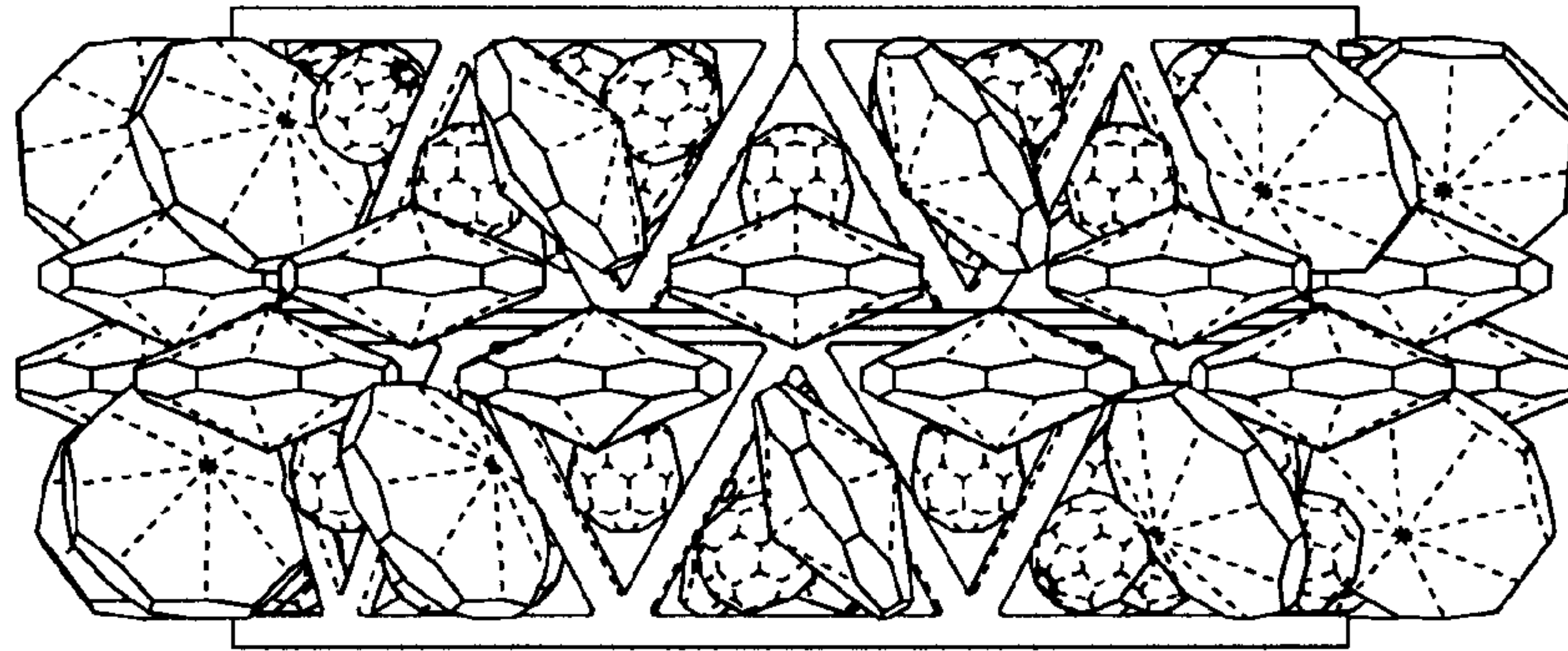

FIG. 8

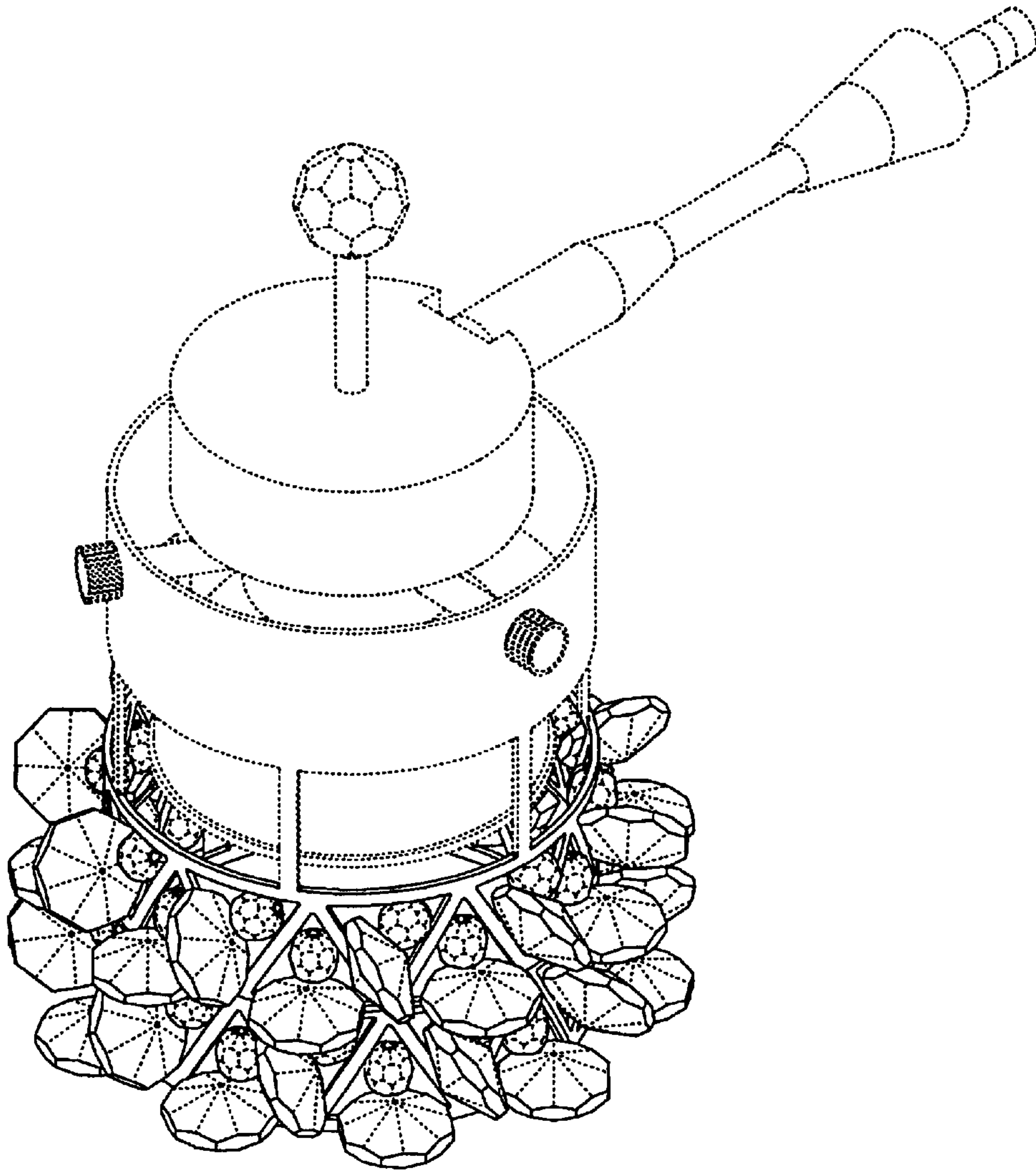

FIG. 9