



US00D521575S

(12) **United States Design Patent**
Gershwin

(10) **Patent No.:** **US D521,575 S**

(45) **Date of Patent:** **** May 23, 2006**

(54) **DOLL**

(76) Inventor: **Nancy Z. Gershwin**, 10350 Wilshire Blvd., Penthouse 1, Los Angeles, CA (US) 90024

(**) Term: **14 Years**

(21) Appl. No.: **29/239,642**

(22) Filed: **Sep. 30, 2005**

(51) **LOC (8) Cl.** **21-01**

(52) **U.S. Cl.** **D21/630; D21/631**

(58) **Field of Classification Search** D21/576, D21/594, 621, 622, 623, 627, 630, 631, 634, D21/639; D11/160; 446/268, 369-375, 376-384, 446/325, 226, 297-303, 330
See application file for complete search history.

(56) **References Cited**

U.S. PATENT DOCUMENTS

D150,006 S	*	6/1948	Fung	D21/577
D159,937 S	*	8/1950	Stoddard	D21/577
D166,016 S	*	2/1952	Auzin	D21/594
D246,740 S	*	12/1977	Lohr	D21/630
D247,129 S	*	1/1978	Fimreite et al.	D21/630

D250,052 S	*	10/1978	Salt et al.	D21/630
D342,557 S	*	12/1993	Frick	D21/630
D367,507 S	*	2/1996	Lederman	D21/631
D394,479 S	*	5/1998	Burton et al.	D21/630
D420,065 S	*	2/2000	Ashbridge	D21/627
D482,744 S	*	11/2003	Krueger	D21/621

* cited by examiner

Primary Examiner—Lucy Lieberman

(74) *Attorney, Agent, or Firm*—Blakely, Sokoloff, Taylor & Zafman LLP

(57) **CLAIM**

The ornamental design for a doll, as shown and described.

DESCRIPTION

FIG. 1 is a top, front and right side perspective view of a doll showing my new design.

FIG. 2 is a front view of the doll.

FIG. 3 is a rear view of the doll.

FIG. 4 is a right side elevation of the doll.

FIG. 5 is a left side elevation of the doll.

FIG. 6 is a top view of the doll; and,

FIG. 7 is a bottom view of the doll.

1 Claim, 6 Drawing Sheets

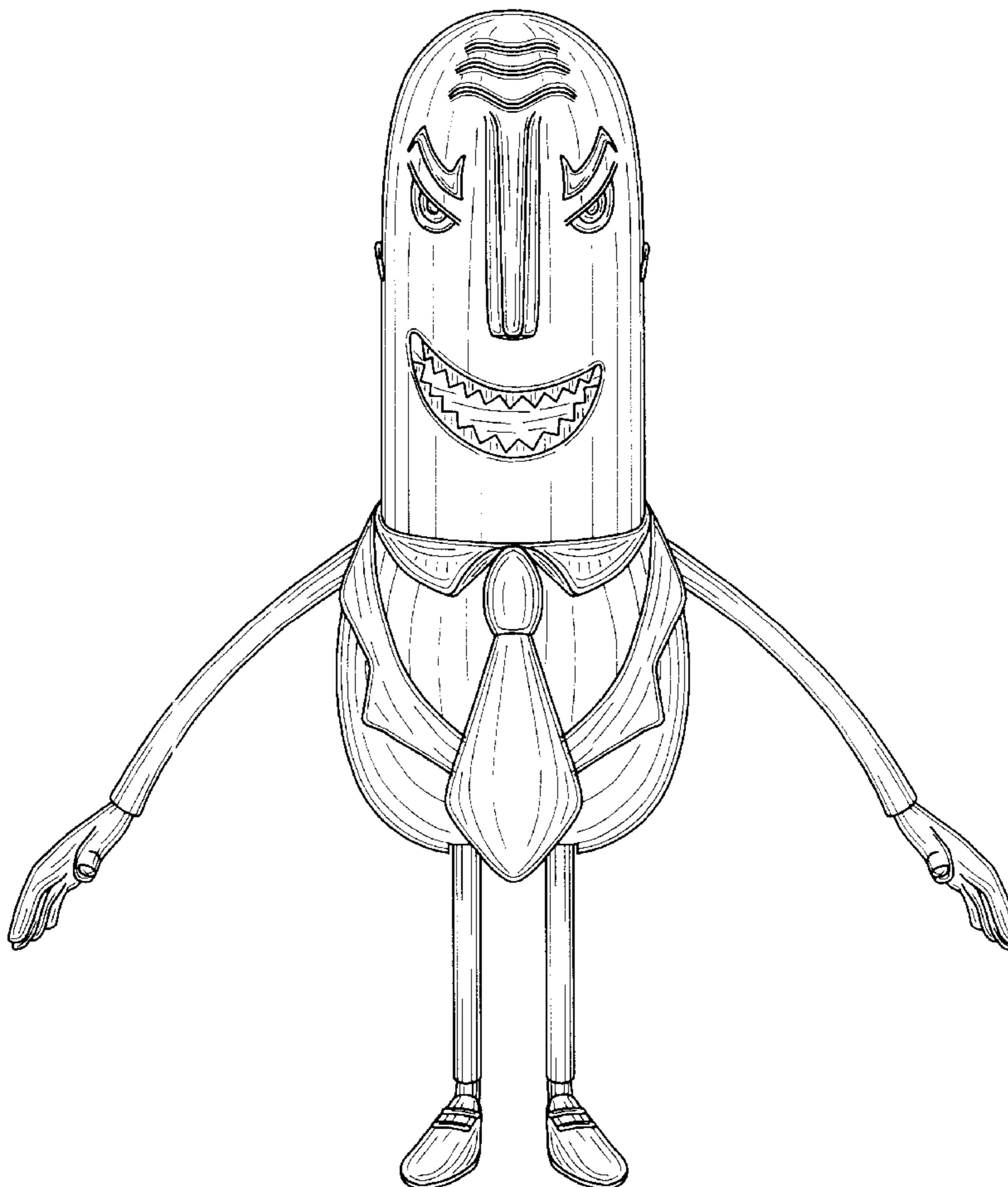

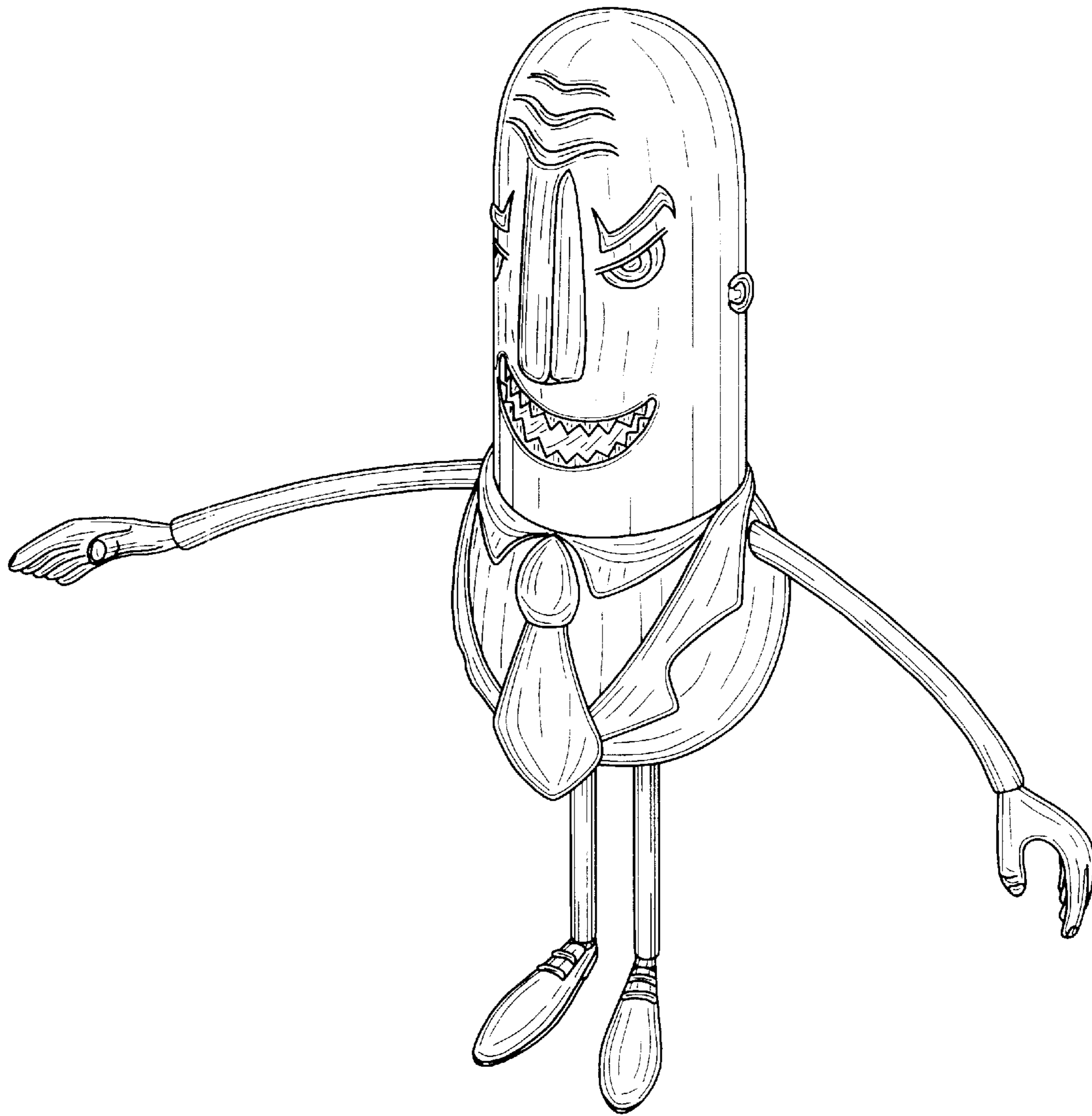

FIG. 1

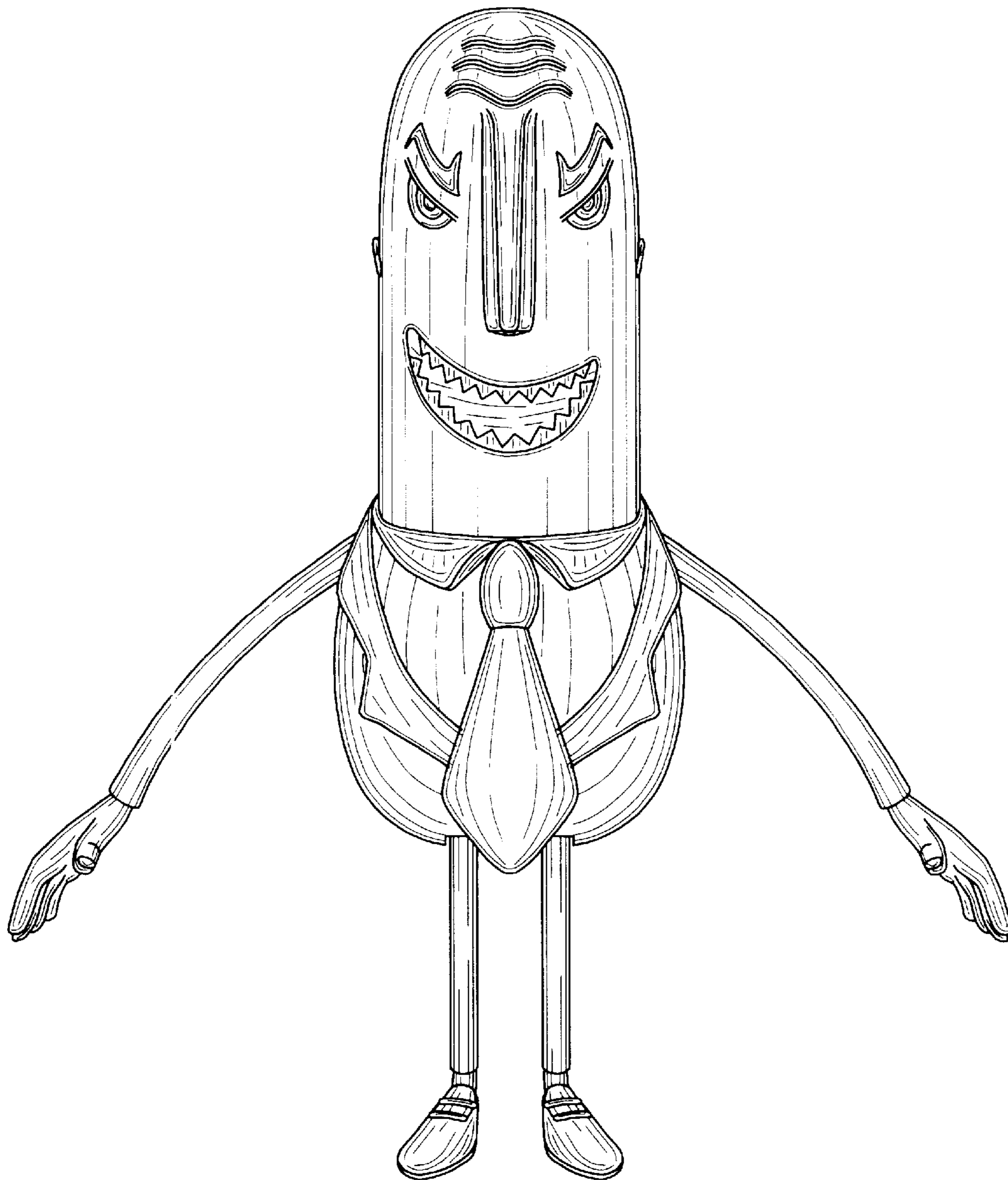

FIG. 2

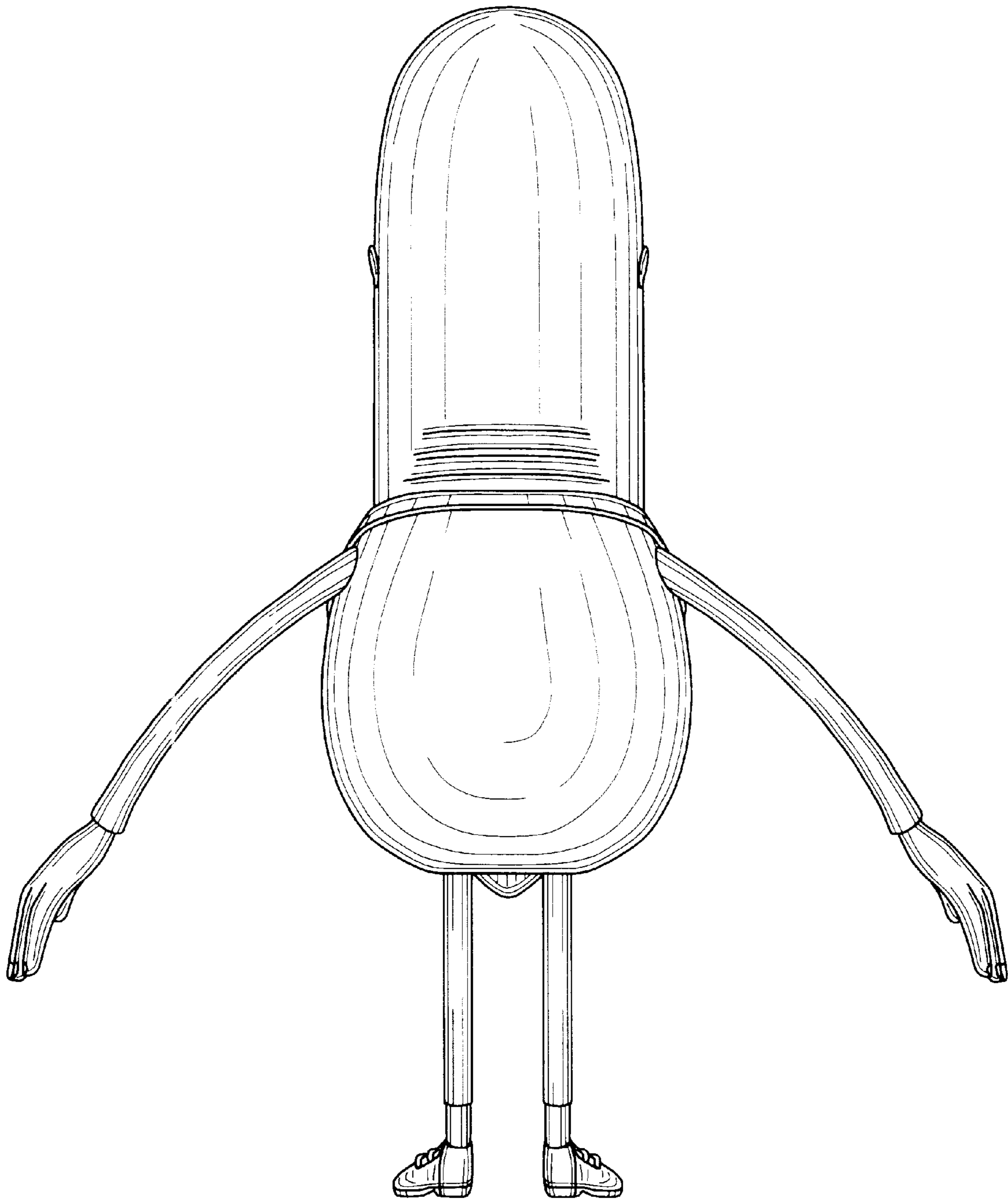

FIG. 3

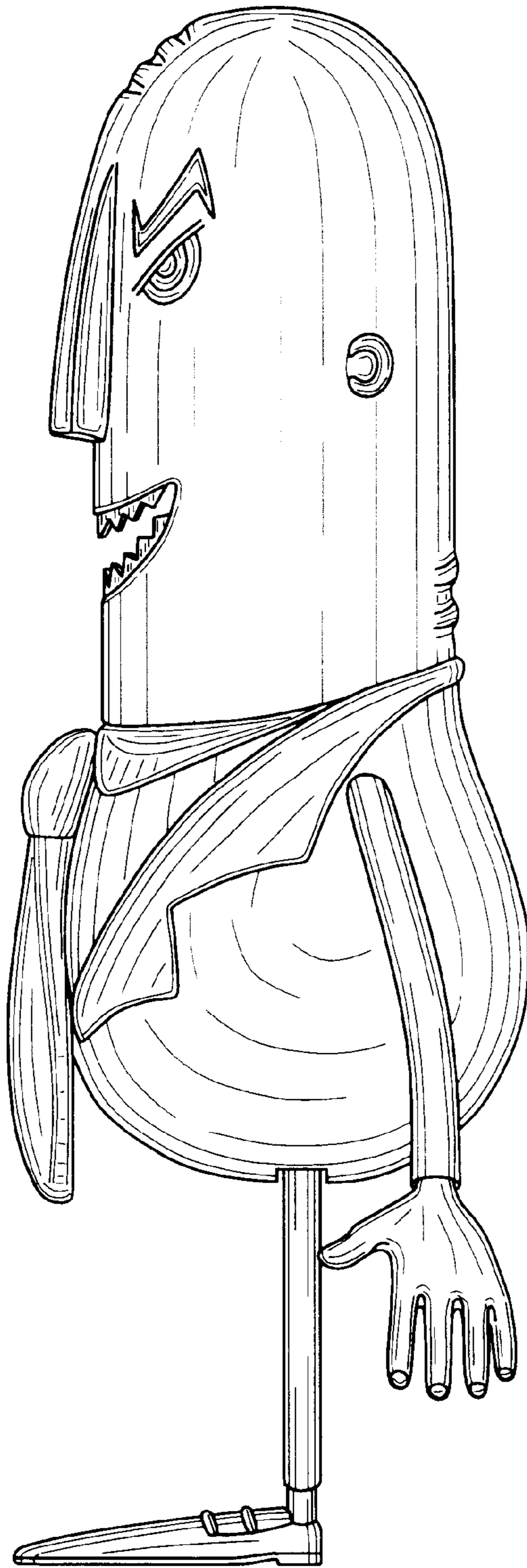

FIG. 4

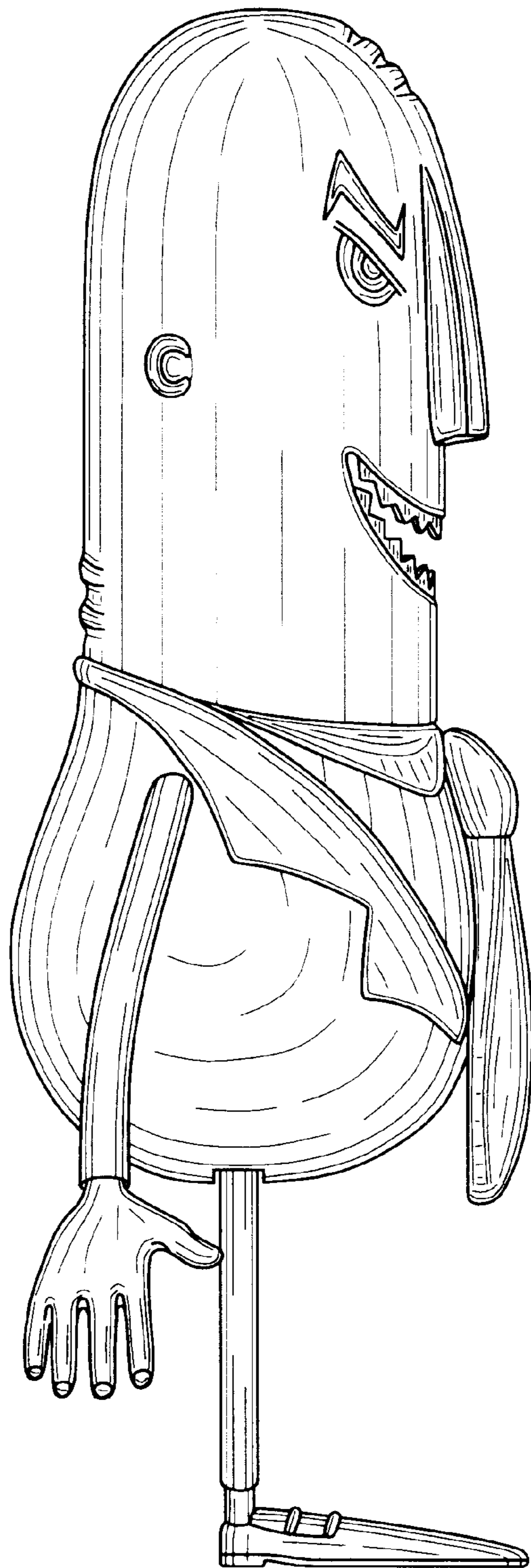

FIG. 5

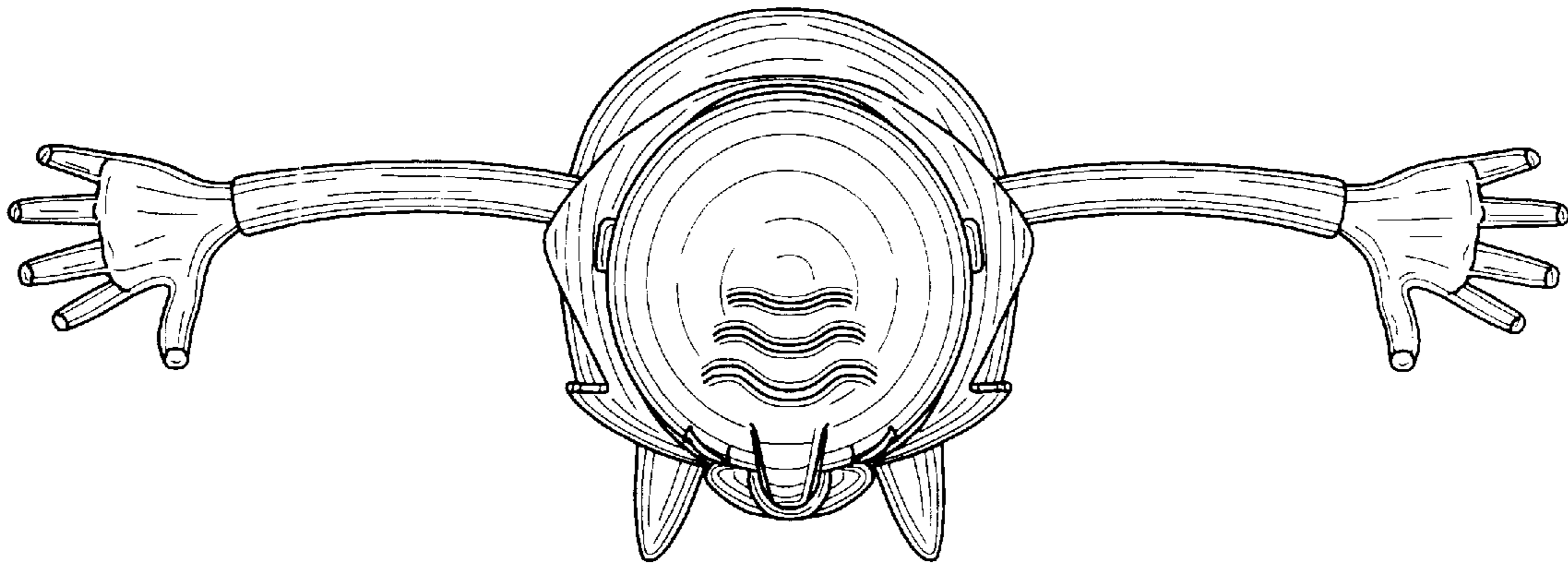

FIG. 6

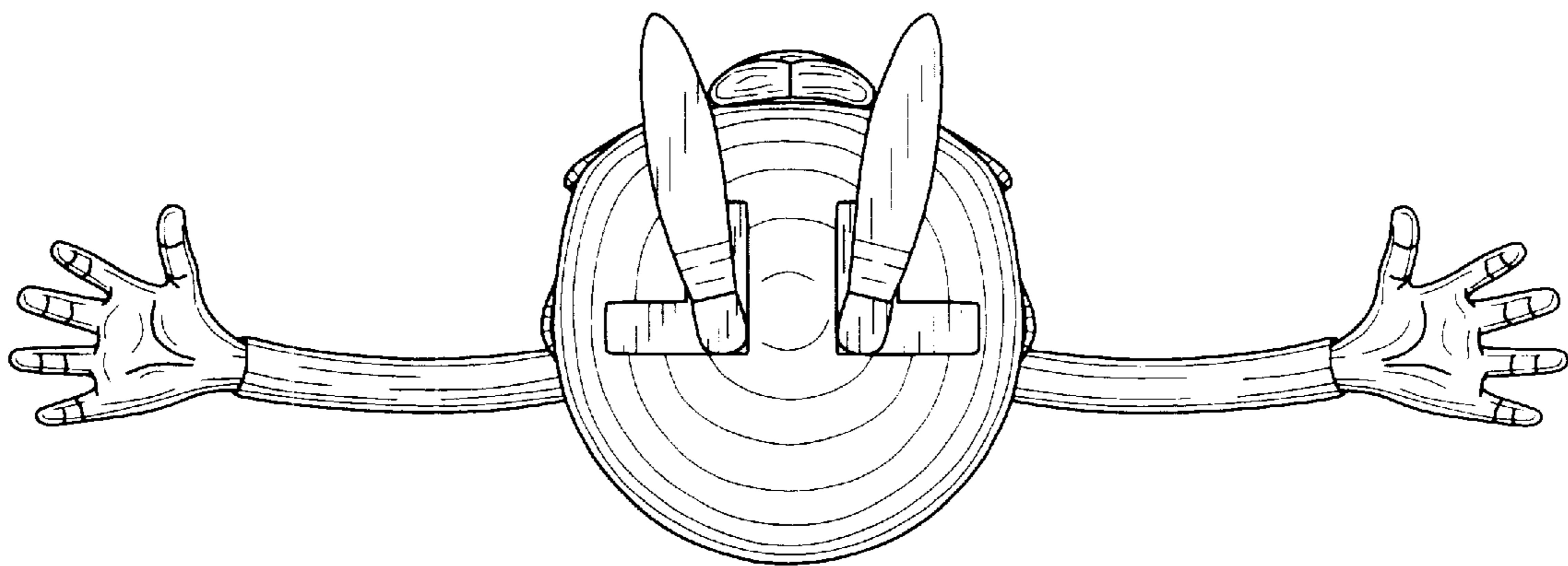

FIG. 7