



US00D521474S

(12) **United States Design Patent**
Hoehn et al.

(10) **Patent No.:** **US D521,474 S**

(45) **Date of Patent:** **** May 23, 2006**

(54) **TELEVISION SET**

(75) Inventors: **Holger Hoehn**, Taipei (TW); **Reinier Bloem**, Taipei (TW)

(73) Assignee: **Hannspree Inc.**, Taipei (TW)

(**) Term: **14 Years**

(21) Appl. No.: **29/230,022**

(22) Filed: **May 17, 2005**

(30) **Foreign Application Priority Data**

Dec. 8, 2004 (TW) 93307436

(51) **LOC (8) Cl.** **14-03**

(52) **U.S. Cl.** **D14/132; D14/129; D14/126**

(58) **Field of Classification Search** D14/125-134,
D14/239, 371, 136, 374-377; 312/7.2; 348/836,
348/838, 180, 184, 325, 739; 341/12; 248/917-924,
248/465; 345/104, 133, 156, 168, 87, 173;
720/605, 669, 600, 655; 369/99, 197; 455/344-347
See application file for complete search history.

(56) **References Cited**

U.S. PATENT DOCUMENTS

D209,710 S * 12/1967 Bruce D14/133
D424,534 S * 5/2000 Priestman et al. D14/374

6,227,966 B1 * 5/2001 Yokoi 446/175
D474,468 S * 5/2003 Zuege et al. D21/515
D475,707 S * 6/2003 Zuege et al. D21/515
D476,654 S * 7/2003 Zuege et al. D14/371
D476,991 S * 7/2003 Zuege et al. D14/371
D496,660 S * 9/2004 Liu D14/371

* cited by examiner

Primary Examiner—Raphael Barkai

(74) *Attorney, Agent, or Firm*—Rosenberg, Klein & Lee

(57) **CLAIM**

The ornamental design for a television set, as shown and described.

DESCRIPTION

FIG. 1 is a perspective view of a television set showing our new design;

FIG. 2 is a front view thereof;

FIG. 3 is a rear view thereof;

FIG. 4 is a left view thereof;

FIG. 5 is a right view thereof;

FIG. 6 is a top view thereof;

FIG. 7 is a bottom view thereof; and,

FIG. 8 is a perspective view of the television set when the protective cover is closed.

1 Claim, 6 Drawing Sheets

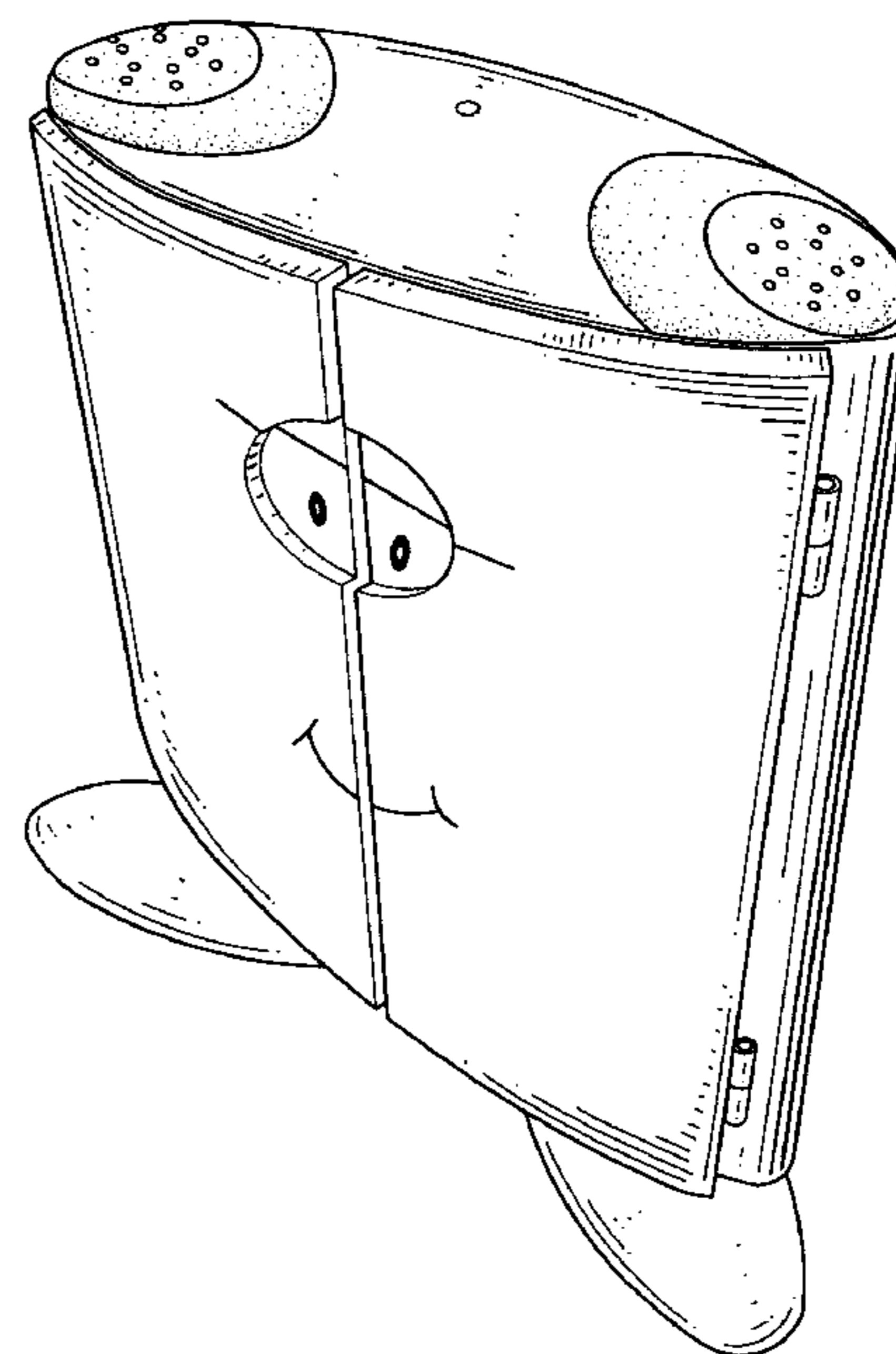
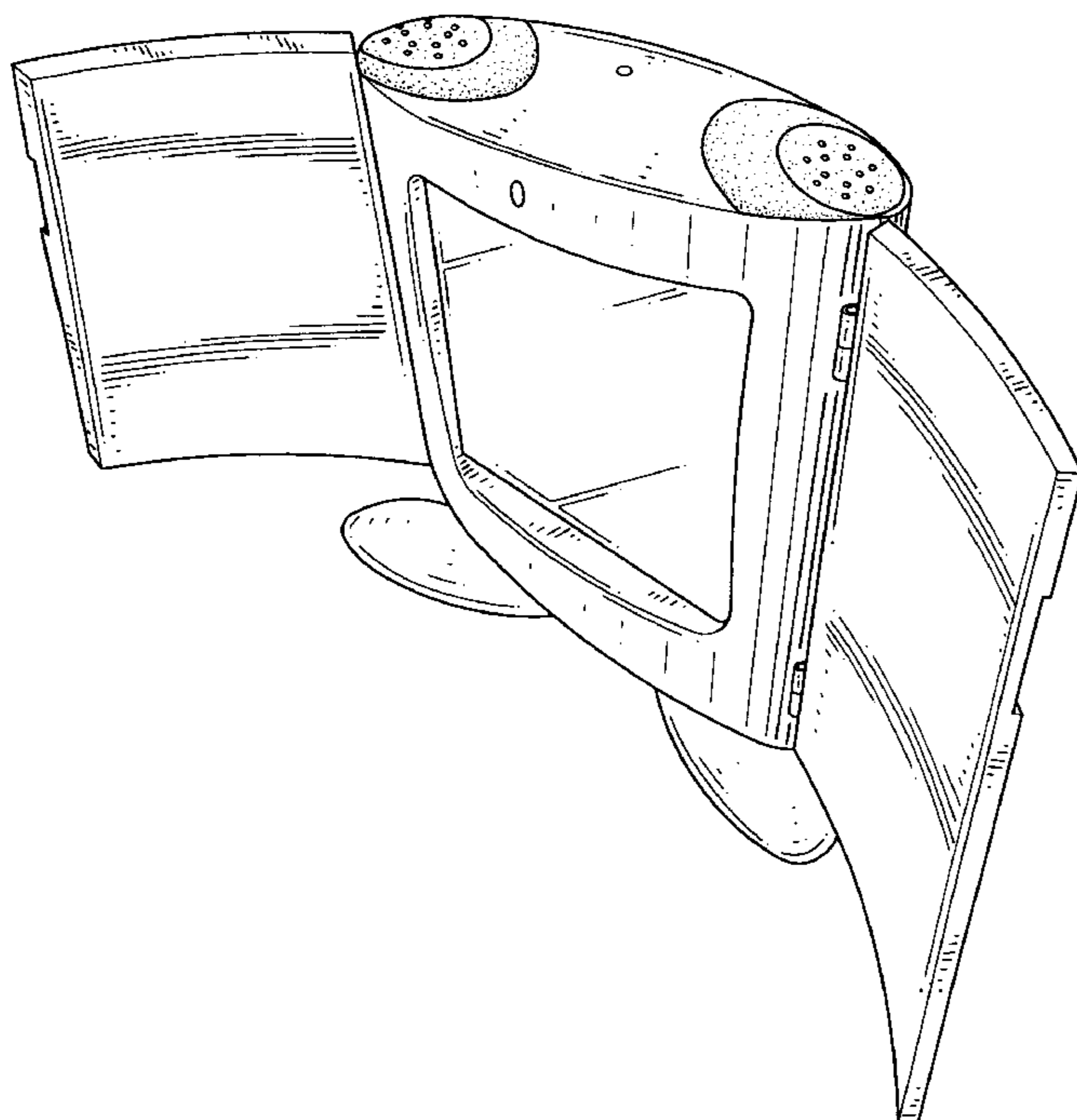

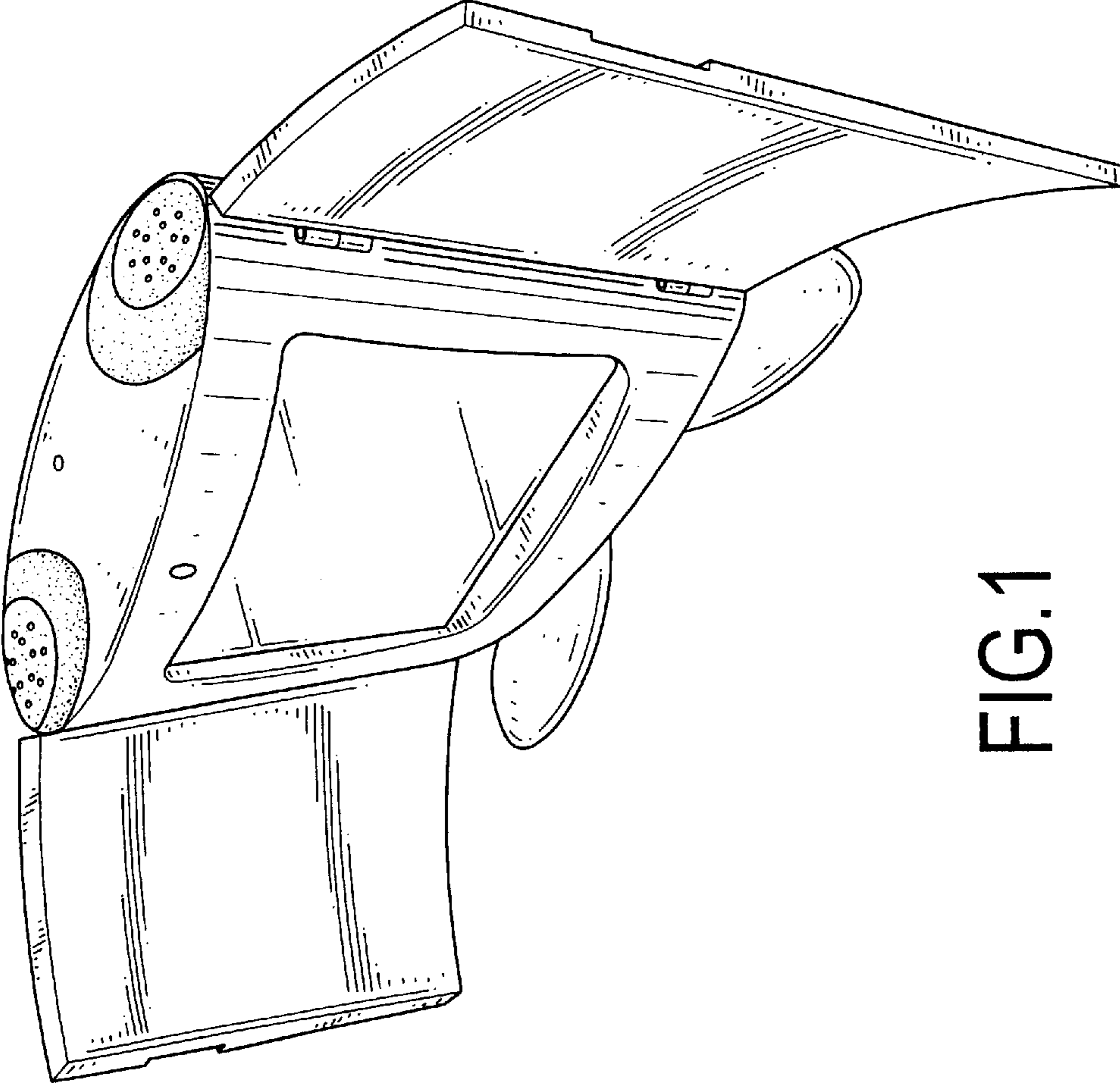

FIG.1

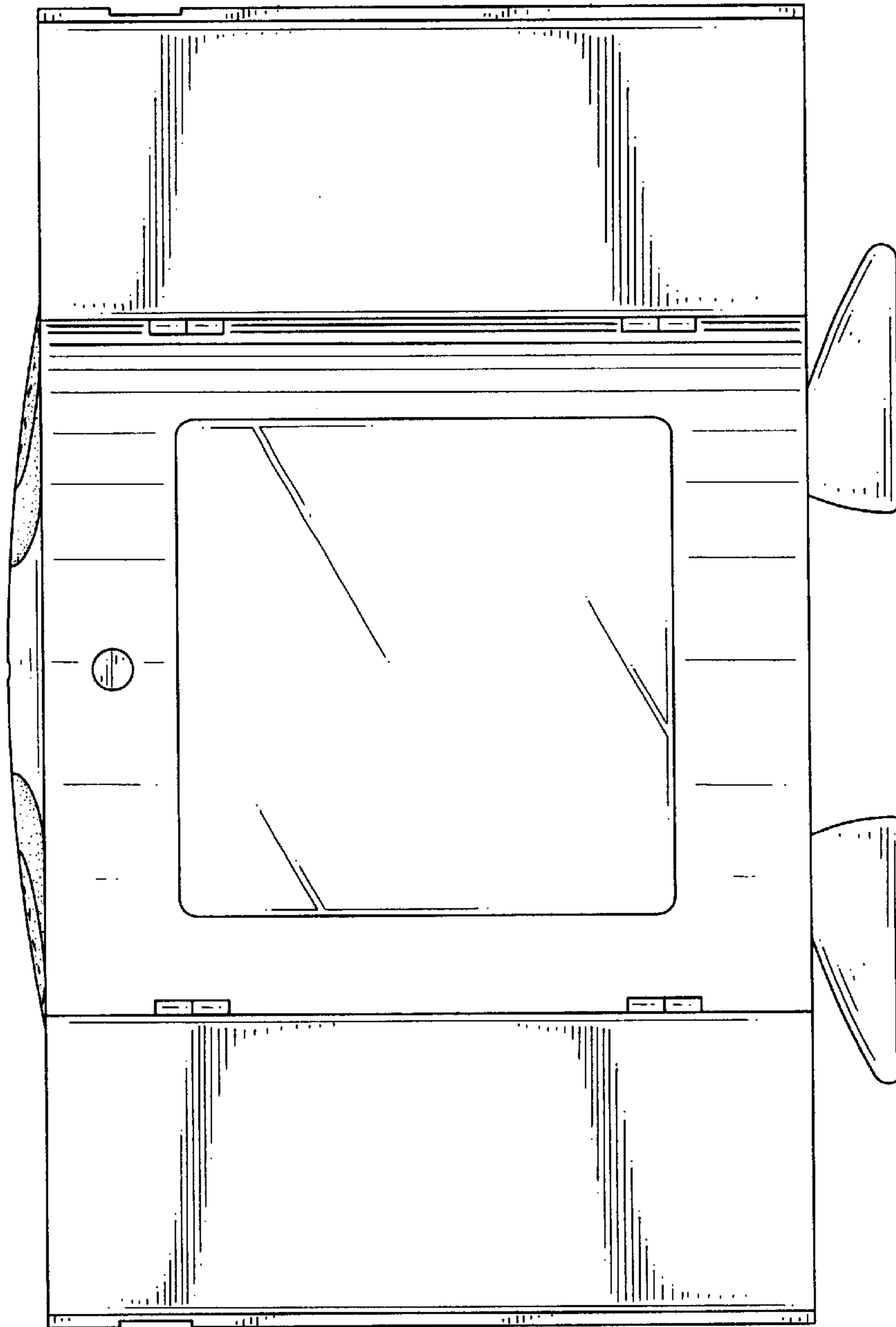

FIG.2

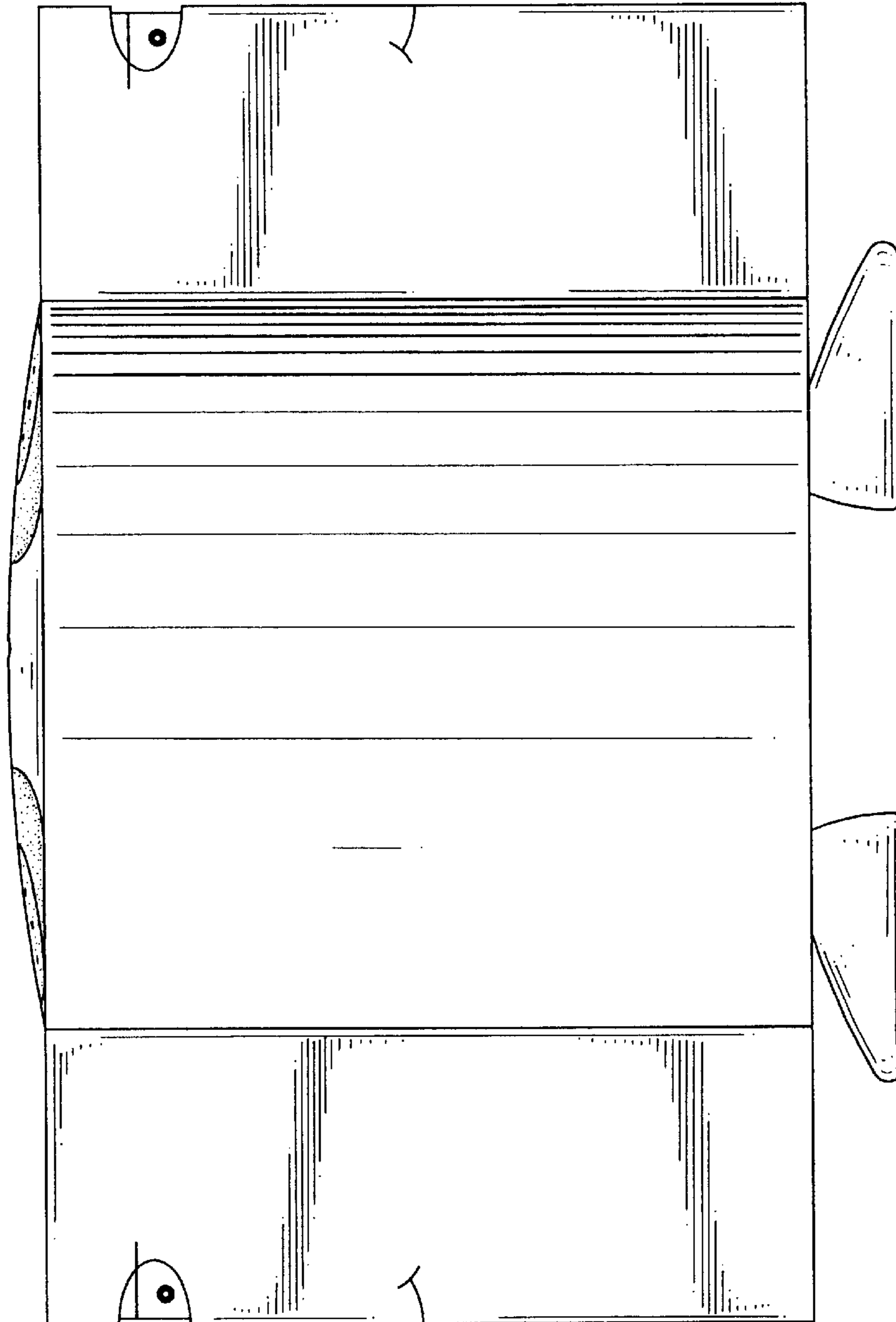

FIG.3

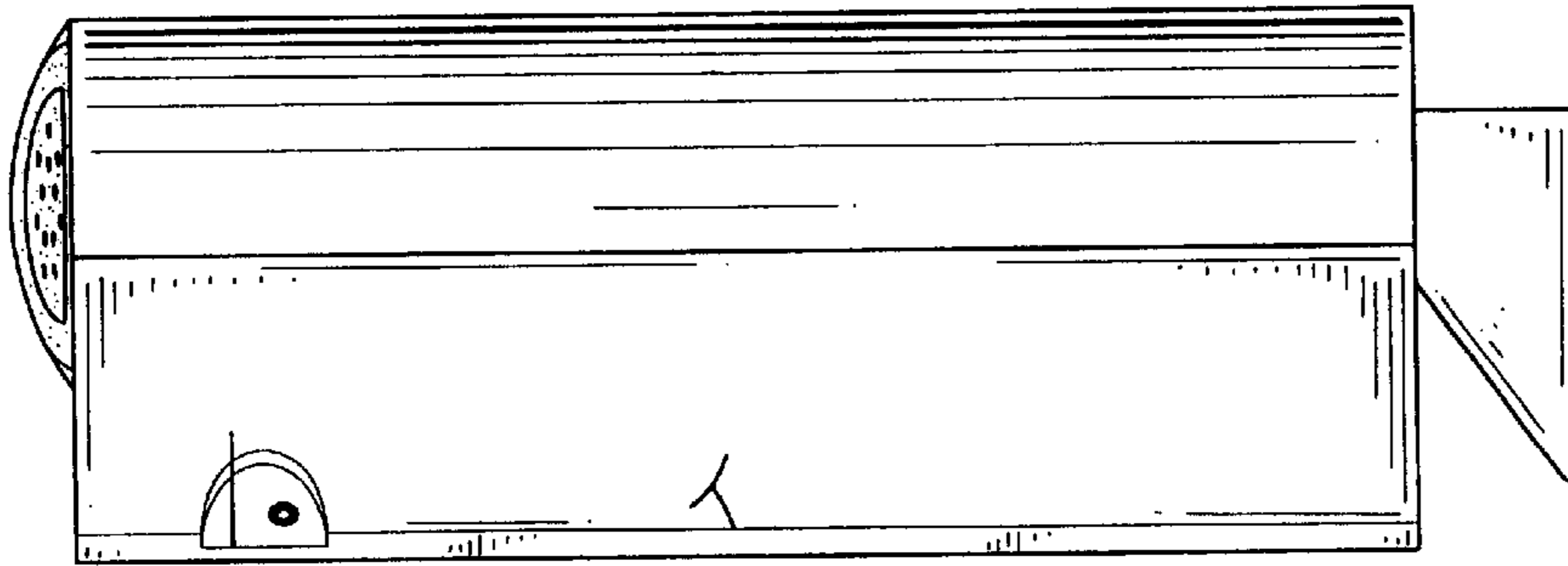

FIG.5

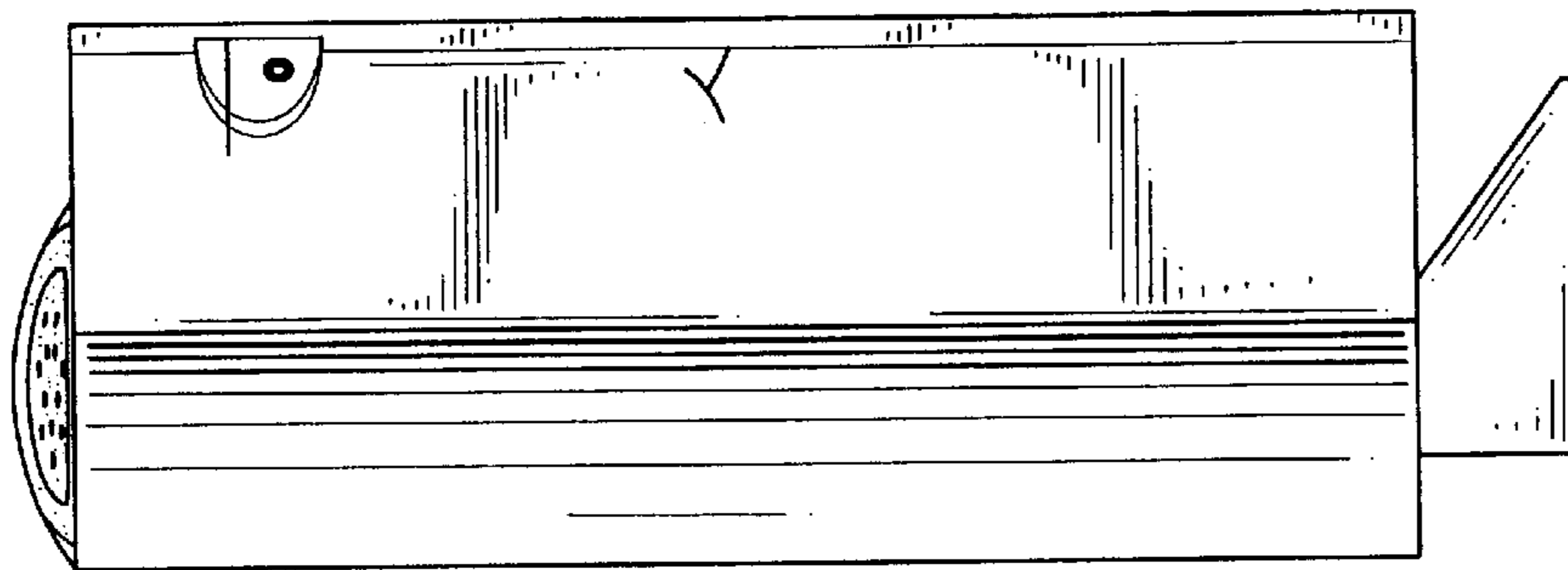

FIG.4

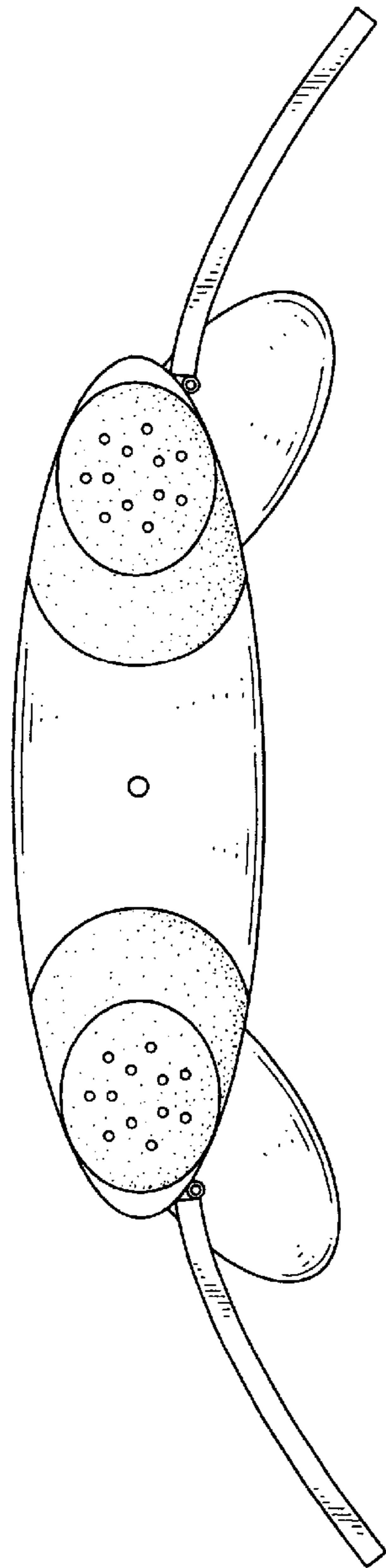

FIG. 6

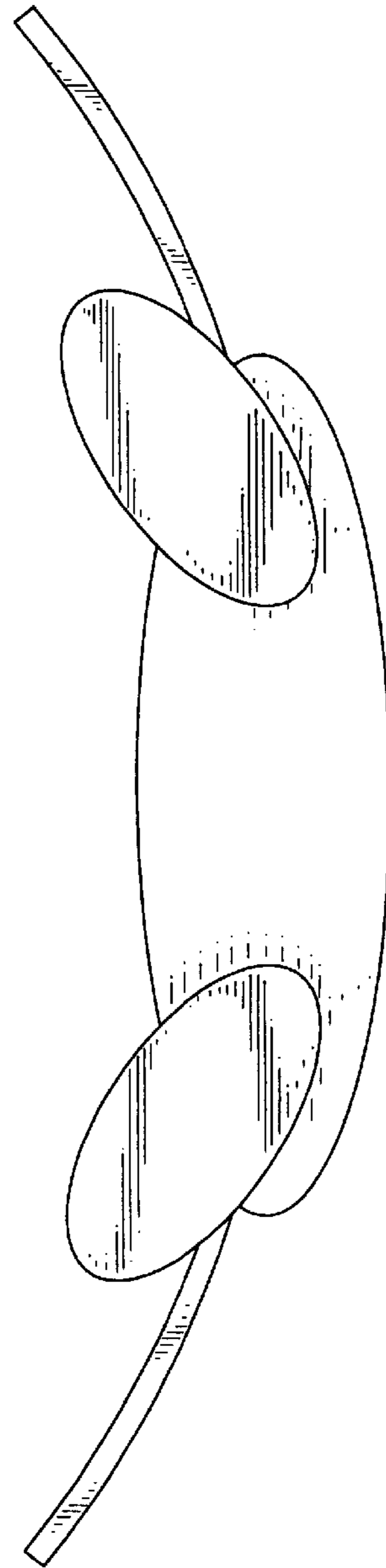

FIG. 7

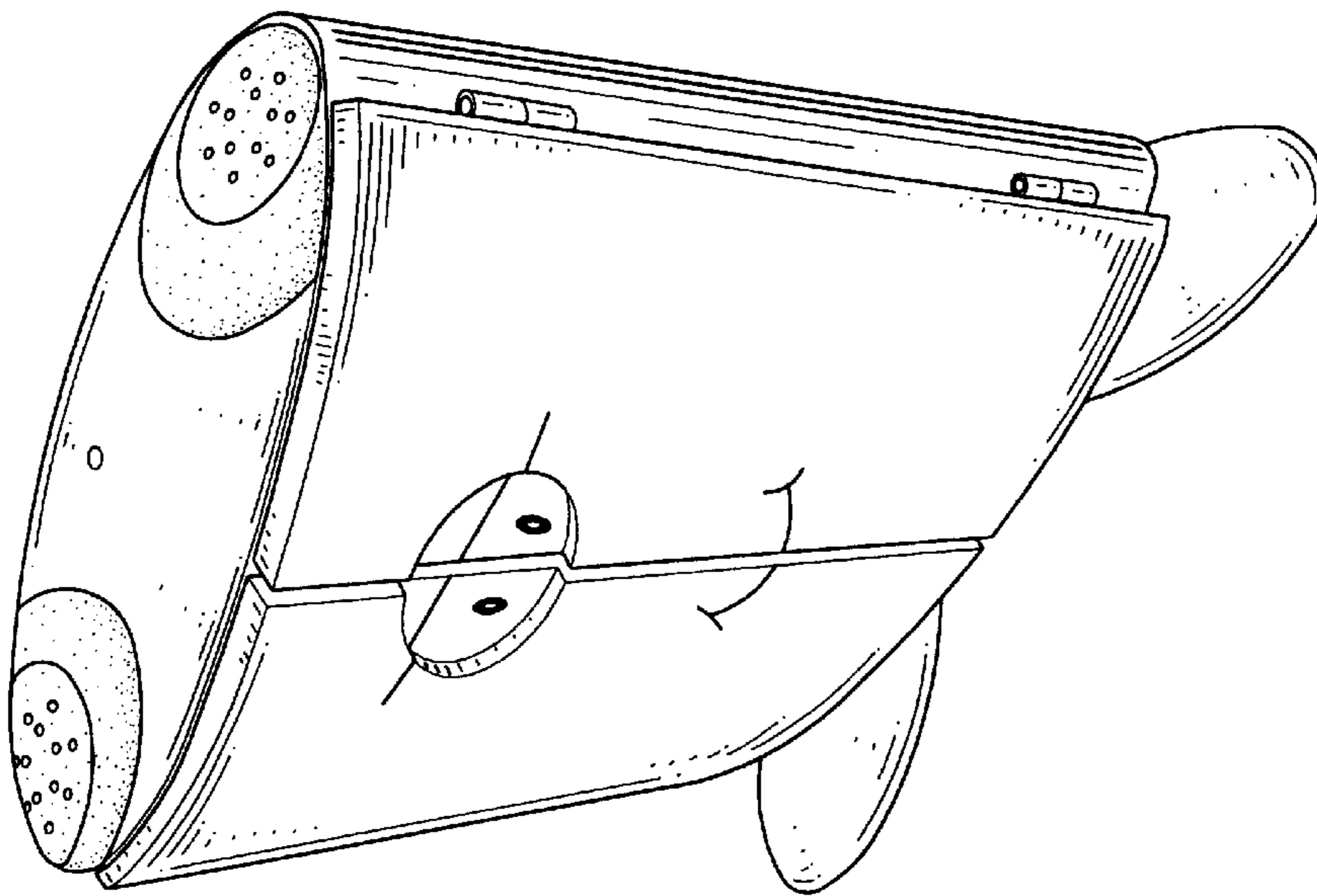

FIG.8