



US00D521415S

(12) **United States Design Patent**
Kojima et al.

(10) **Patent No.:** **US D521,415 S**
(45) **Date of Patent:** **** May 23, 2006**

(54) **MOTOR SCOOTER**

D488,102 S 4/2004 Shimokawa et al.

(75) Inventors: **Tetsuo Kojima**, Wako (JP); **Fujio Nakamura**, Wako (JP); **Kenji Tako**, Wako (JP)

FOREIGN PATENT DOCUMENTS

JP 1091302 11/2000

(73) Assignee: **Honda Motor Co., Ltd.**, Tokyo (JP)

Primary Examiner—Alan P. Douglas

Assistant Examiner—Linda Brooks

(**) Term: **14 Years**

(74) *Attorney, Agent, or Firm*—Arent Fox, PLLC

(21) Appl. No.: **29/234,715**

(57) **CLAIM**

(22) Filed: **Jul. 22, 2005**

The ornamental design for a motor scooter, as shown and described.

Related U.S. Application Data

DESCRIPTION

(63) Continuation of application No. 29/203,278, filed on Apr. 13, 2004, now abandoned.

FIG. 1 is a front view of a motor scooter showing my new design.

(30) **Foreign Application Priority Data**

Oct. 14, 2003 (JP) 2003-030233

FIG. 2 is a rear view thereof.

(51) **LOC (8) Cl.** **12-11**

(52) **U.S. Cl.** **D12/110**

(58) **Field of Classification Search** D12/110;
180/219, 220, 225, 229

FIG. 3 is a plan view thereof.

FIG. 4 is a bottom view thereof.

FIG. 5 is a right side view thereof.

FIG. 6 is a left side view thereof.

FIG. 7 is a perspective view thereof as seen from the right front side.

FIG. 8 is a perspective view thereof as seen from the right rear side.

FIG. 9 is a perspective view thereof as seen from the left front side; and,

FIG. 10 is a perspective view thereof as seen from the left rear side.

See application file for complete search history.

(56) **References Cited**

U.S. PATENT DOCUMENTS

D443,849 S 6/2001 Chen
D455,677 S 4/2002 Kokubu et al.

1 Claim, 5 Drawing Sheets

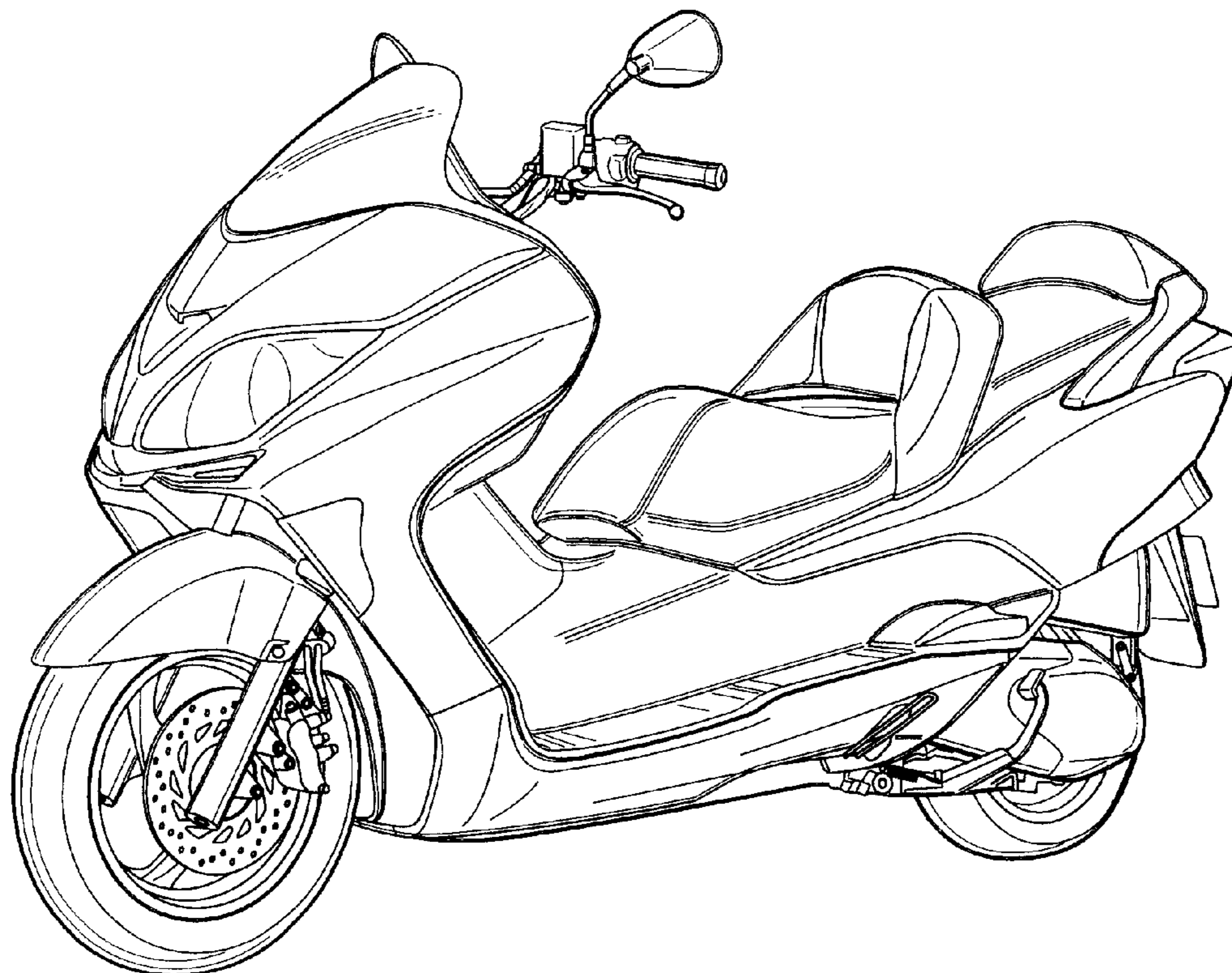

FIG.1

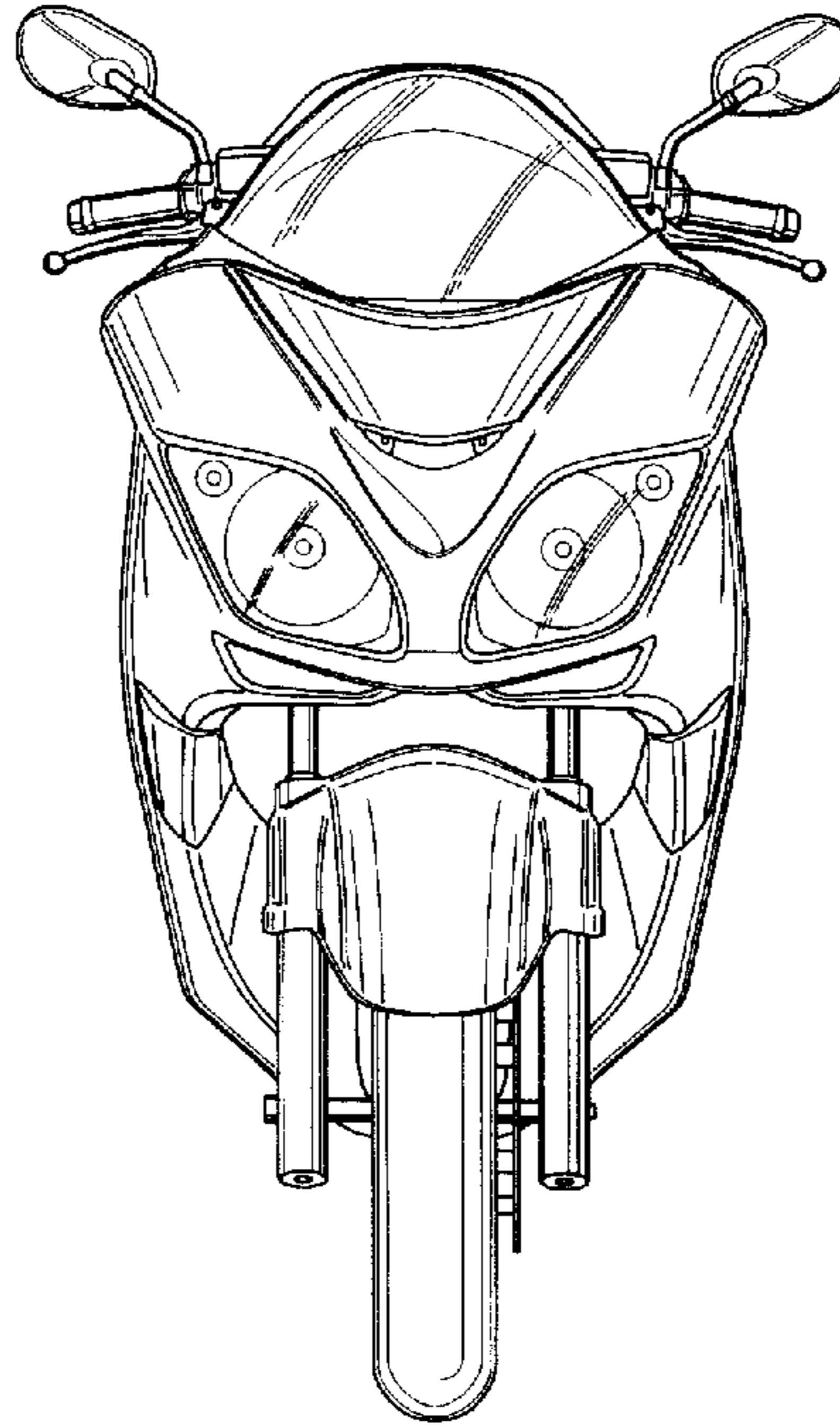

FIG.2

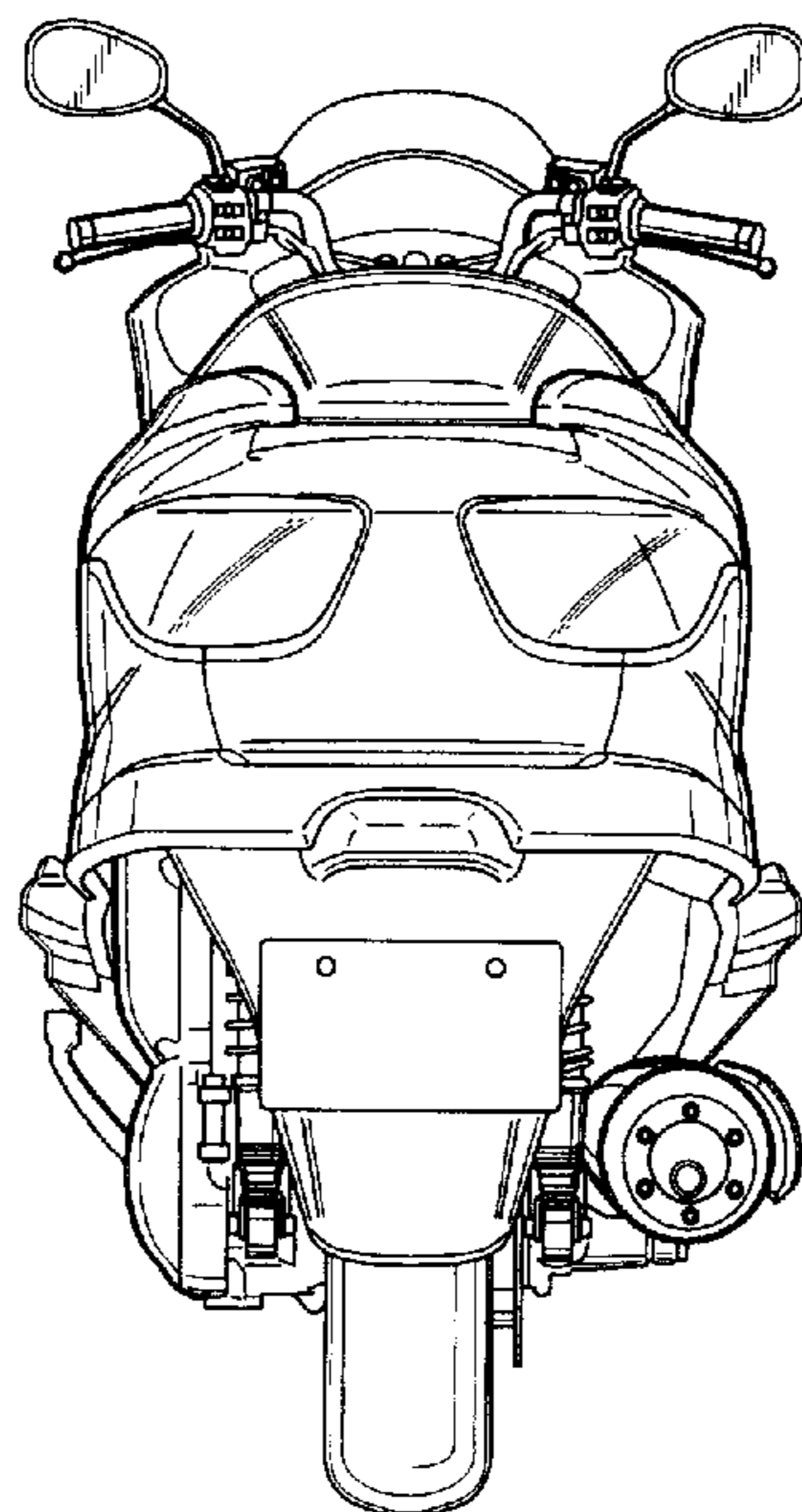

FIG.3

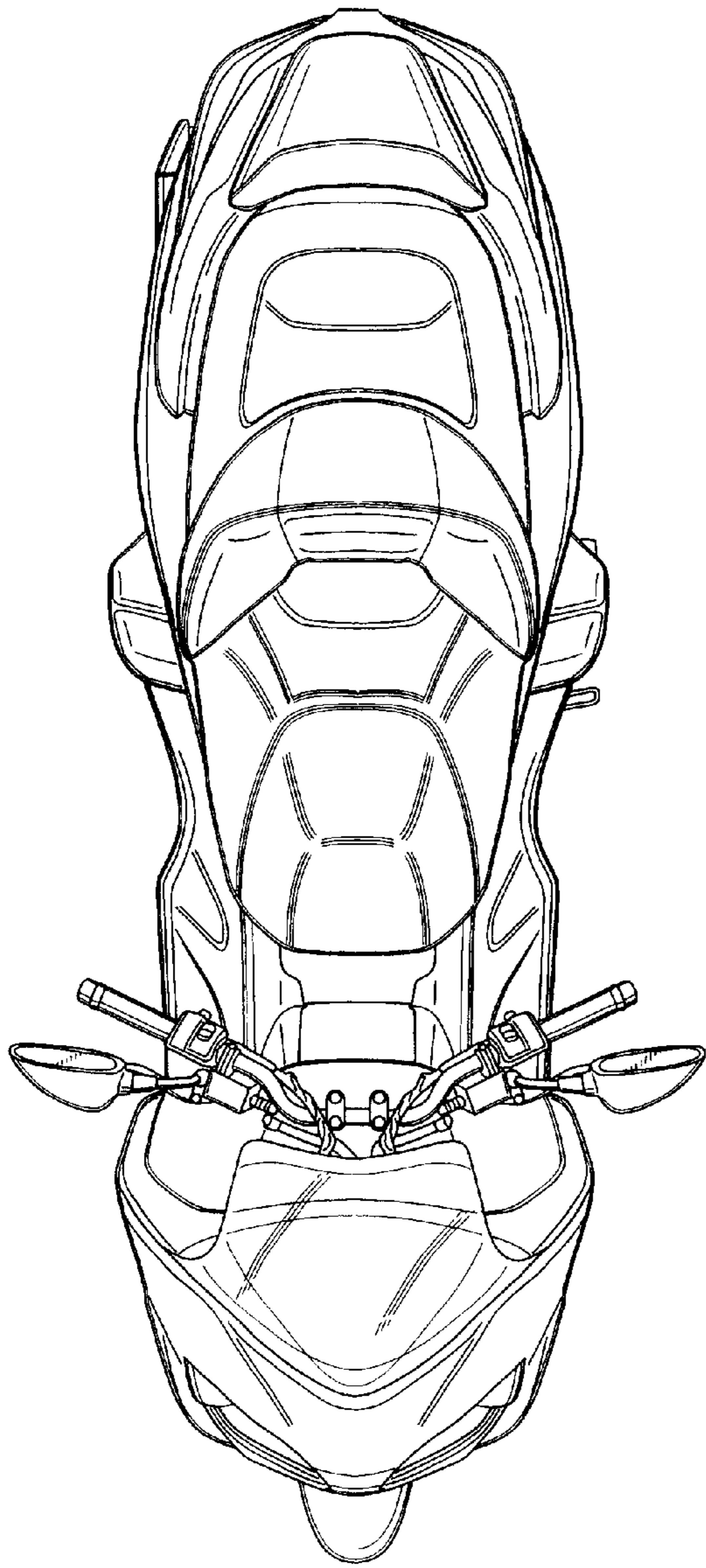

FIG.4

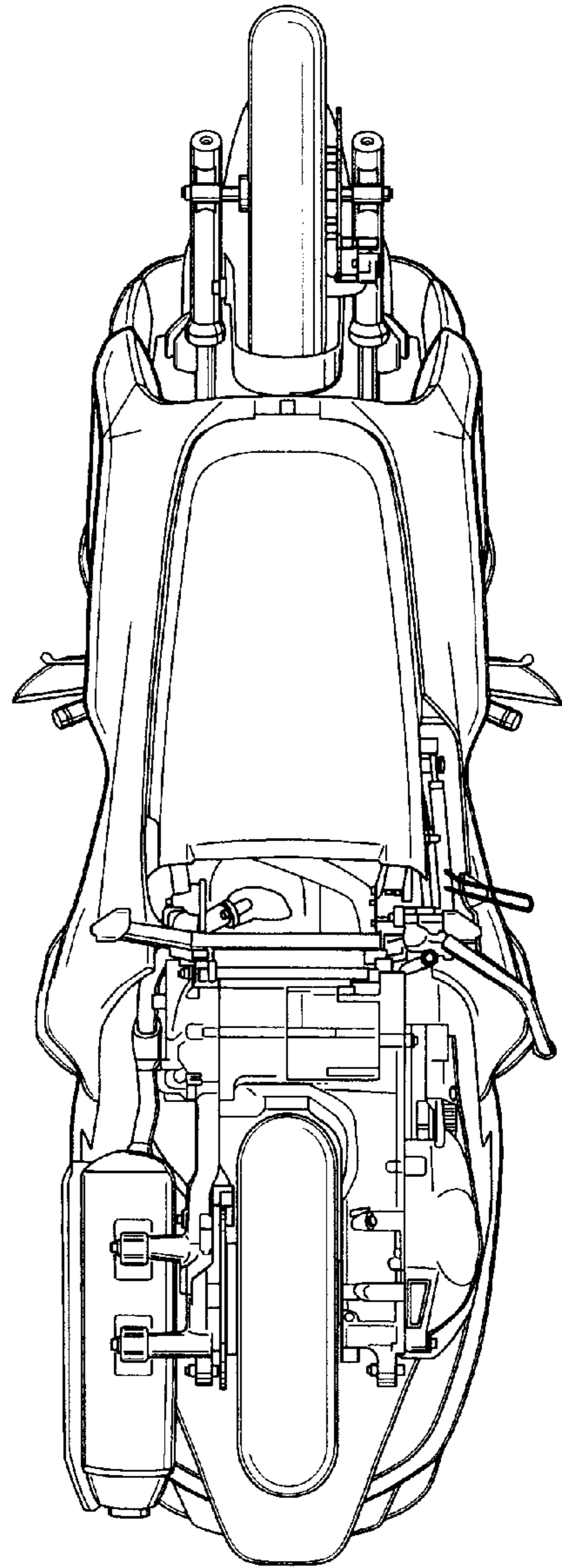

FIG.5

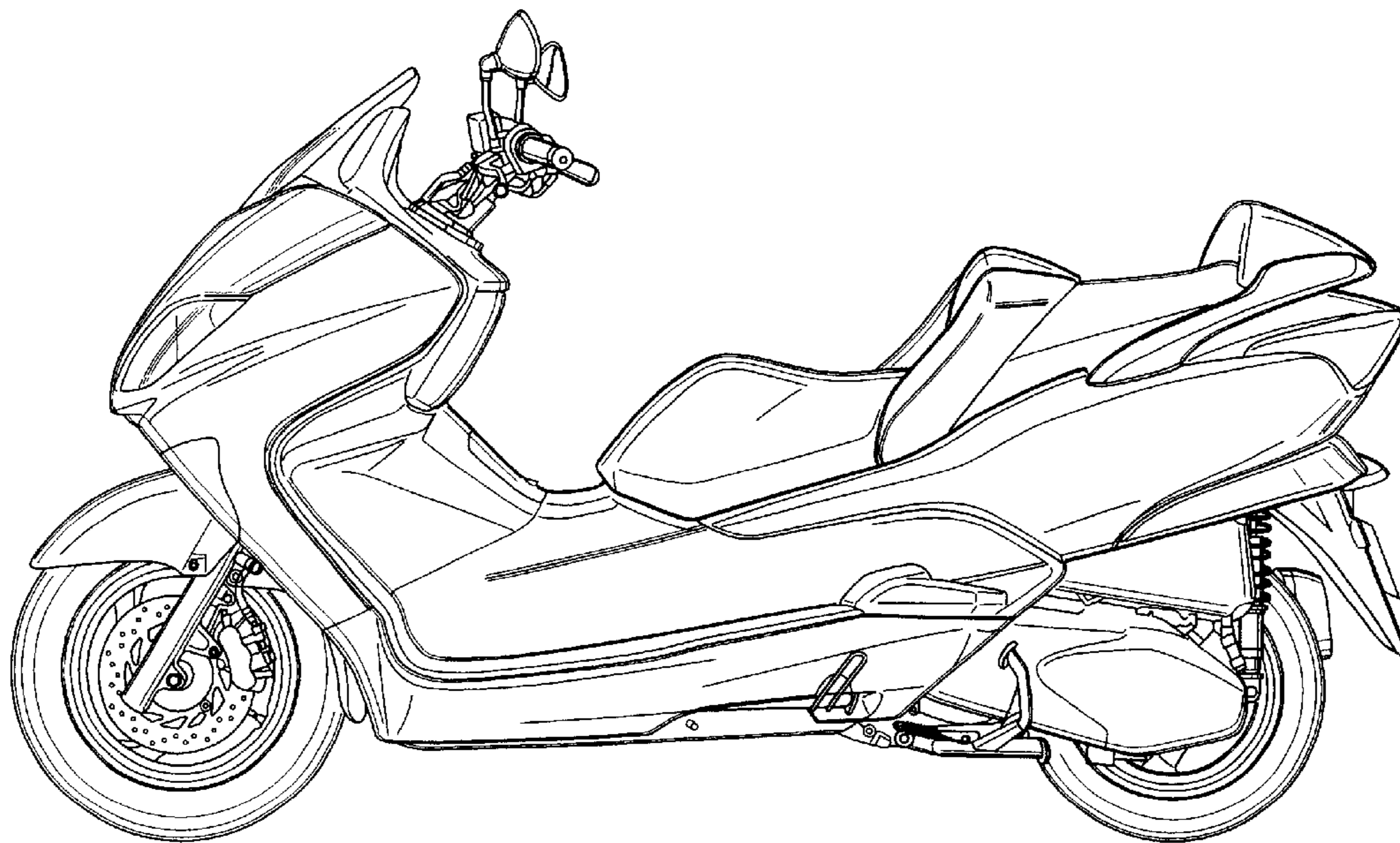

FIG.6

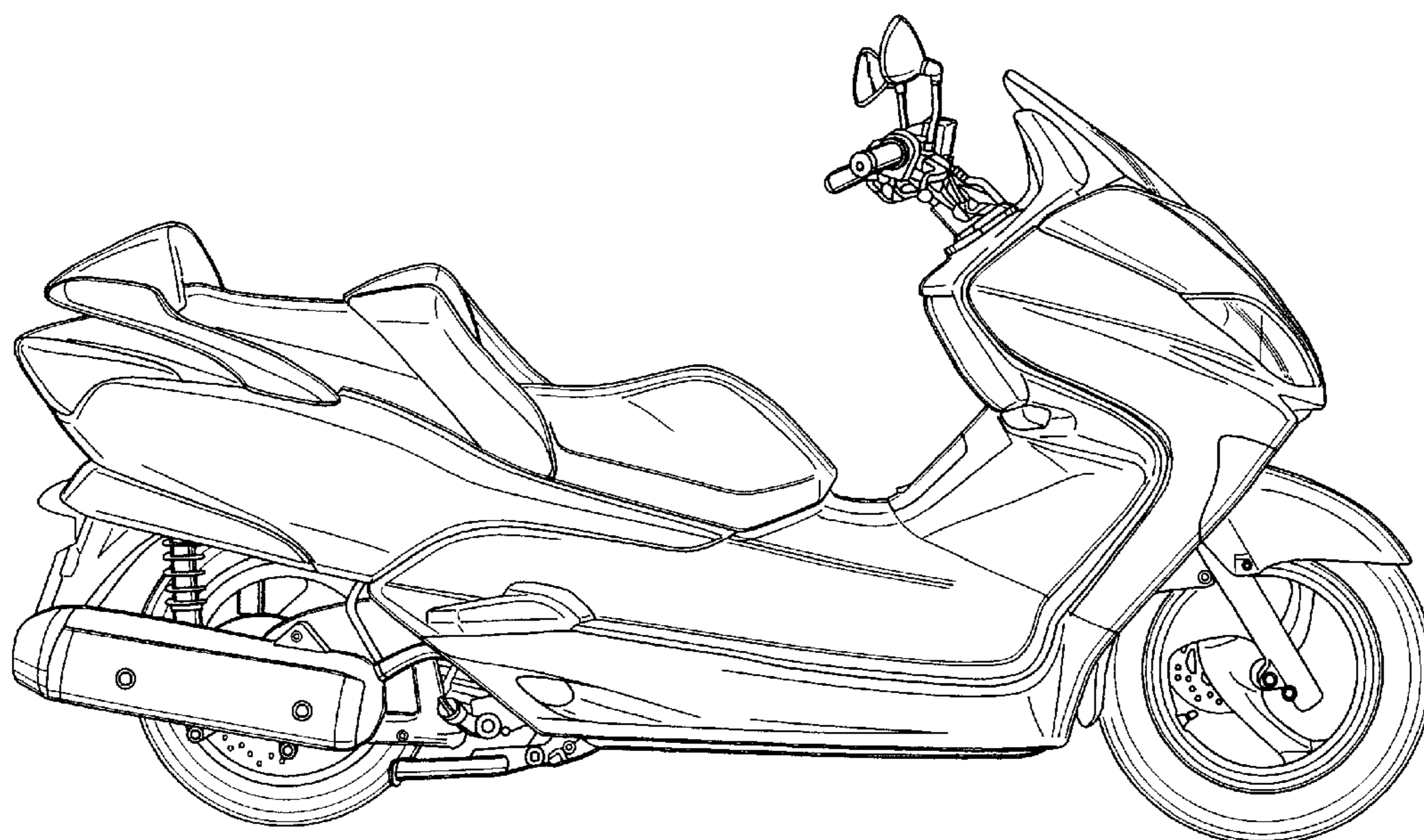

FIG.7

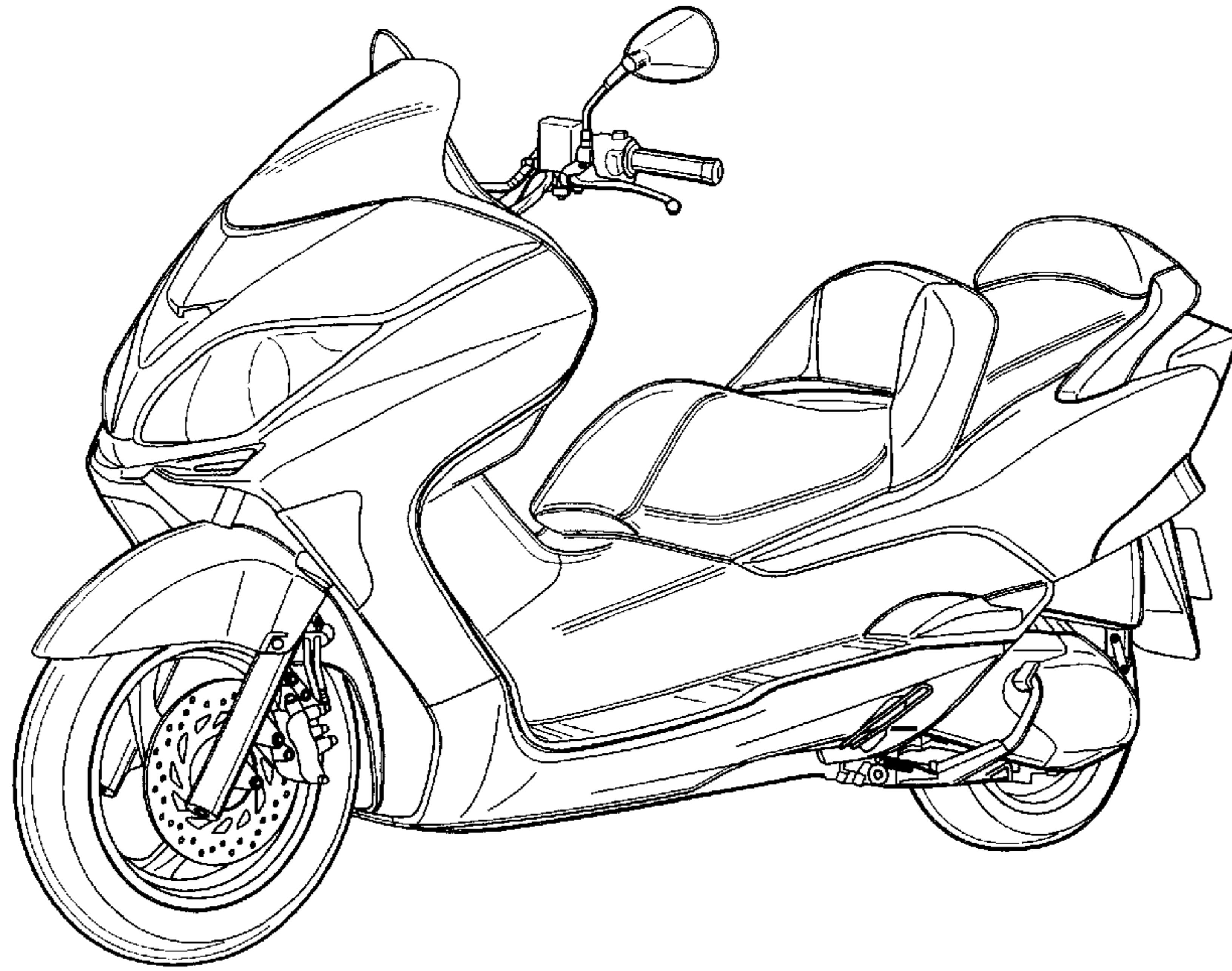

FIG.8

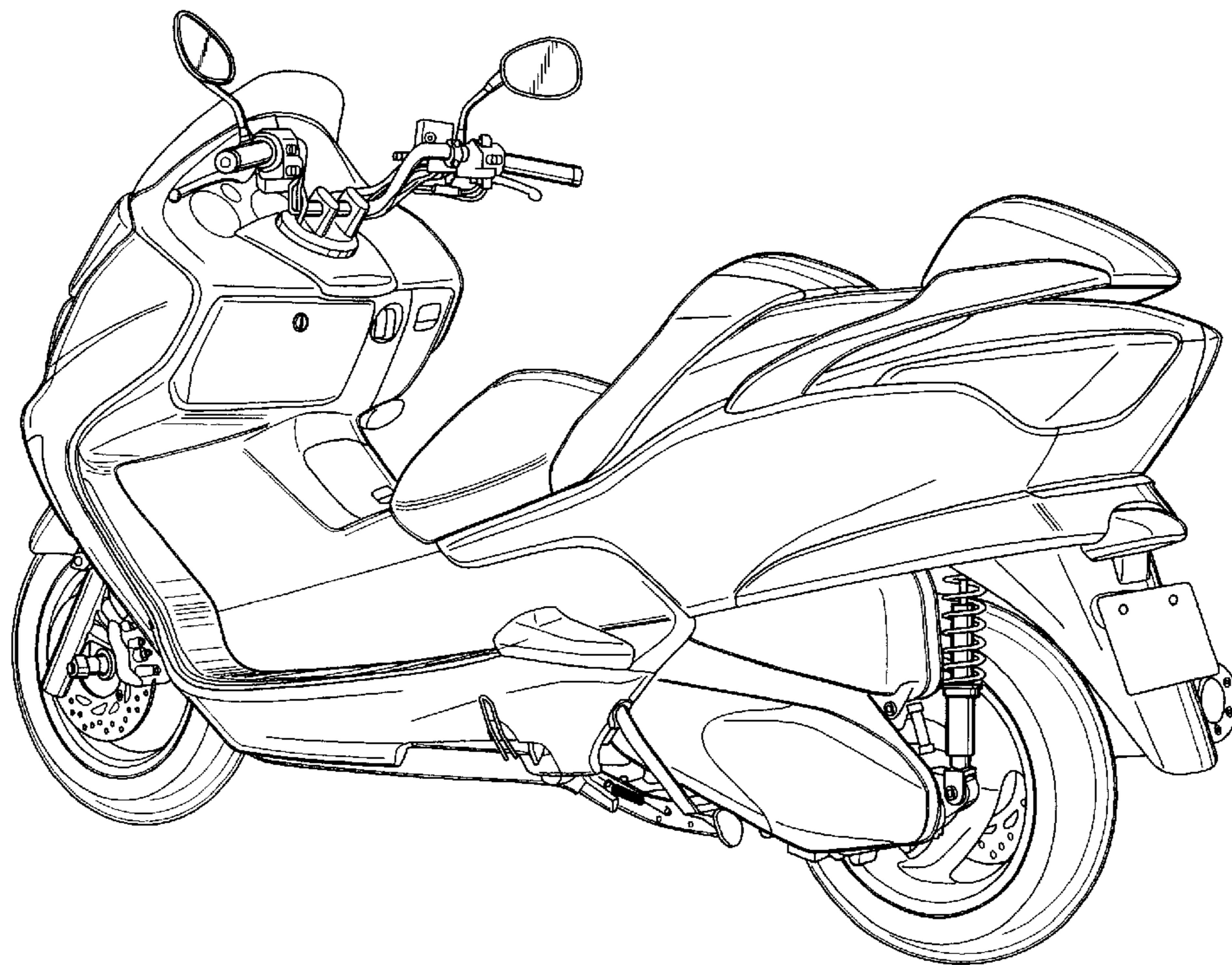

FIG.9

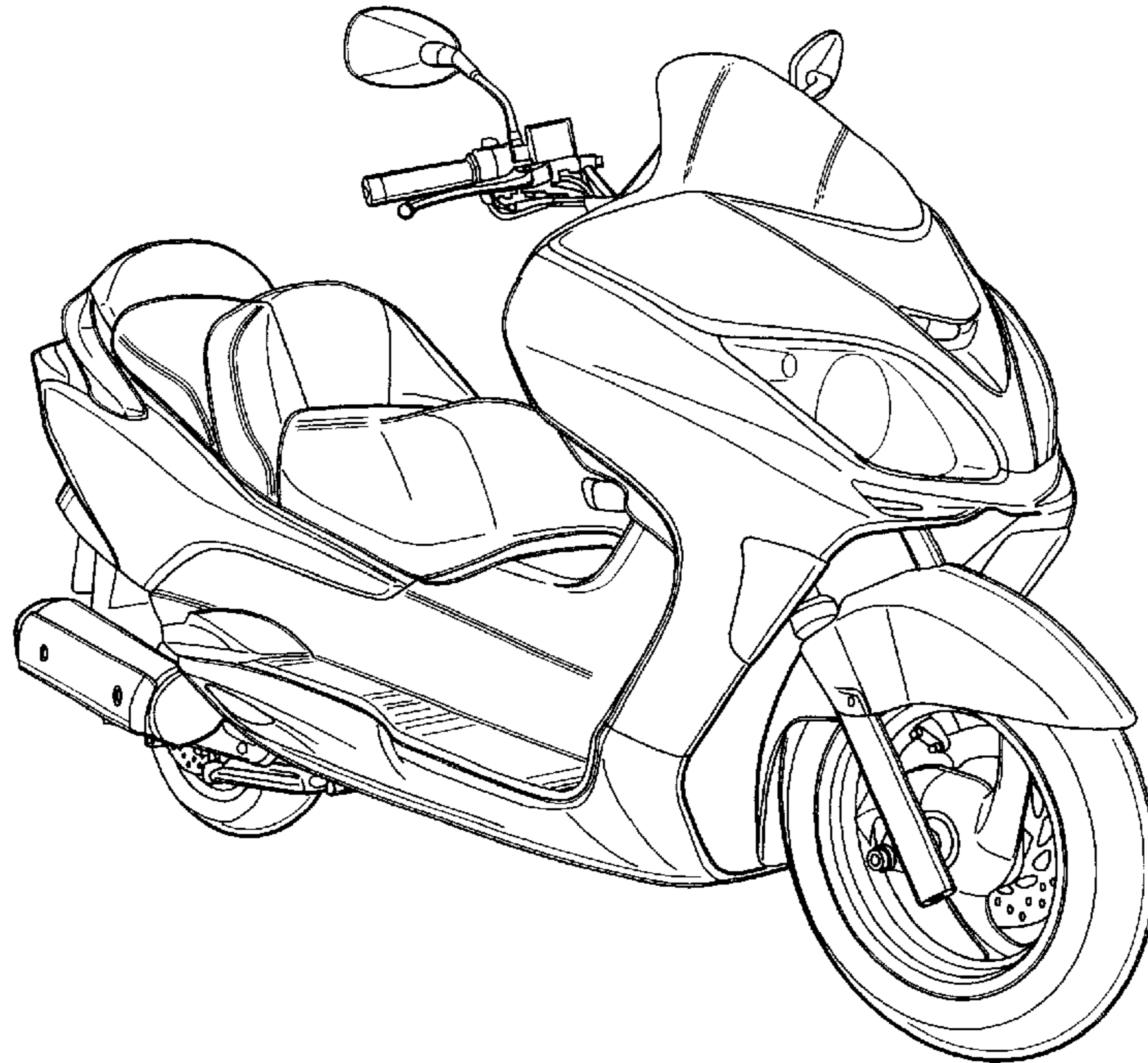

FIG.10

