



US00D521291S

(12) **United States Design Patent**  
**Ferrer Beltran**

(10) **Patent No.:** **US D521,291 S**

(45) **Date of Patent:** **\*\* May 23, 2006**

(54) **TOWEL HOLDER**

(75) Inventor: **José Maria Ferrer Beltran**, Valencia (ES)

(73) Assignee: **Sonia, S.A.**, Valencia (ES)

(\*\*) Term: **14 Years**

(21) Appl. No.: **29/230,366**

(22) Filed: **May 20, 2005**

(51) **LOC (8) Cl.** ..... **06-04**

(52) **U.S. Cl.** ..... **D6/546**

(58) **Field of Classification Search** ..... D6/546-550,  
D6/518-523; D8/300, 303, 315, 321, 349,  
D8/354, 363, 373, 380; 108/28-29; 248/175,  
248/176.1, 251, 302, 309.1; 16/110.1, 412,  
16/415; 242/570, 590, 595-598; 211/13.1,  
211/16, 60.1, 100, 86.01, 87.01, 88.01, 88.04,  
211/105.1, 105.2, 123, 182, 181.1

See application file for complete search history.

(56) **References Cited**

**U.S. PATENT DOCUMENTS**

- 2,632,605 A \* 3/1953 Lee ..... 242/597.3
- D218,331 S \* 8/1970 Ulf ..... D6/523
- 4,836,462 A \* 6/1989 Bruss ..... 242/598.2
- D424,353 S \* 5/2000 Duggan ..... D6/550
- D450,503 S \* 11/2001 Gottwald ..... D6/523
- D455,587 S \* 4/2002 Ou-Young ..... D6/523

- D465,365 S \* 11/2002 Moore ..... D6/523
- 6,554,222 B1 \* 4/2003 Lindow, Sr. .... 242/598.5
- D477,167 S \* 7/2003 Hoernig ..... D6/523
- D477,481 S \* 7/2003 Ouano ..... D6/523
- D477,731 S \* 7/2003 Hoernig ..... D6/523

\* cited by examiner

*Primary Examiner*—Brian N Vinson

(74) *Attorney, Agent, or Firm*—Jacobson Holman PLLC

(57) **CLAIM**

I claim the ornamental design for the towel holder, as shown and described.

**DESCRIPTION**

FIG. 1 is a front perspective view of the towel holder embodying my design;  
 FIG. 2 is the top plan view of the towel holder as shown in FIG. 1;  
 FIG. 3 is the bottom view of the towel holder as shown in FIG. 1;  
 FIG. 4 is the right end elevational view of the towel holder as shown in FIG. 1;  
 FIG. 5 is the left end elevational view of the towel holder as shown in FIG. 1;  
 FIG. 6 is the left side elevational view of the towel holder as shown in FIG. 1; and,  
 FIG. 7 is the right side elevational view of the towel holder as shown in FIG. 1.

**1 Claim, 4 Drawing Sheets**

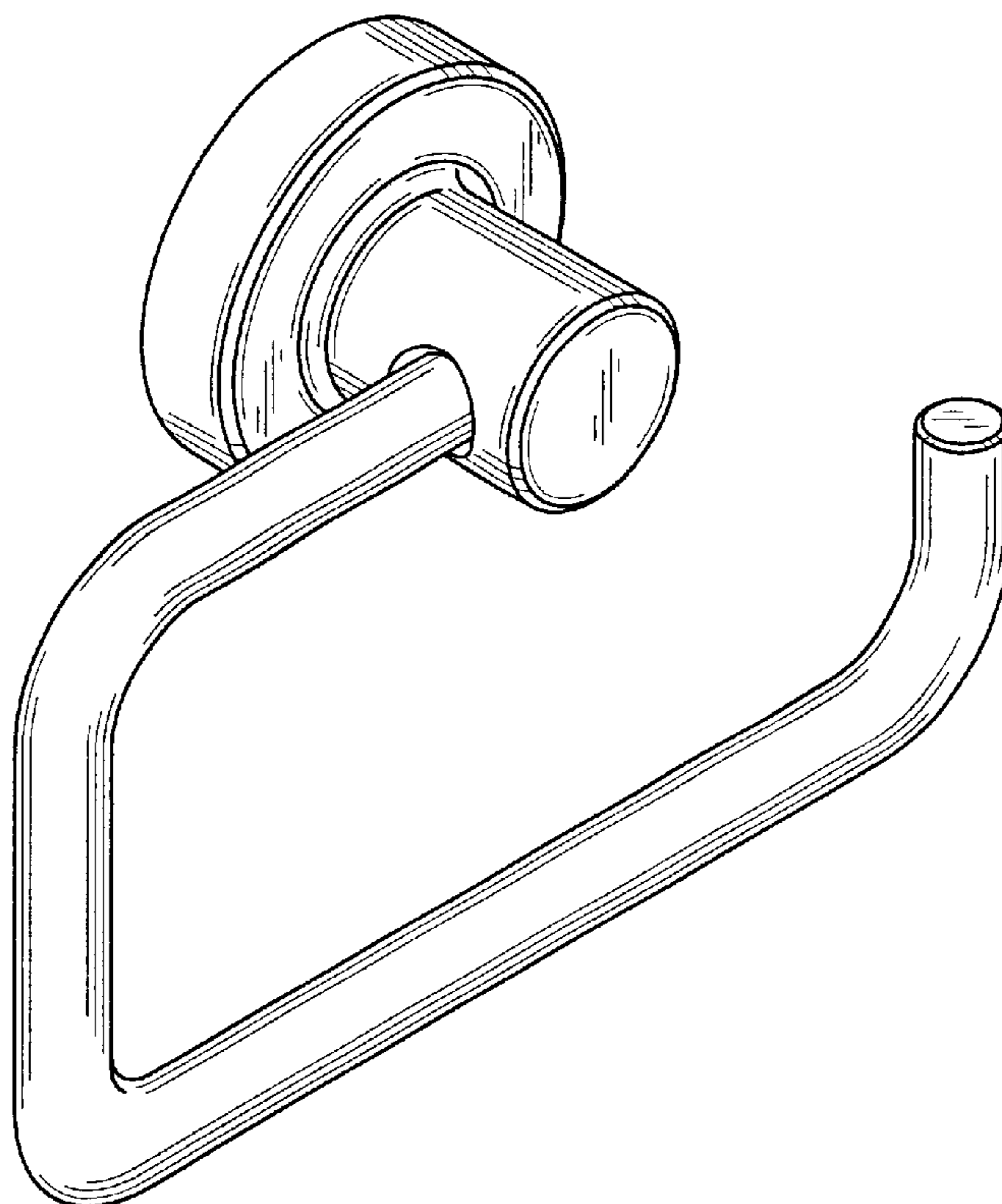

FIG. 1

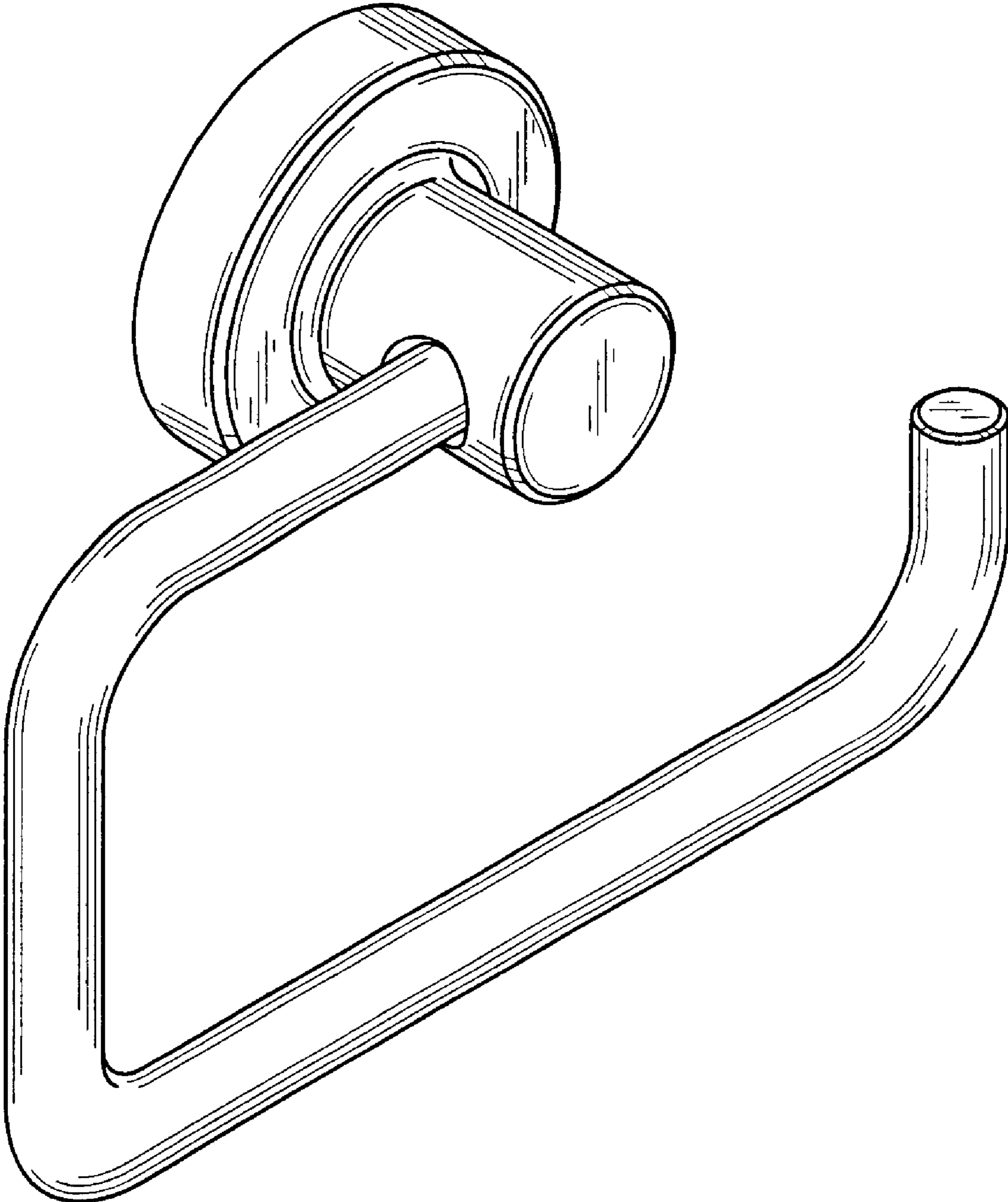

FIG. 2

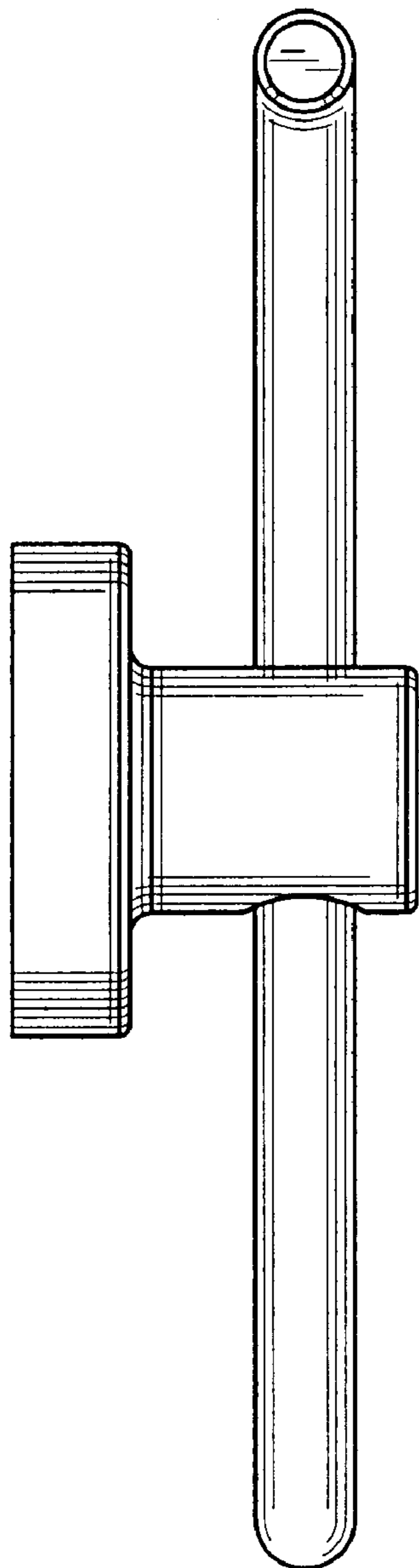

FIG. 3

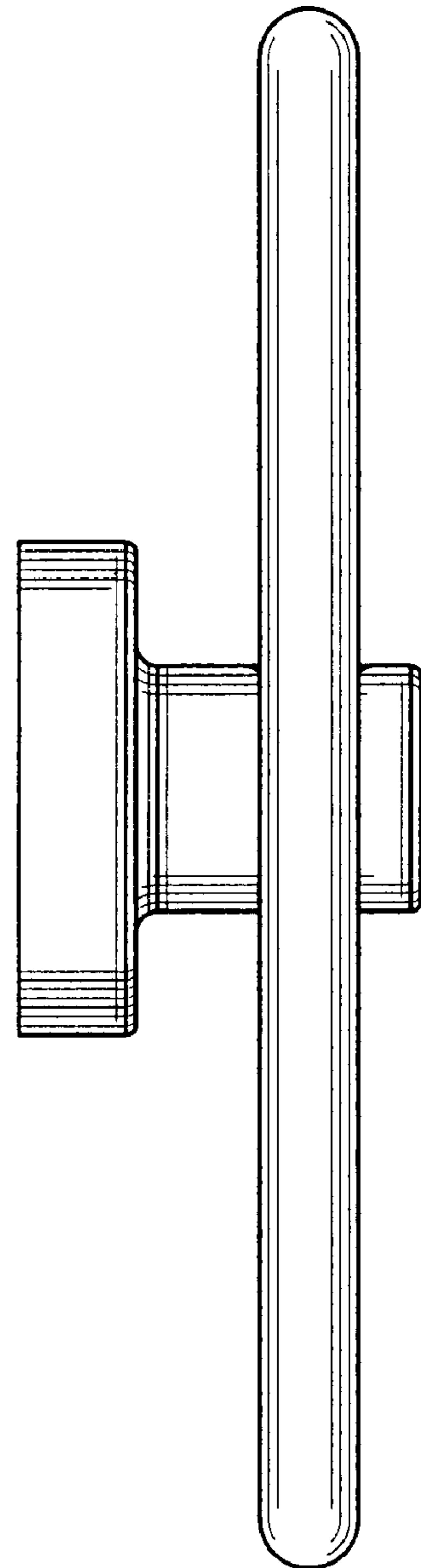

FIG. 4

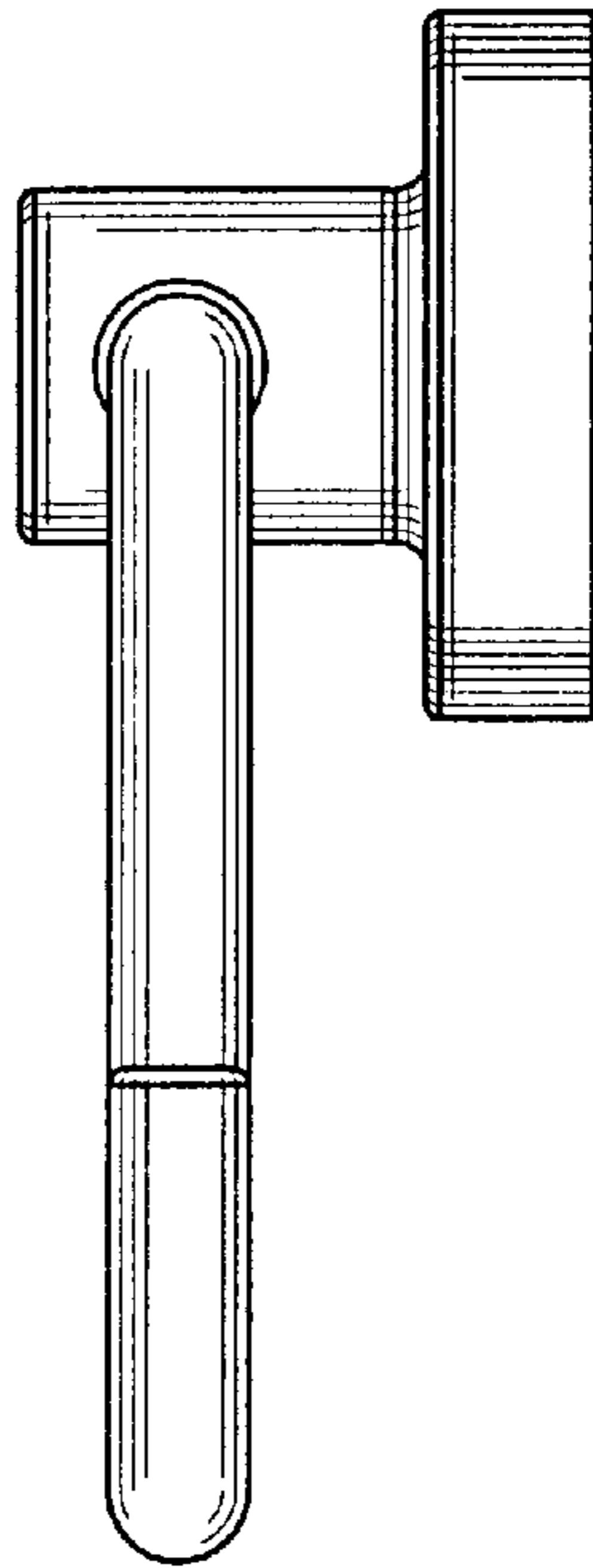

FIG. 5

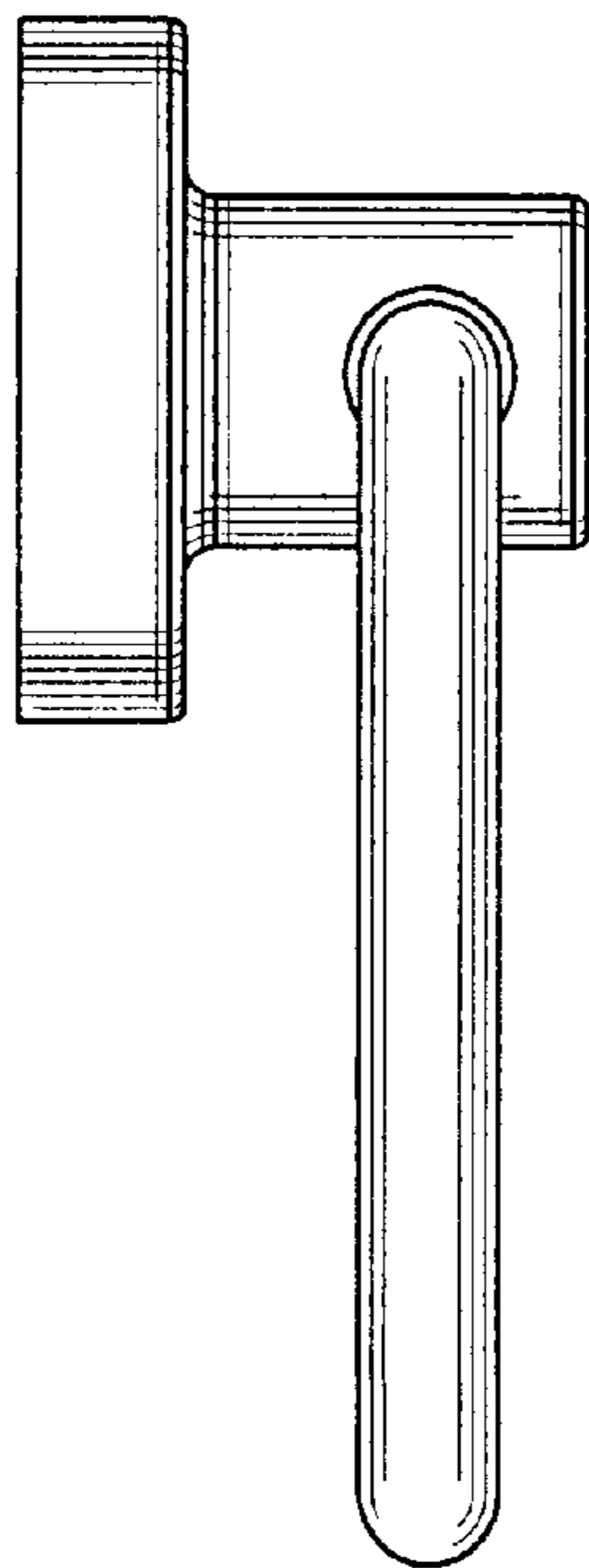

FIG. 6

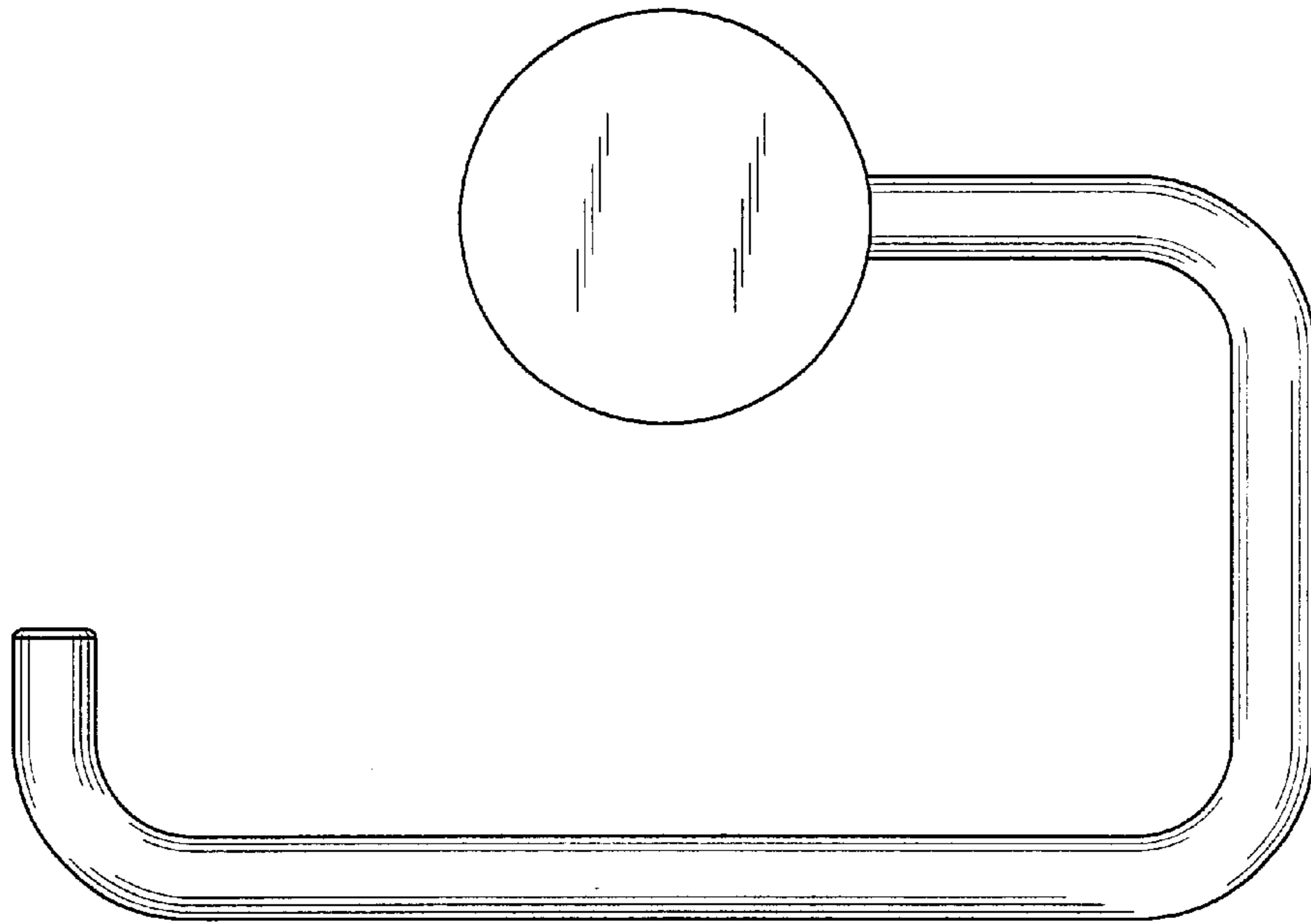

FIG. 7

