



US00D521185S

(12) **United States Design Patent**
Lin

(10) **Patent No.:** **US D521,185 S**

(45) **Date of Patent:** **** May 16, 2006**

(54) **LIGHTHOUSE LIGHTER**

D78,877 S * 7/1929 Cromwell D27/150
D81,806 S * 8/1930 Oneil D27/148

(76) Inventor: **Rong Lin**, 109 Kings Mountain Dr.,
Greer, SC (US) 29650

* cited by examiner

(**) Term: **14 Years**

Primary Examiner—Jennifer Rivard

(21) Appl. No.: **29/230,944**

(57) **CLAIM**

(22) Filed: **May 31, 2005**

The ornamental design for a lighthouse lighter, as shown.

(51) **LOC (8) Cl.** **27-05**

(52) **U.S. Cl.** **D27/150**

(58) **Field of Classification Search** D27/141,
D27/142, 148–151, 154–160; 431/125, 253
See application file for complete search history.

DESCRIPTION

FIG. 1 is a front elevational view thereof;
FIG. 2 is a left side elevational view thereof;
FIG. 3 is a right side elevational view thereof;
FIG. 4 is a top plan view thereof;
FIG. 5 is a bottom plan view thereof;
FIG. 6 is a front elevational view of open position thereof;
and,
FIG. 7 is a bottom plan view of open position thereof.

(56) **References Cited**

U.S. PATENT DOCUMENTS

D22,679 S * 8/1893 Negbaur D27/150
D75,188 S * 5/1928 Rice D27/150
D76,674 S * 10/1928 Florman D27/150

1 Claim, 7 Drawing Sheets

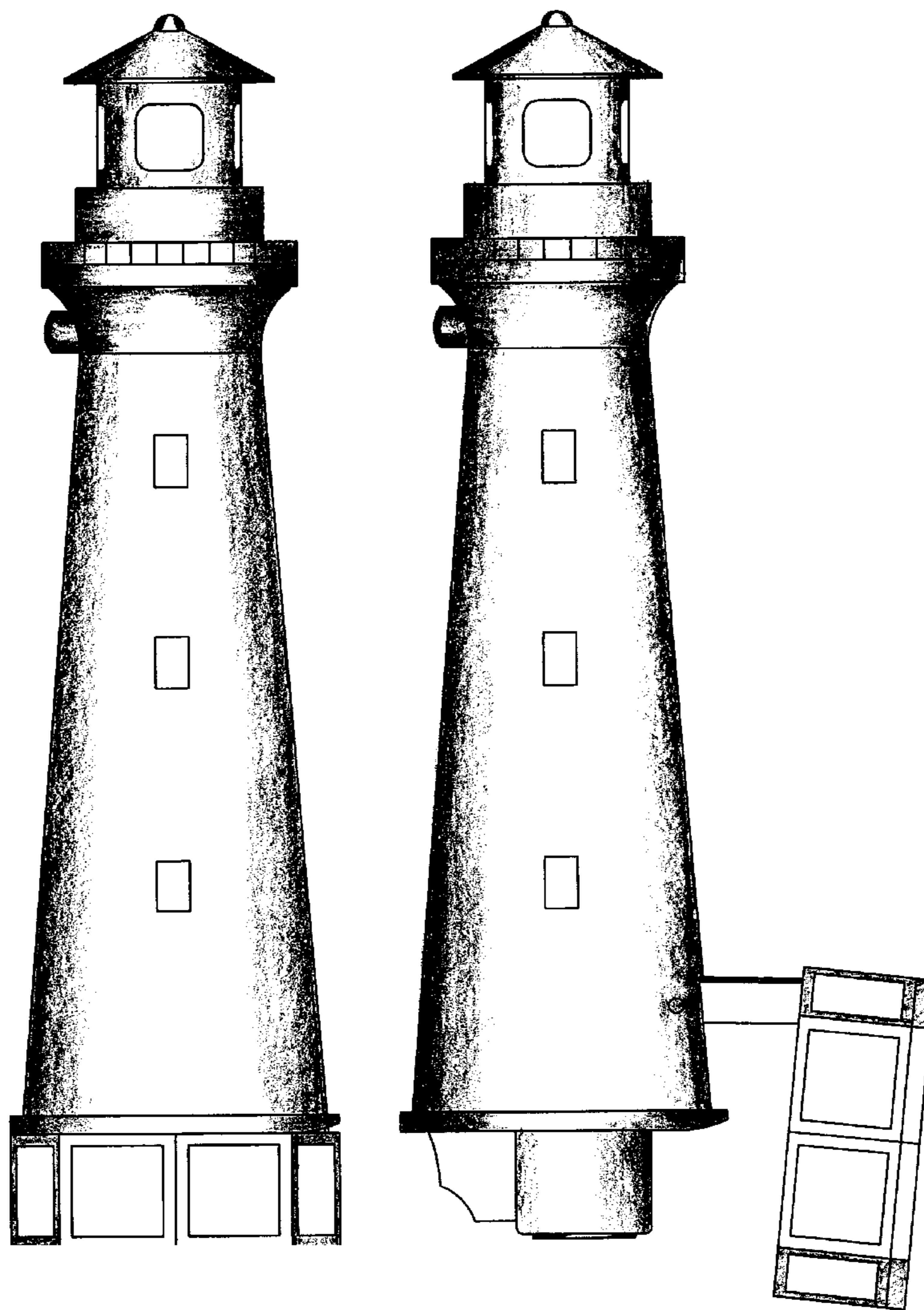

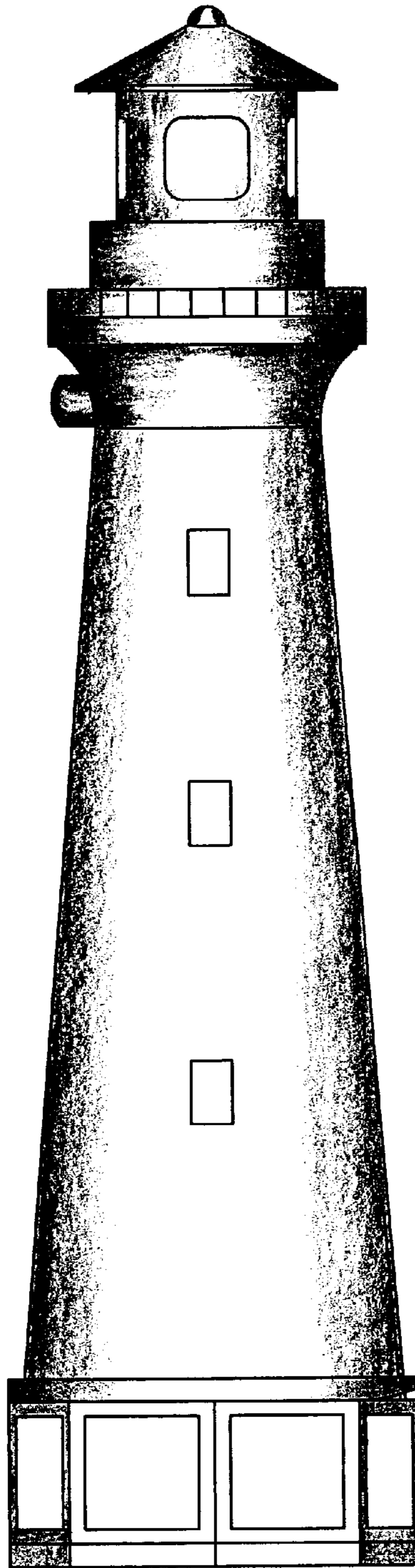

FIG. 1

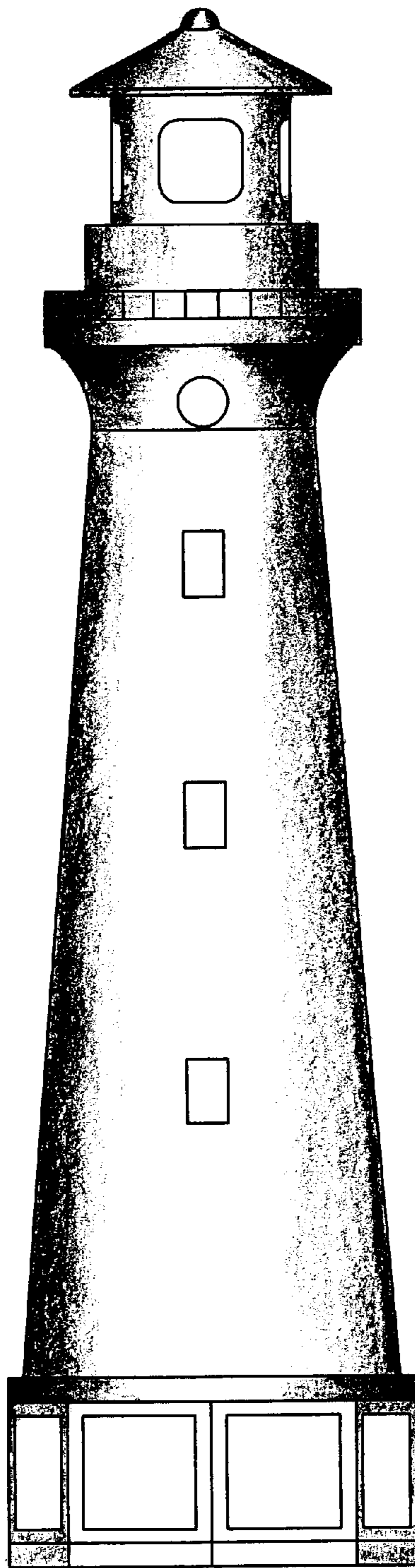

FIG. 2

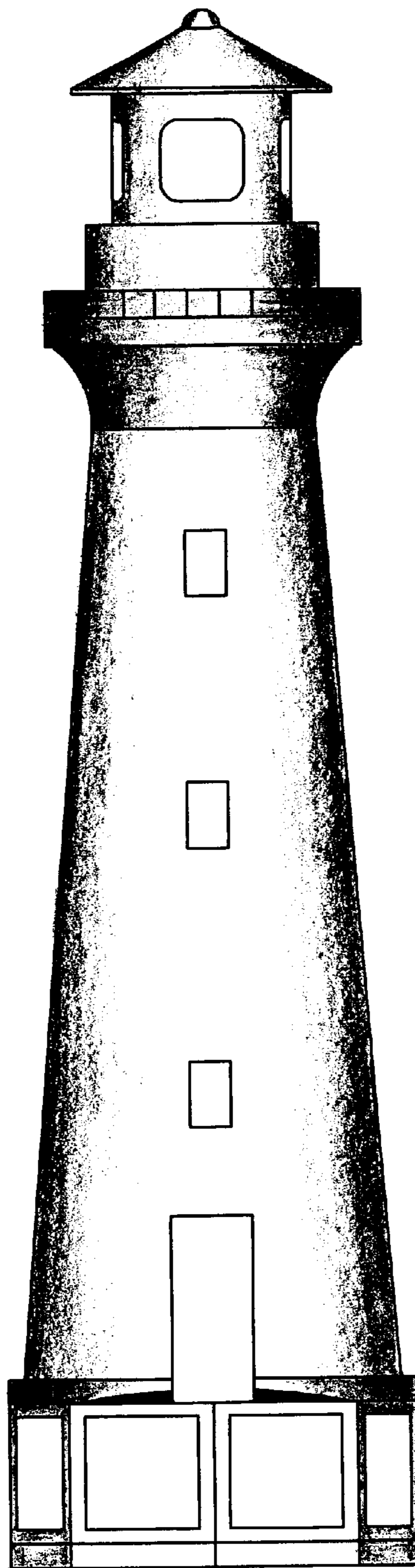

FIG. 3

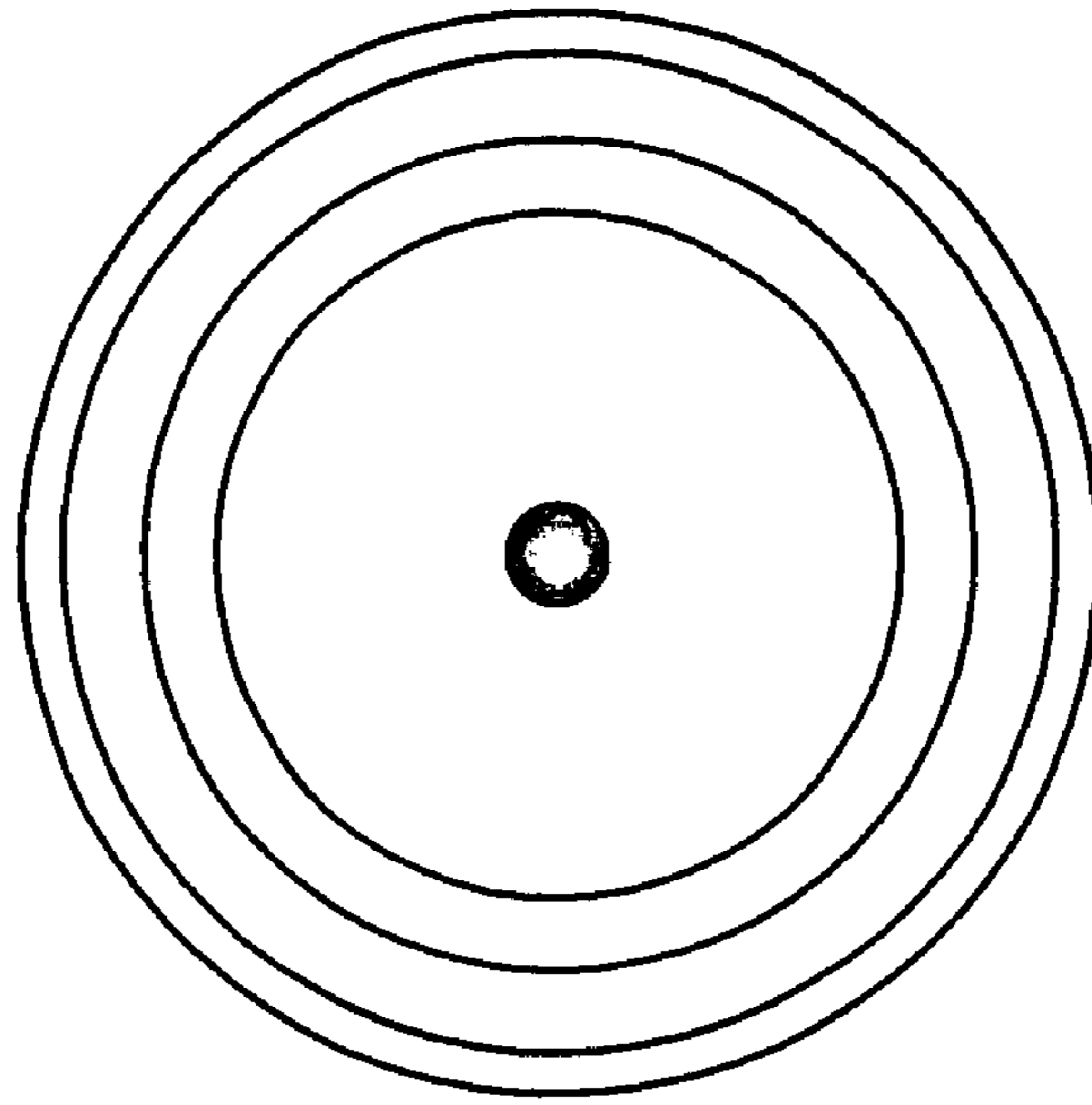

FIG. 4

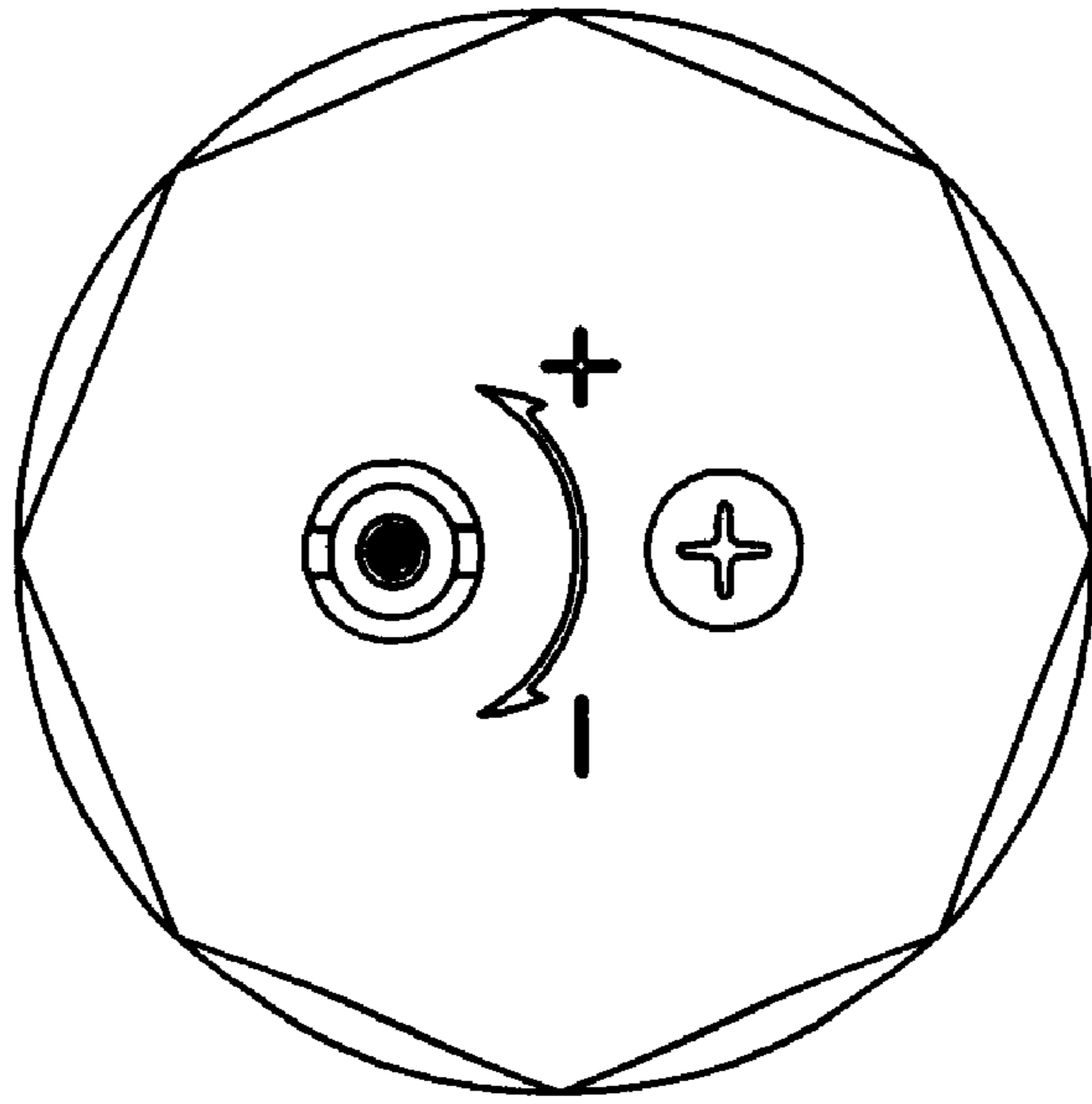

FIG. 5

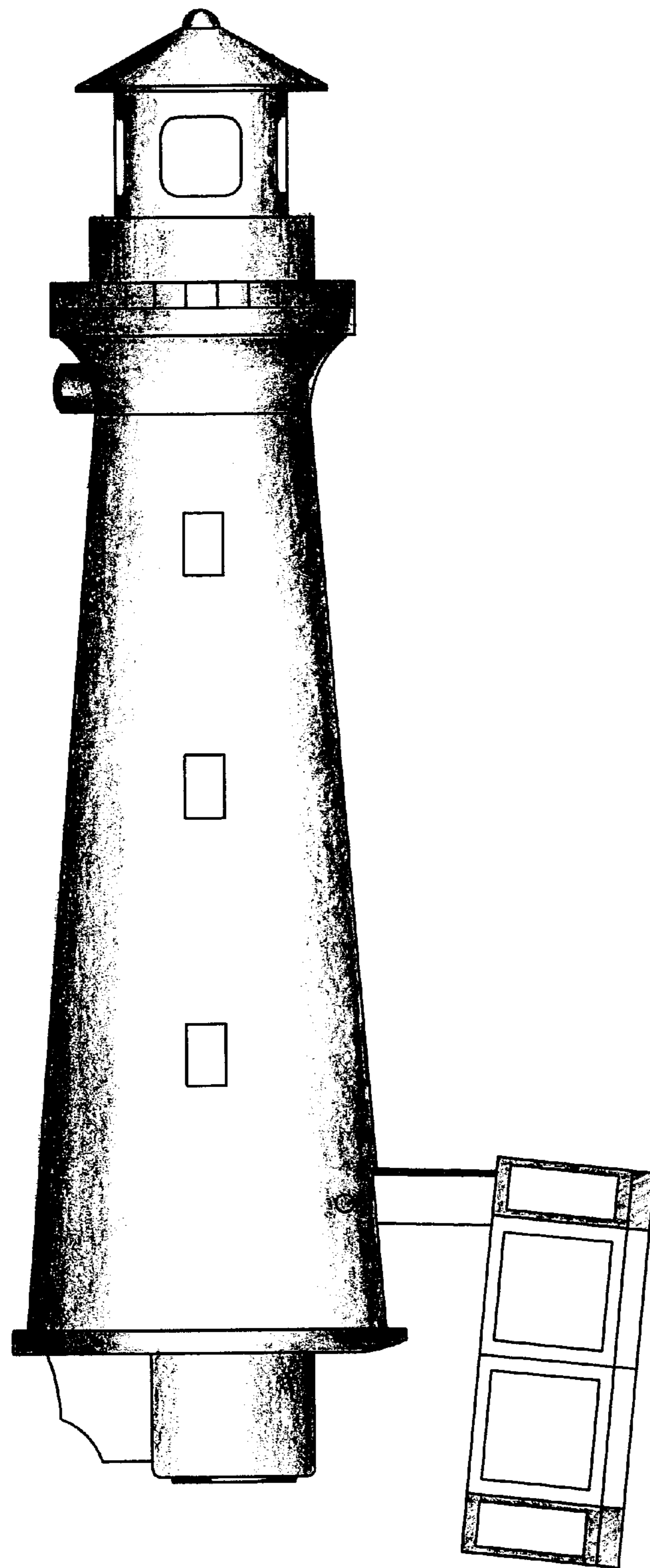

FIG. 6

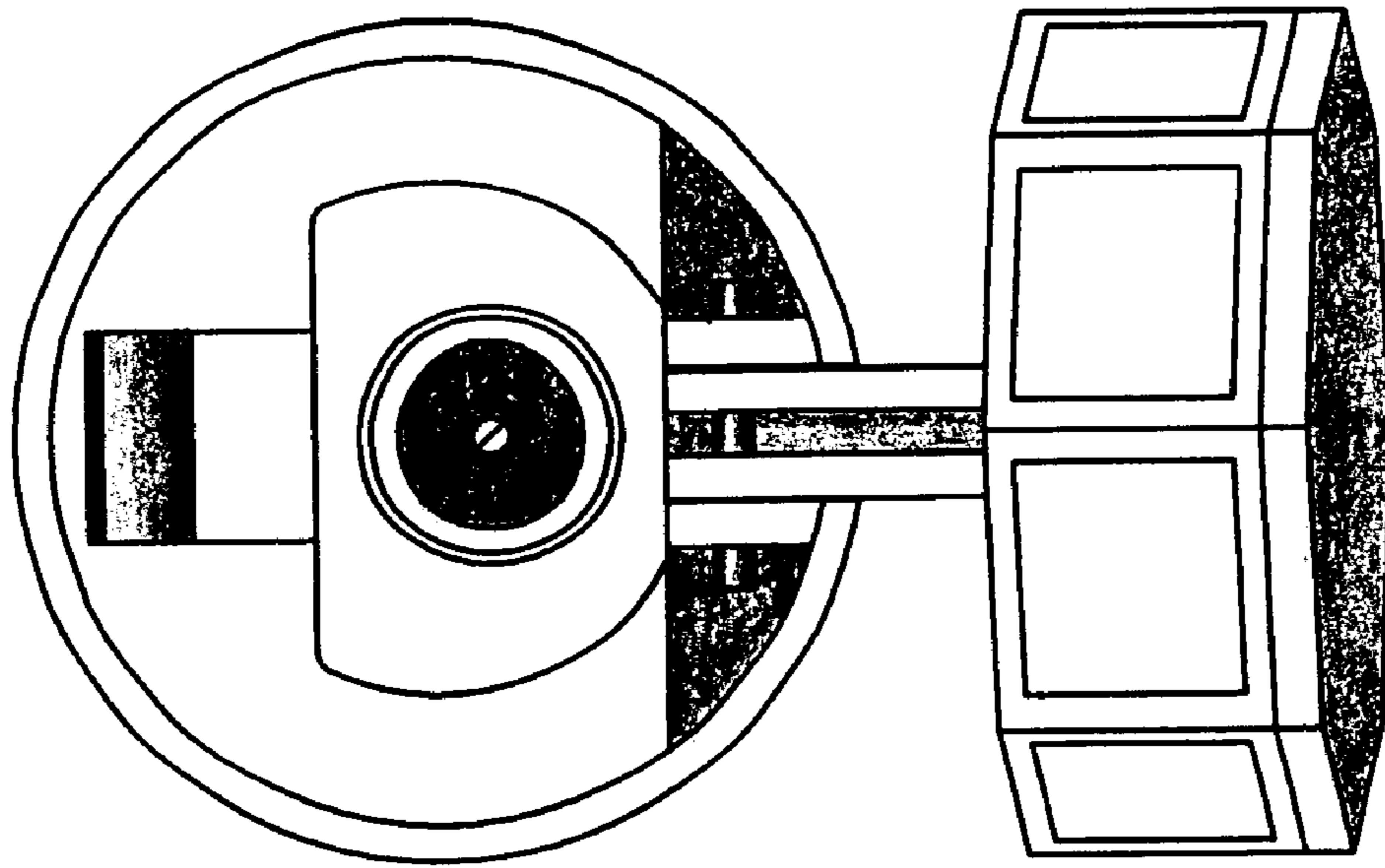

FIG. 7