

US00D521168S

(12) **United States Design Patent**
Waters

(10) **Patent No.:** **US D521,168 S**

(45) **Date of Patent:** **** May 16, 2006**

(54) **WORK LIGHT**

DESCRIPTION

(76) Inventor: **Michael Waters**, 372 Bateman Cir.
North, Barrington Hills, IL (US) 60010

(**) Term: **14 Years**

(21) Appl. No.: **29/225,215**

(22) Filed: **Mar. 11, 2005**

(51) **LOC (8) Cl.** **26-02**

(52) **U.S. Cl.** **D26/42; D10/114**

(58) **Field of Classification Search** **D26/37-50;**
D10/114; 362/157, 158, 171-174, 183-208
See application file for complete search history.

(56) **References Cited**

U.S. PATENT DOCUMENTS

D409,776 S	*	5/1999	Ghode et al.	D26/42
D436,199 S	*	1/2001	Lam	D26/42
D441,888 S	*	5/2001	Haneda et al.	D26/42
D473,332 S	*	4/2003	Lam	D26/49
D505,217 S	*	5/2005	Bayat et al.	D26/42

* cited by examiner

Primary Examiner—Marcus A. Jackson

(74) *Attorney, Agent, or Firm*—Fitch, Even, Tabin &
Flannery

(57) **CLAIM**

I claim the ornamental design for a work light, as shown and described.

FIG. 1 is a perspective view of the work light according to my new design;

FIG. 2 is a top plan view of the work light of FIG. 1;

FIG. 3 is a left side elevational view of the work light of FIG. 1;

FIG. 4 is a bottom plan view of the work light of FIG. 1;

FIG. 5 is a right side elevational view of the work light of FIG. 1;

FIG. 6 is a rear elevational view of the work light of FIG. 1;

FIG. 7 is a front elevational view of the work light of FIG. 1;

FIG. 8 is a perspective view of another work light according to my new design;

FIG. 9 is a top plan view of the work light of FIG. 8;

FIG. 10 is a left side elevational view of the work light of FIG. 8;

FIG. 11 is a bottom plan view of the work light of FIG. 8;

FIG. 12 is a right side elevational view of the work light of FIG. 8;

FIG. 13 is a rear elevational view of the work light of FIG. 8; and,

FIG. 14 is a front elevational view of the work light of FIG. 8.

The broken line showing of a cord is for illustrative purposes only and forms no part of the claimed design.

1 Claim, 4 Drawing Sheets

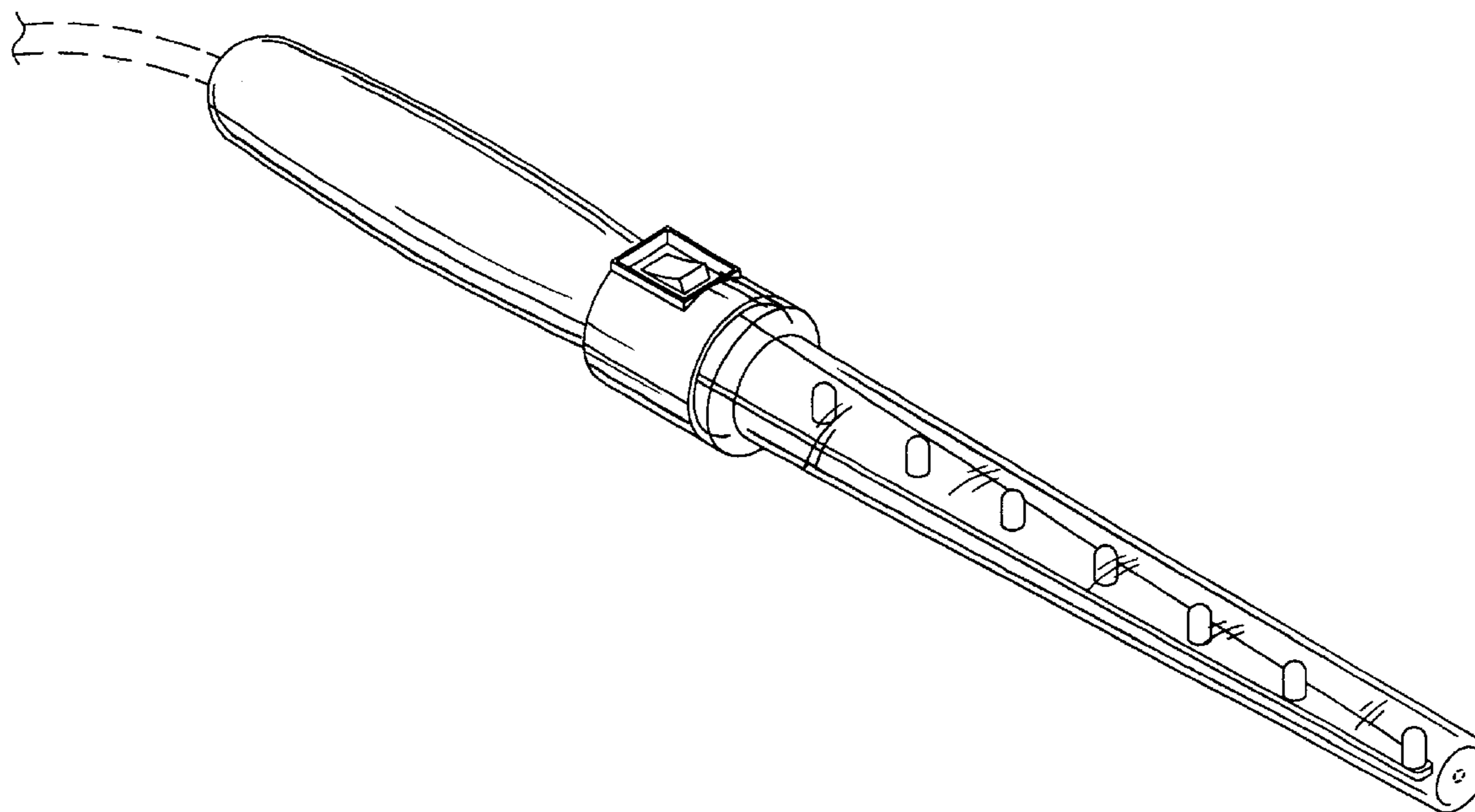

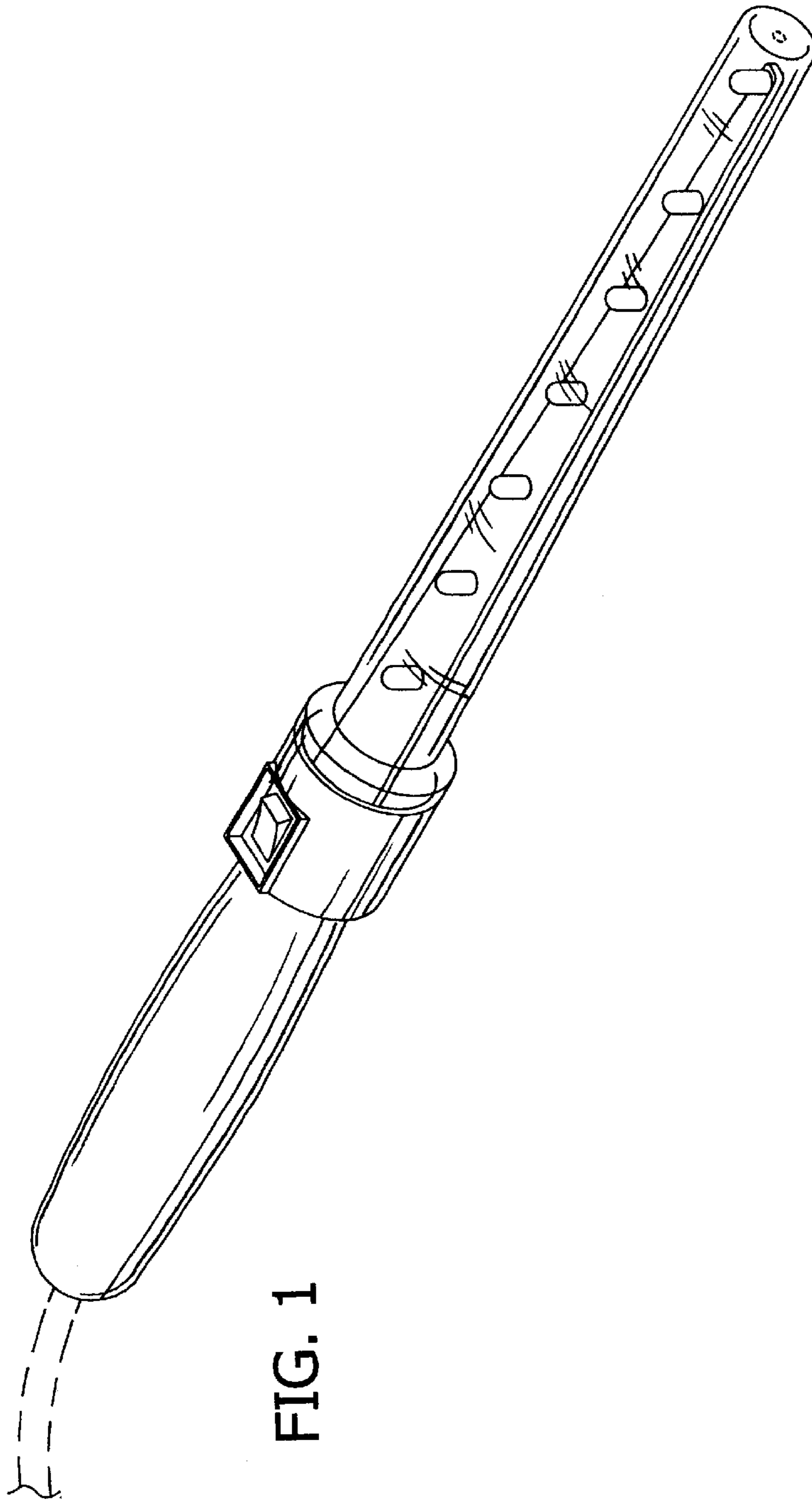

FIG. 1

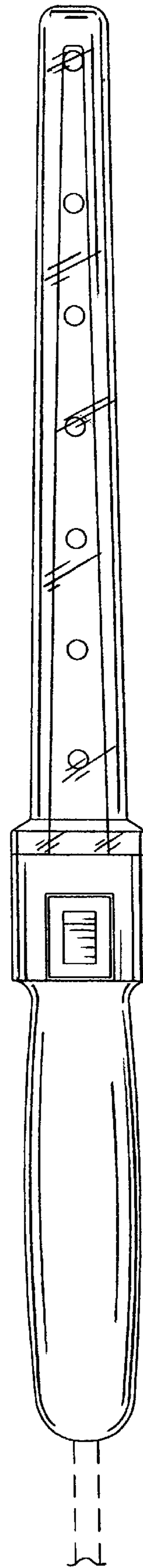

FIG. 2

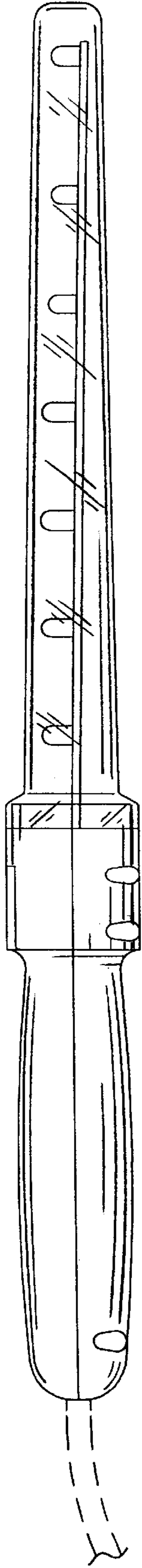

FIG. 3

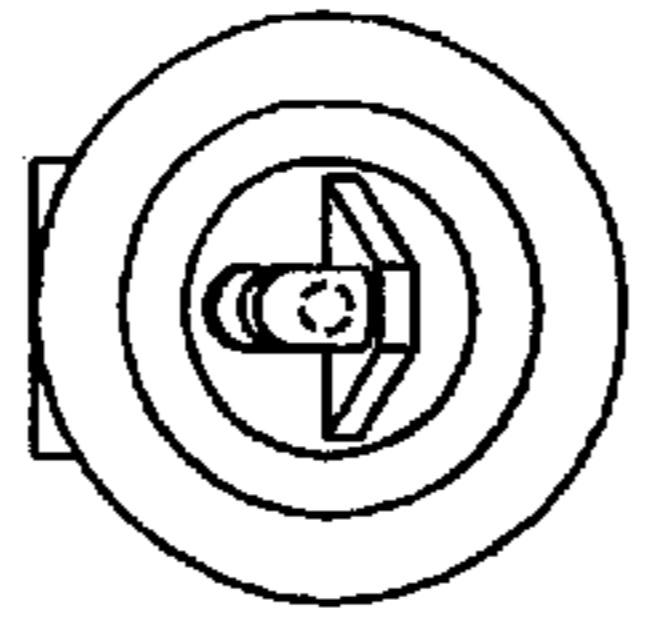

FIG. 7

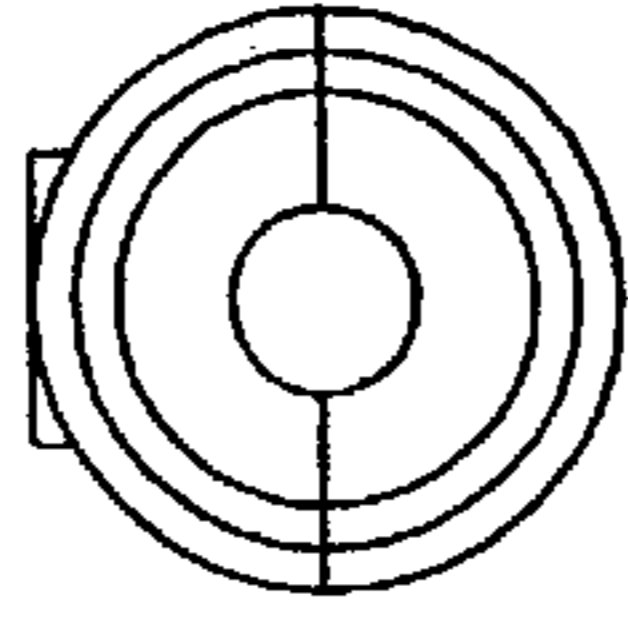

FIG. 6

FIG. 4

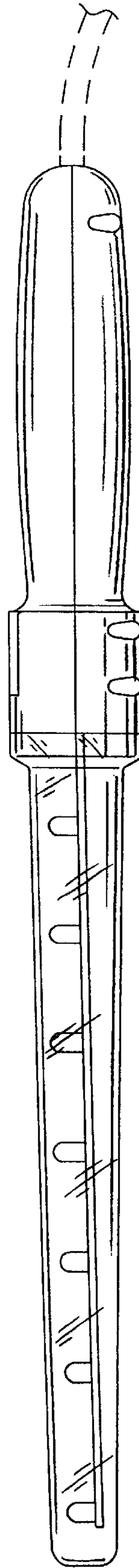
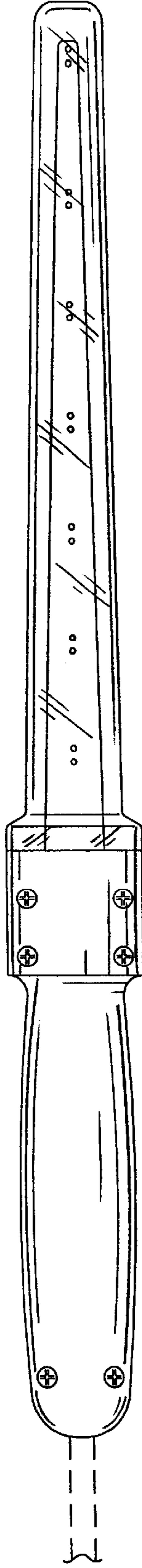

FIG. 5

FIG. 8

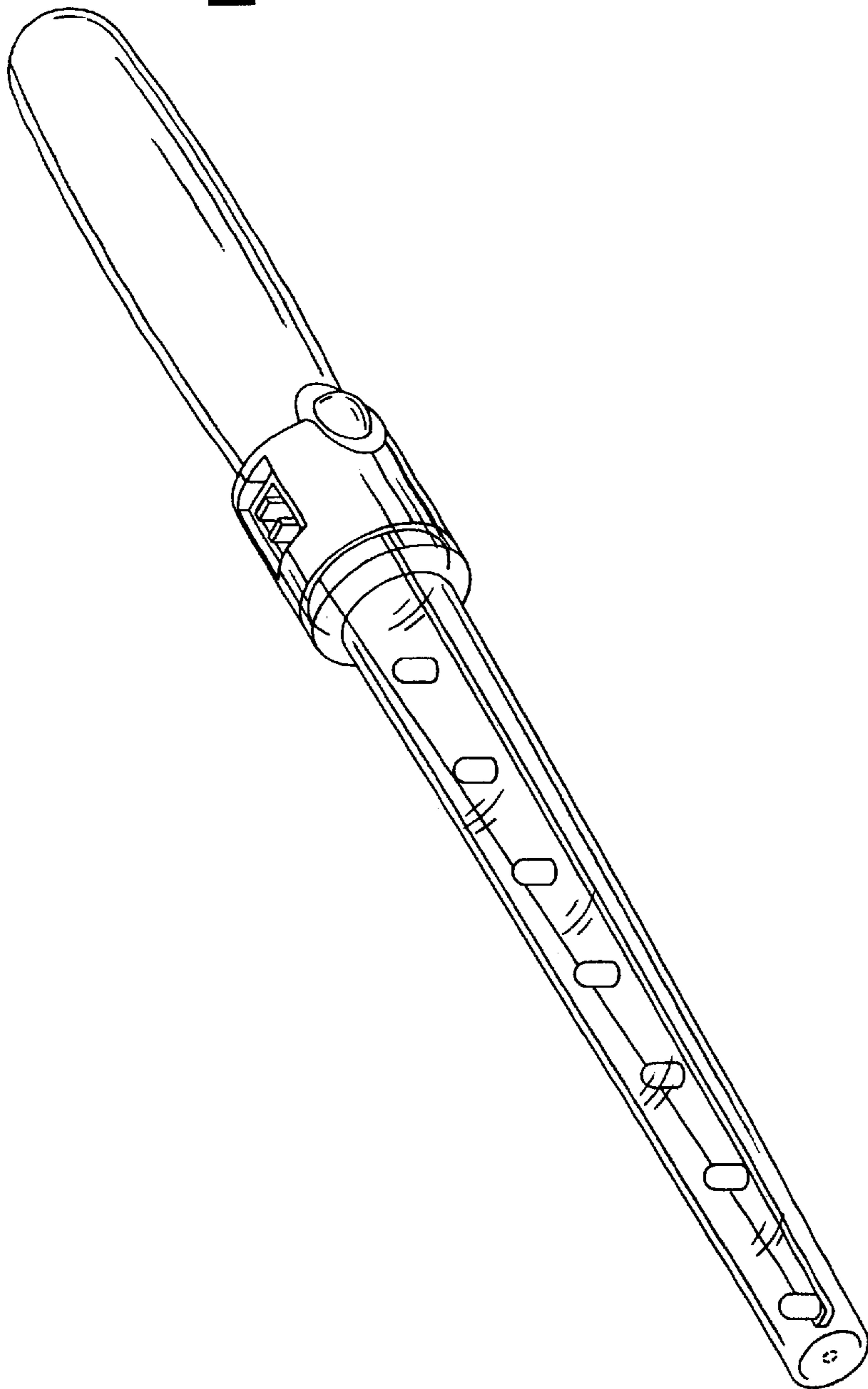
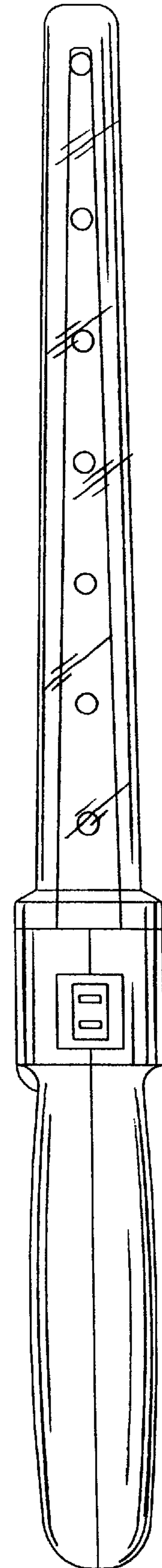

FIG. 9



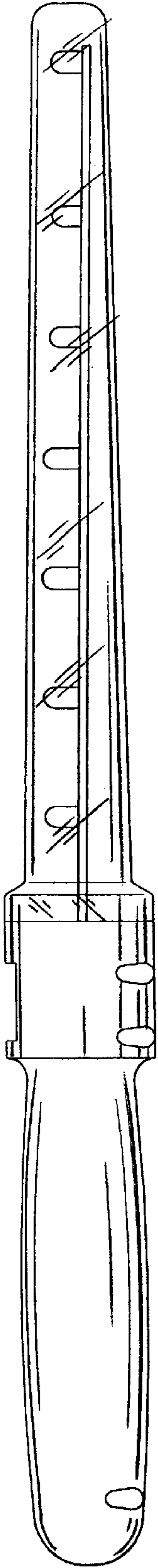

FIG. 10

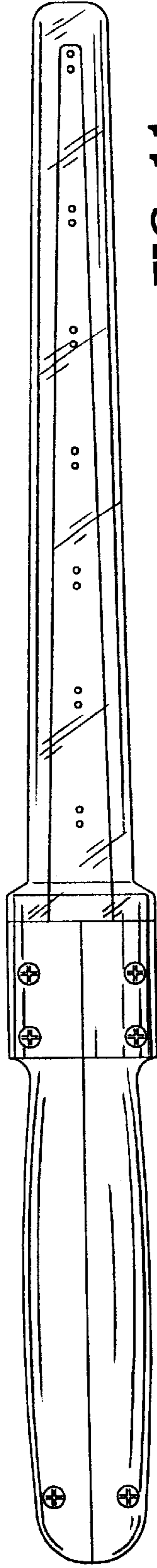

FIG. 11

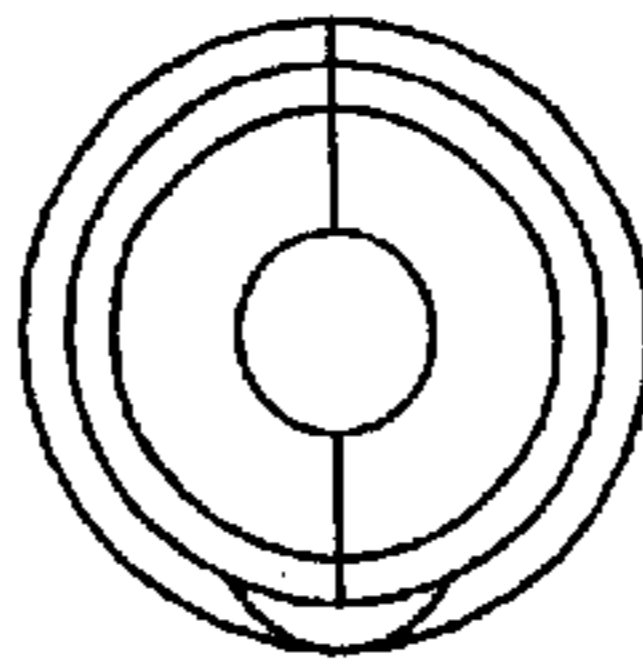

FIG. 13

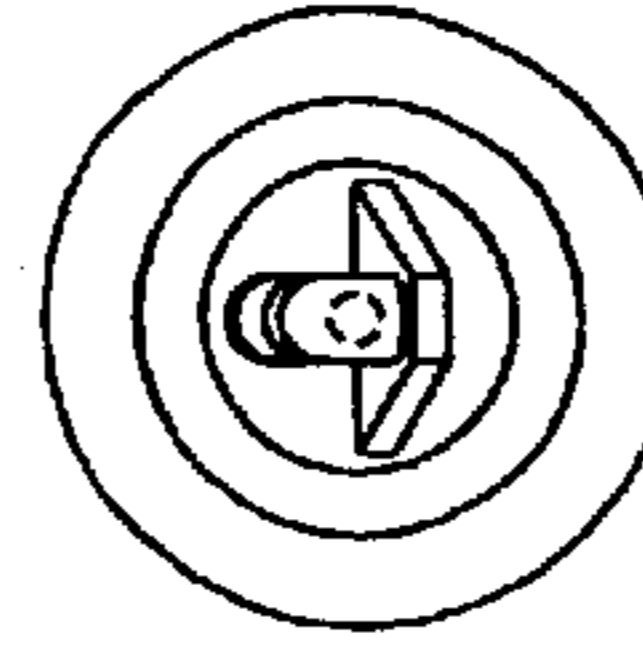

FIG. 14

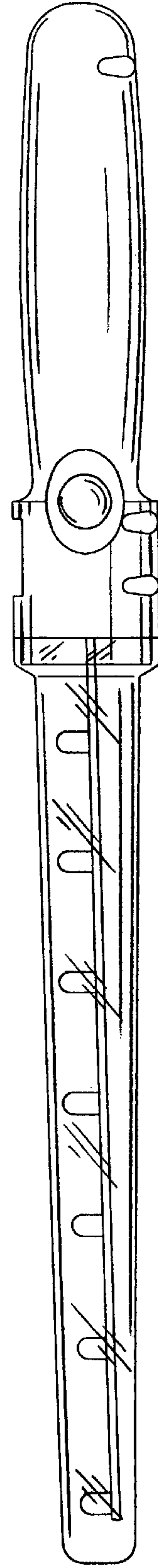

FIG. 12