



US00D521150S

(12) **United States Design Patent**  
**Kwok**

(10) **Patent No.:** **US D521,150 S**

(45) **Date of Patent:** **\*\* May 16, 2006**

(54) **SET OF DENTAL IMPRESSION TRAYS**

(76) Inventor: **Lloyd A. Kwok**, 423 Broadway, Suite 501, Burlingame, CA (US) 94030

(\*\*) Term: **14 Years**

(21) Appl. No.: **29/195,487**

(22) Filed: **Dec. 12, 2003**

(51) **LOC (8) Cl.** ..... **24-03**

(52) **U.S. Cl.** ..... **D24/181**

(58) **Field of Classification Search** ..... D18/14,  
D18/15, 19, 50, 52, 55, 56; 156/361, 384,  
156/5; 235/385, 432, 487; 346/136; 347/171,  
347/218, 222; 400/613, 613.4, 691-694,  
400/990.1; 361/884; D14/426, 430  
See application file for complete search history.

(56) **References Cited**

U.S. PATENT DOCUMENTS

D266,269	S	*	9/1982	Werrin	.....	D24/181
D302,463	S	*	7/1989	Wolfe	.....	D24/181
5,513,985	A	*	5/1996	Robertson	.....	433/38
D403,771	S	*	1/1999	Werrin	.....	D24/181
D413,386	S	*	8/1999	Werrin	.....	D24/181
6,450,808	B1	*	9/2002	Pelerin	.....	433/38
D464,138	S	*	10/2002	Werrin	.....	D24/181
2003/0138754	A1	*	7/2003	DiMarino et al.	.....	433/37
2004/0101803	A1	*	5/2004	Tucker et al.	.....	433/38
2004/0219475	A1	*	11/2004	DiMarino et al.	.....	433/38

\* cited by examiner

*Primary Examiner*—Charles A. Rademaker

(74) *Attorney, Agent, or Firm*—Thomas M. Freiburger

(57) **CLAIM**

The ornamental design for a set of dental impression trays, as shown and described.

**DESCRIPTION**

FIG. 1 is a perspective view of the left tray of a set of dental impression trays showing my new design;

FIG. 2 is a top plan view thereof with the right tray represented in broken lines as environment;

FIG. 3 is an inside edge elevation thereof;

FIG. 4 is an outside edge elevation thereof;

FIG. 5 is an end elevation thereof with the right tray represented in broken lines as environment;

FIG. 6 is an elevation of the end opposite that shown in FIG. 5;

FIG. 7 is a perspective view of the right tray;

FIG. 8 is a top plan view thereof;

FIG. 9 is an inside edge elevation thereof;

FIG. 10 is an outside edge elevation thereof;

FIG. 11 is an end elevation thereof;

FIG. 12 is an end elevation of the end opposite that shown in FIG. 11; and,

FIG. 13 is a top plan view of the set of dental impression trays.

The broken lines shown in FIGS. 2 and 5 are for illustrative purposes only and form no part of the claimed design.

**1 Claim, 2 Drawing Sheets**

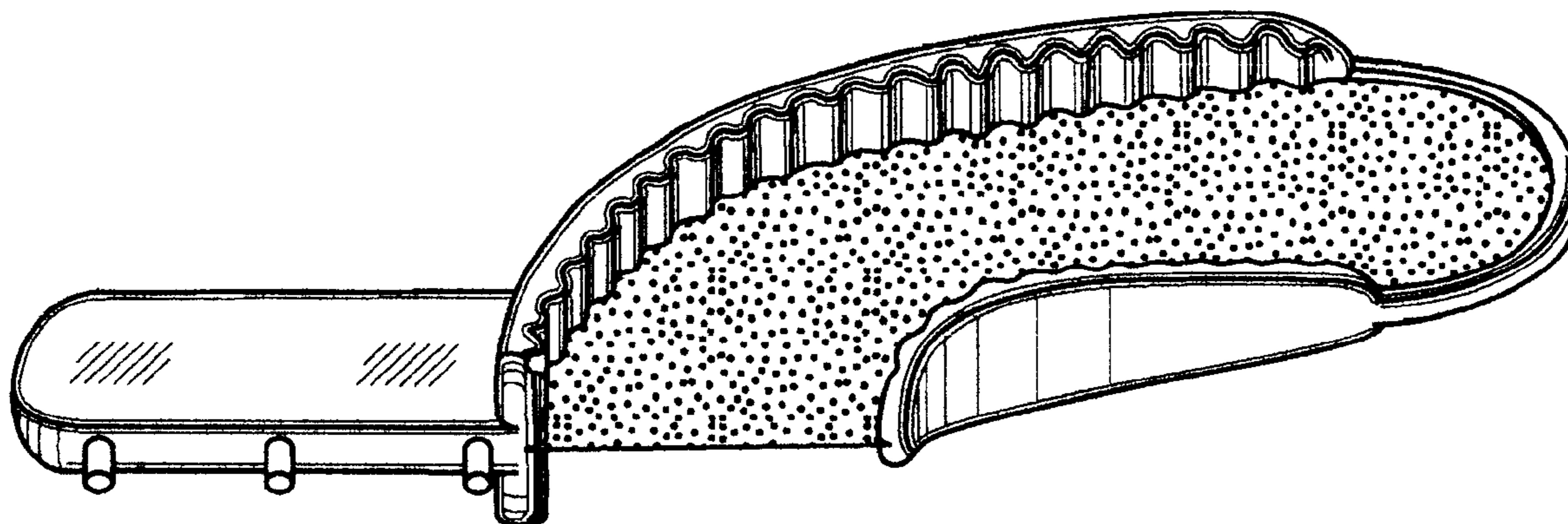

FIG. 1

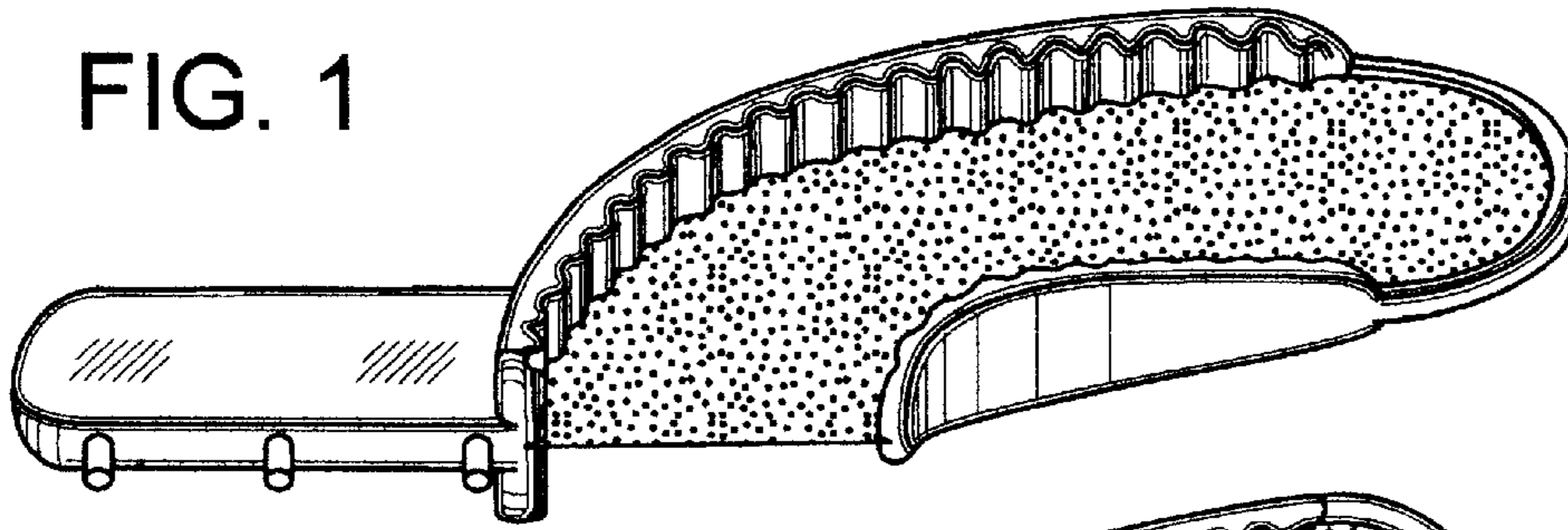

FIG. 2

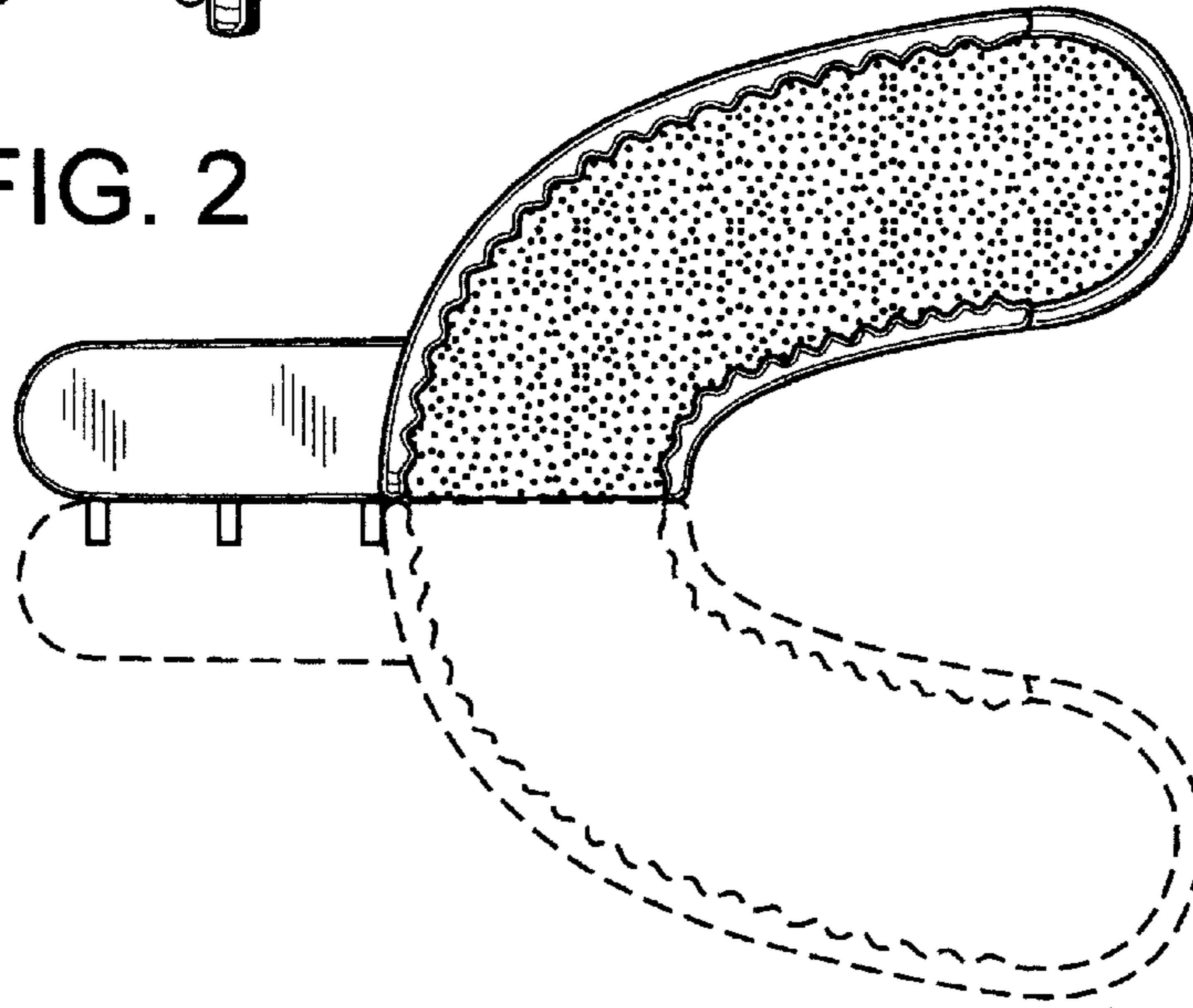

FIG. 3

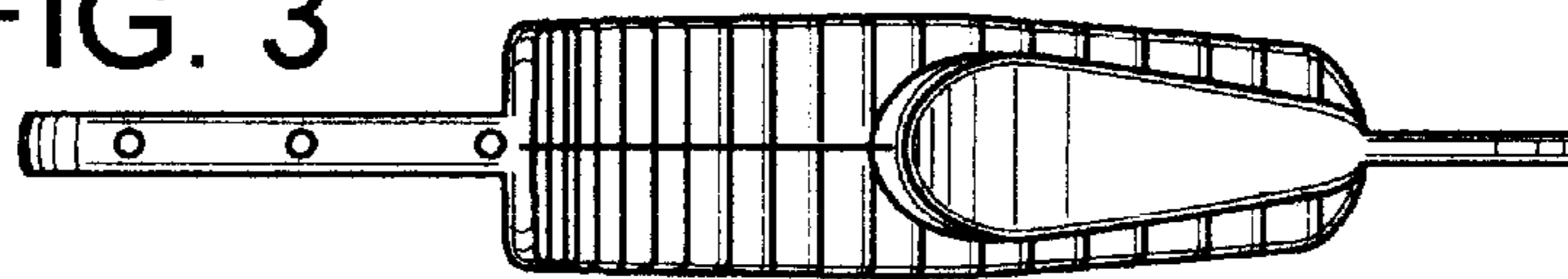

FIG. 4

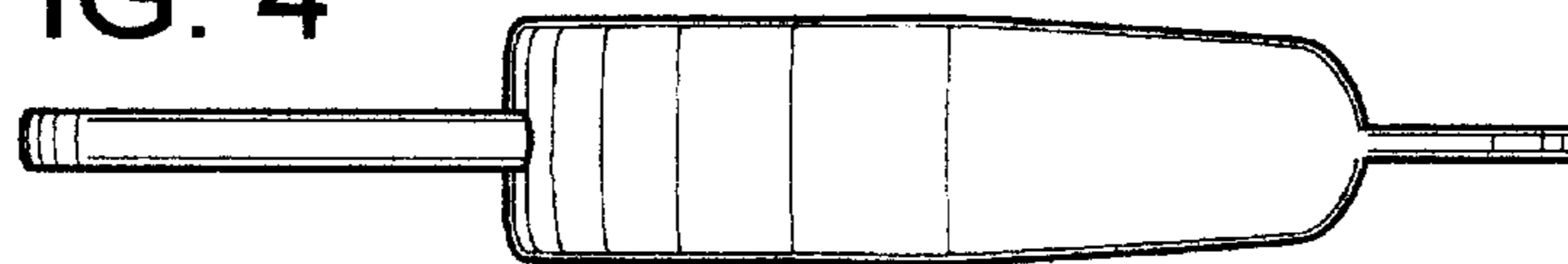

FIG. 5

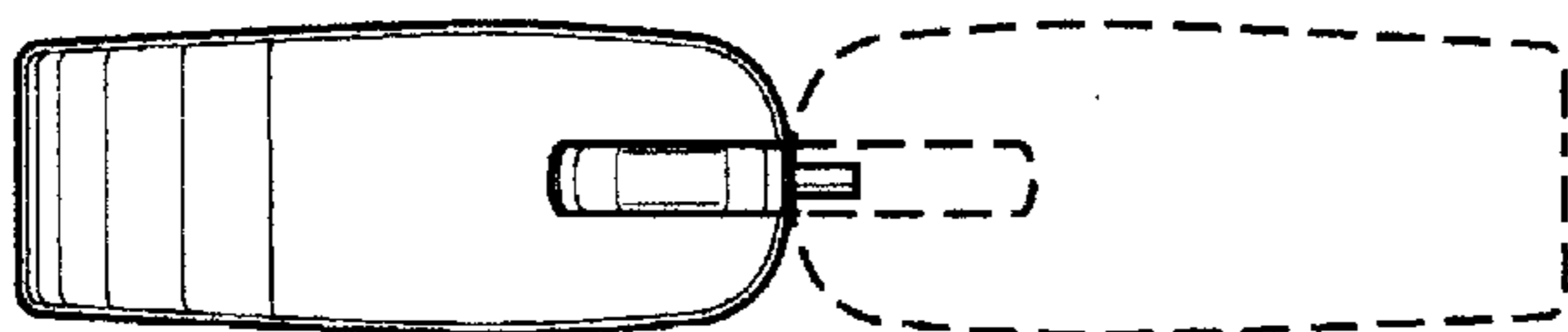
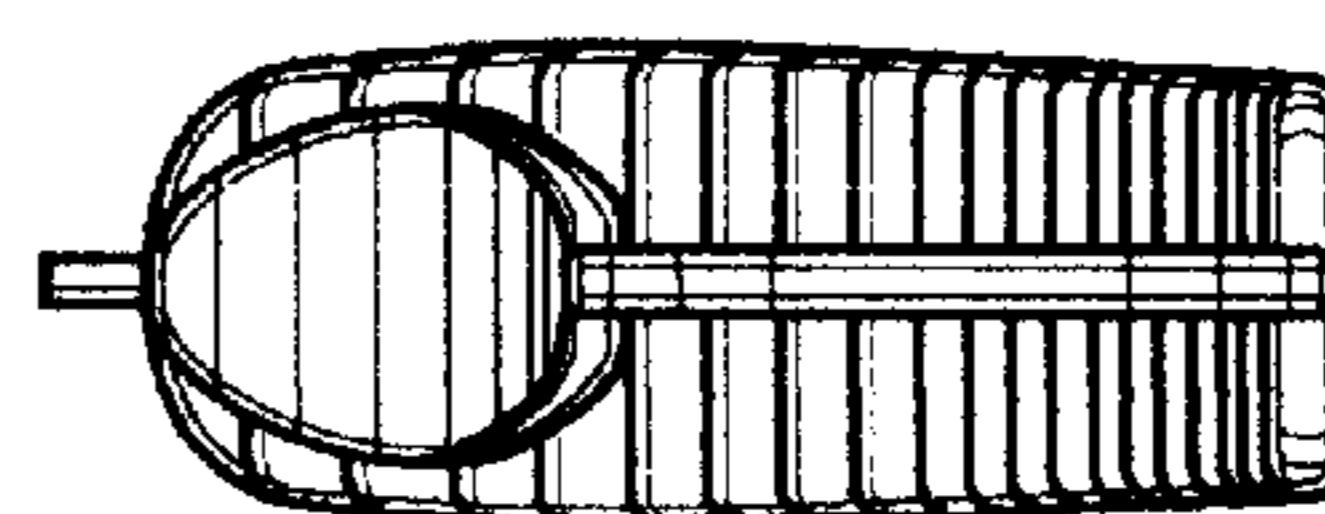

FIG. 6



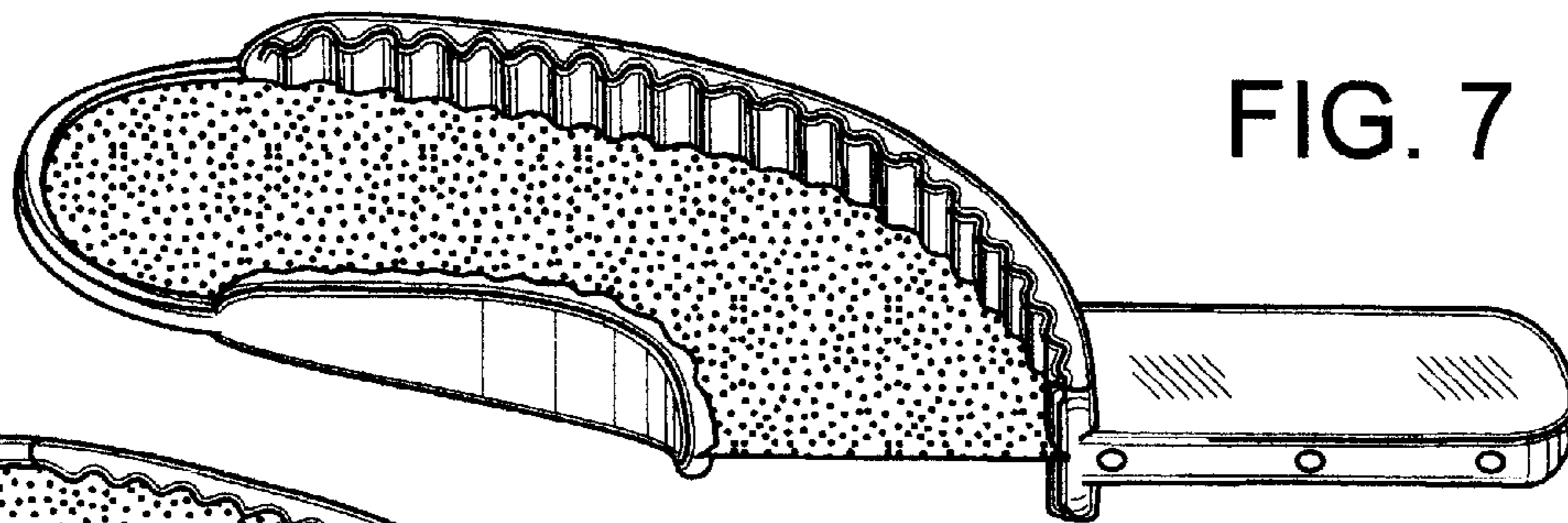

FIG. 7

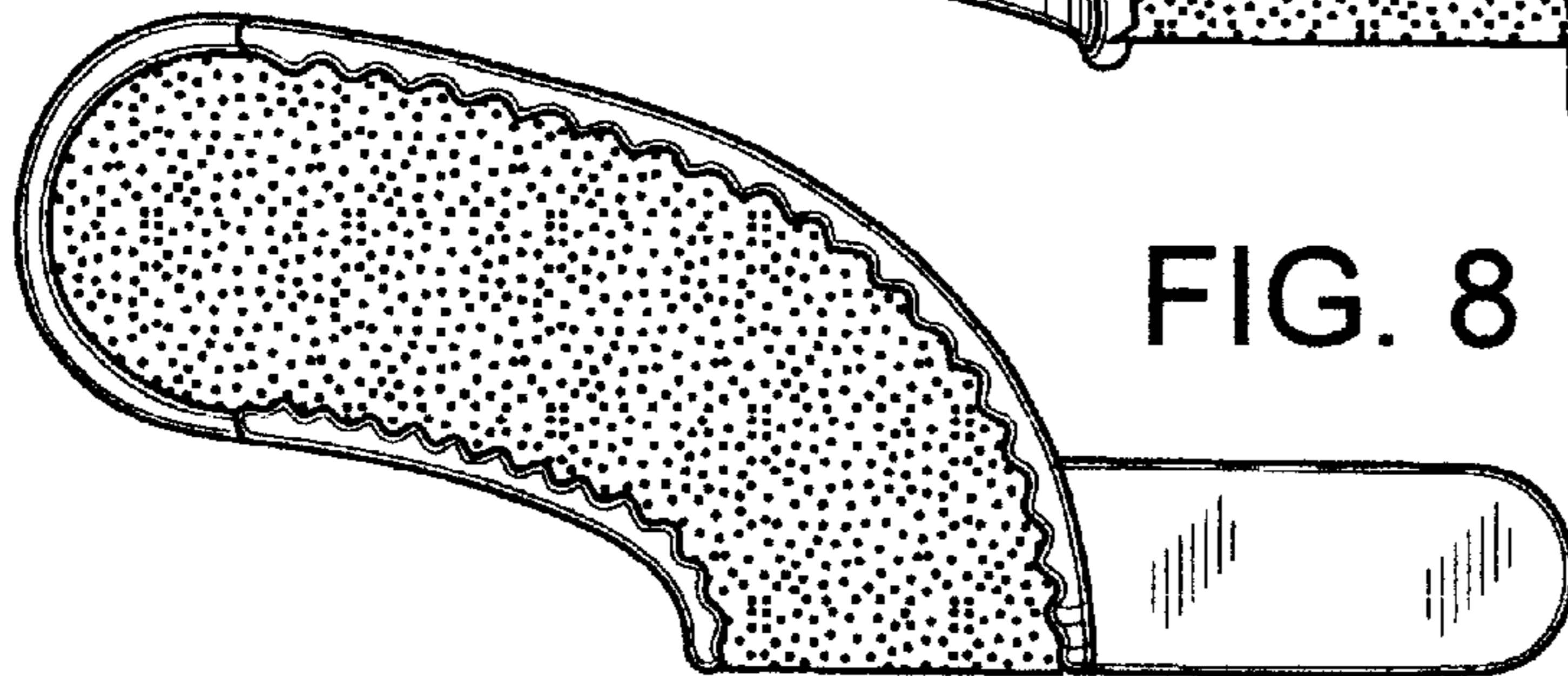

FIG. 8

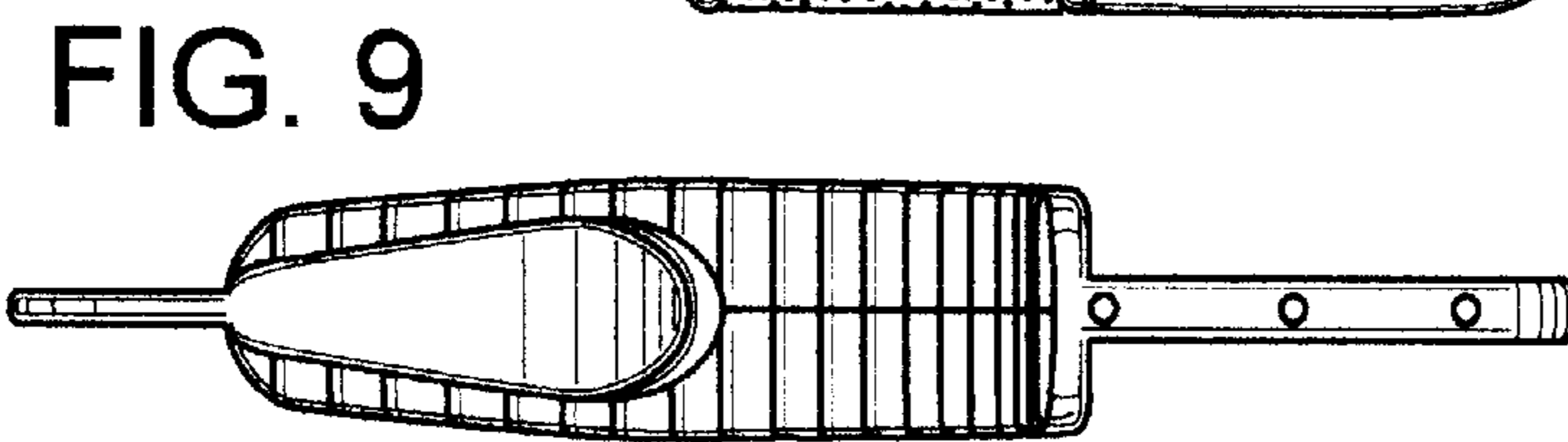

FIG. 9

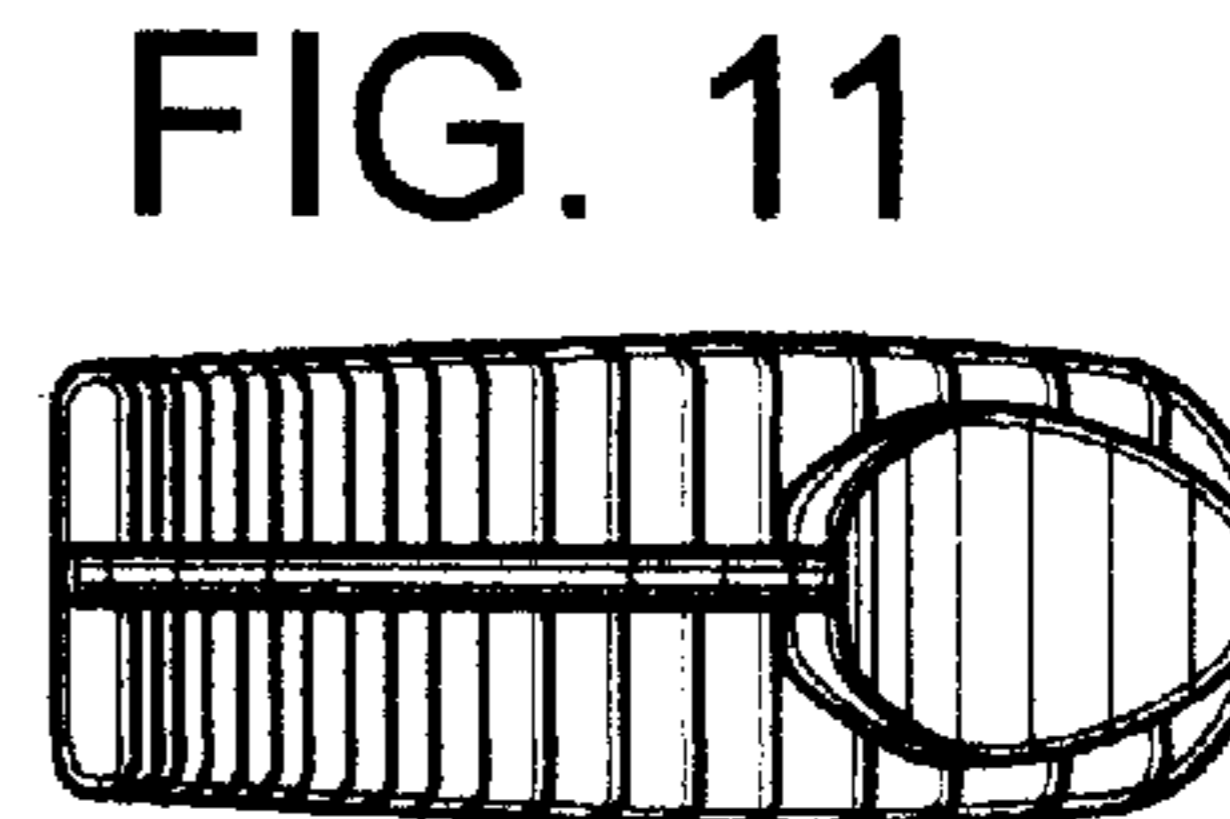

FIG. 11

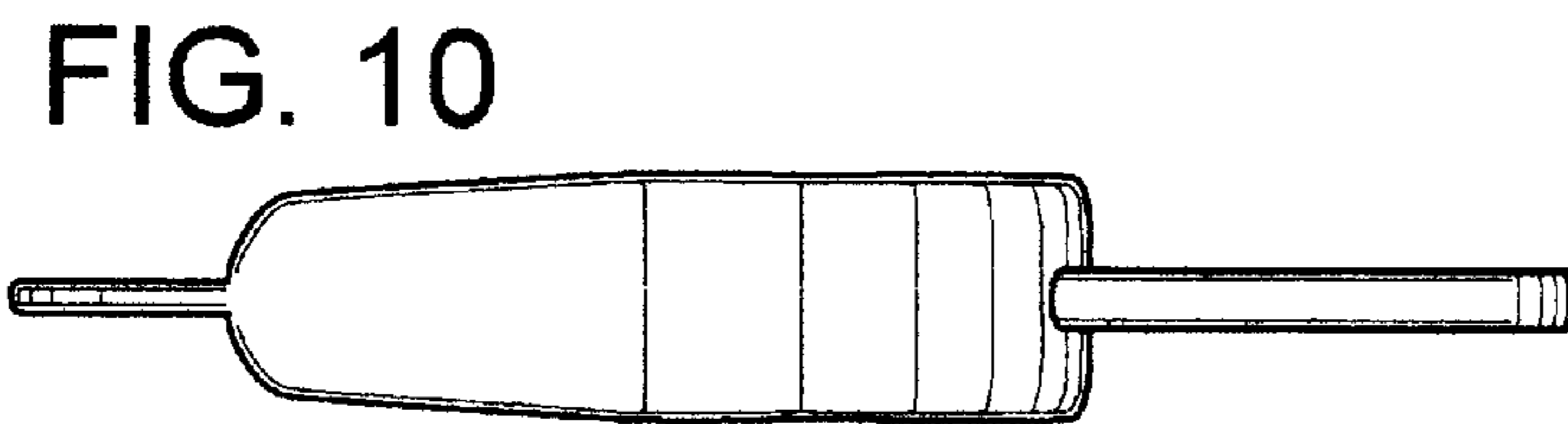

FIG. 10

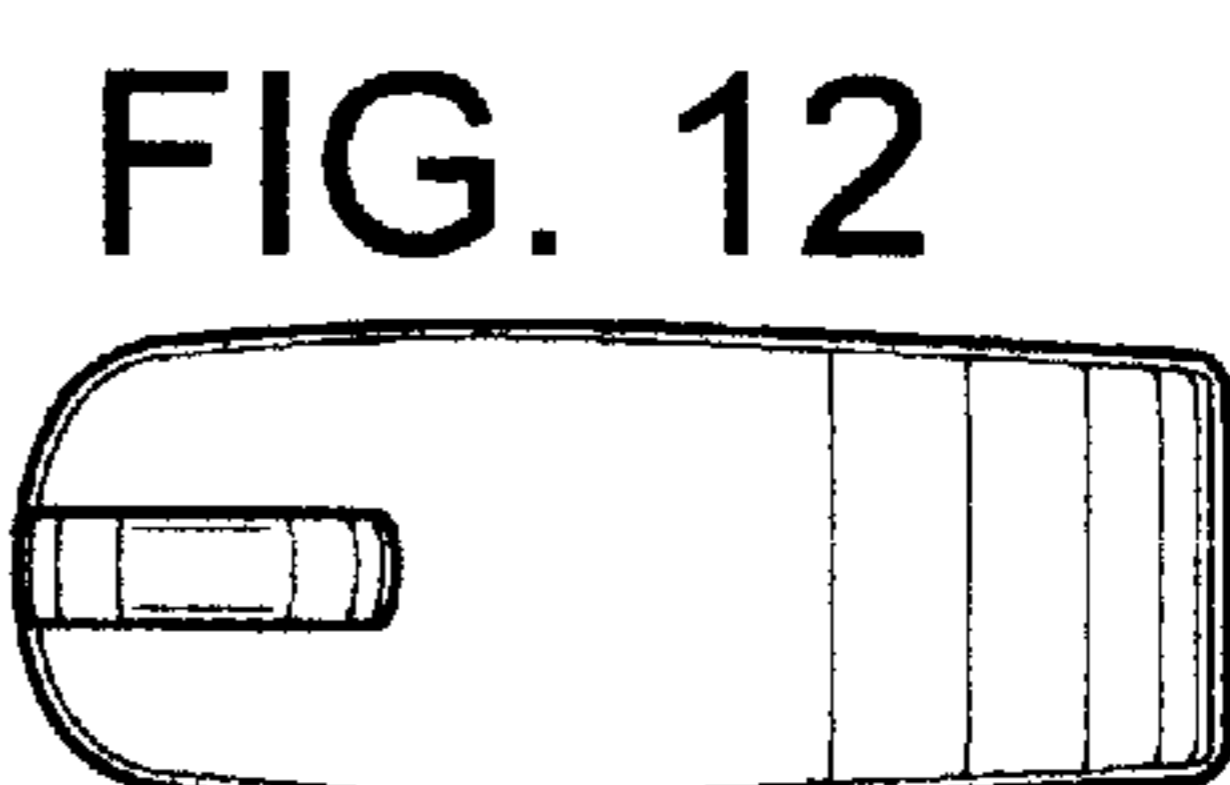

FIG. 12

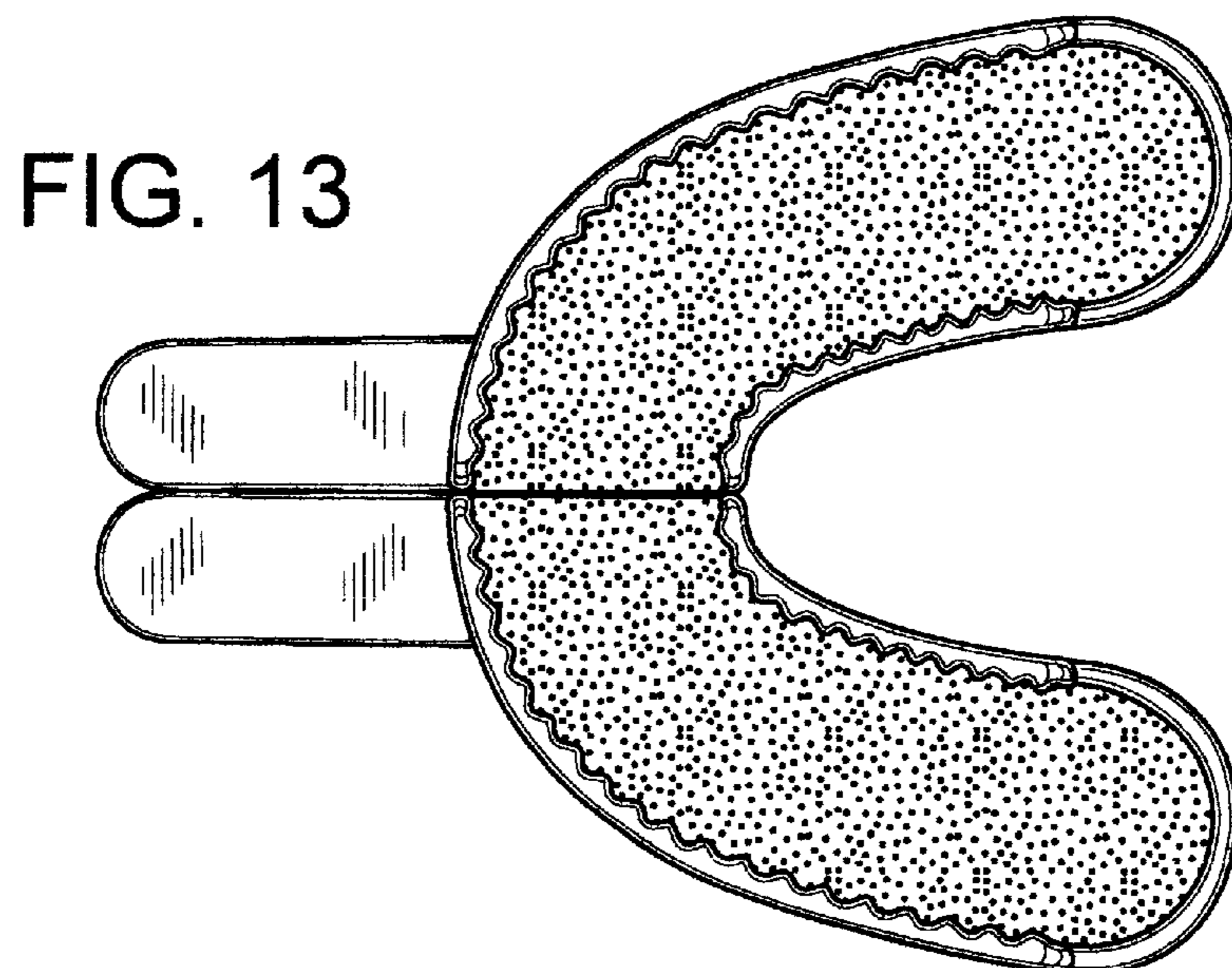

FIG. 13