

US00D521090S

(12) **United States Design Patent**  
**Burrows**

(10) **Patent No.:** **US D521,090 S**

(45) **Date of Patent:** **\*\* May 16, 2006**

- (54) **WOOD-TYPE GOLF CLUB HEAD**
- (75) Inventor: **Bruce D. Burrows**, Valencia, CA (US)
- (73) Assignee: **BGI Acquisition, LLC**, Indianapolis, IN (US)
- (\*\*) Term: **14 Years**

- (21) Appl. No.: **29/218,354**
- (22) Filed: **Nov. 30, 2004**
- (51) **LOC (8) Cl.** ..... **21-02**
- (52) **U.S. Cl.** ..... **D21/752**
- (58) **Field of Classification Search** ..... D21/733,  
D21/752, 759; 473/324-331, 343-346  
See application file for complete search history.

(56) **References Cited**

U.S. PATENT DOCUMENTS

D344,998 S	*	3/1994	Greene	.....	D21/752
D352,983 S	*	11/1994	Williams, Jr.	.....	D21/752
D359,781 S	*	6/1995	Allen	.....	D21/749
D367,094 S	*	2/1996	Williams, Jr.	.....	D21/752
D390,295 S	*	2/1998	Burrows	.....	D21/752
D413,642 S	*	9/1999	Burrows	.....	D21/752
D413,953 S	*	9/1999	Burrows	.....	D21/752

\* cited by examiner

*Primary Examiner*—Mitchell Siegel  
(74) *Attorney, Agent, or Firm*—Ice Miller LLP

(57) **CLAIM**

The ornamental design for a wood-type golf club head, as shown and described.

**DESCRIPTION**

FIG. 1 is a perspective view showing the front, top and toe end of a wood-type golf club head embodying the new design;

FIG. 2 is a front elevation view thereof;

FIG. 3 is a rear elevation view thereof;

FIG. 4 is a toe end elevation view thereof;

FIG. 5 is a heel end elevation view thereof;

FIG. 6 is a top plan view thereof;

FIG. 7 is a bottom plan view thereof;

FIG. 8 is a fragmented sectional view taken generally on the line 8—8 of FIG. 7;

FIG. 9 is a bottom plan view of an alternative form of the invention, the front, back, left, right and top sides thereof being identical to FIGS. 2-7; and,

FIG. 10 is a fragmented sectional view taken generally on the line 10—10 of FIG. 9.

The dotted line depiction of a faceplate groove pattern is for illustrative purposes only and forms no part of the claimed design.

**1 Claim, 4 Drawing Sheets**

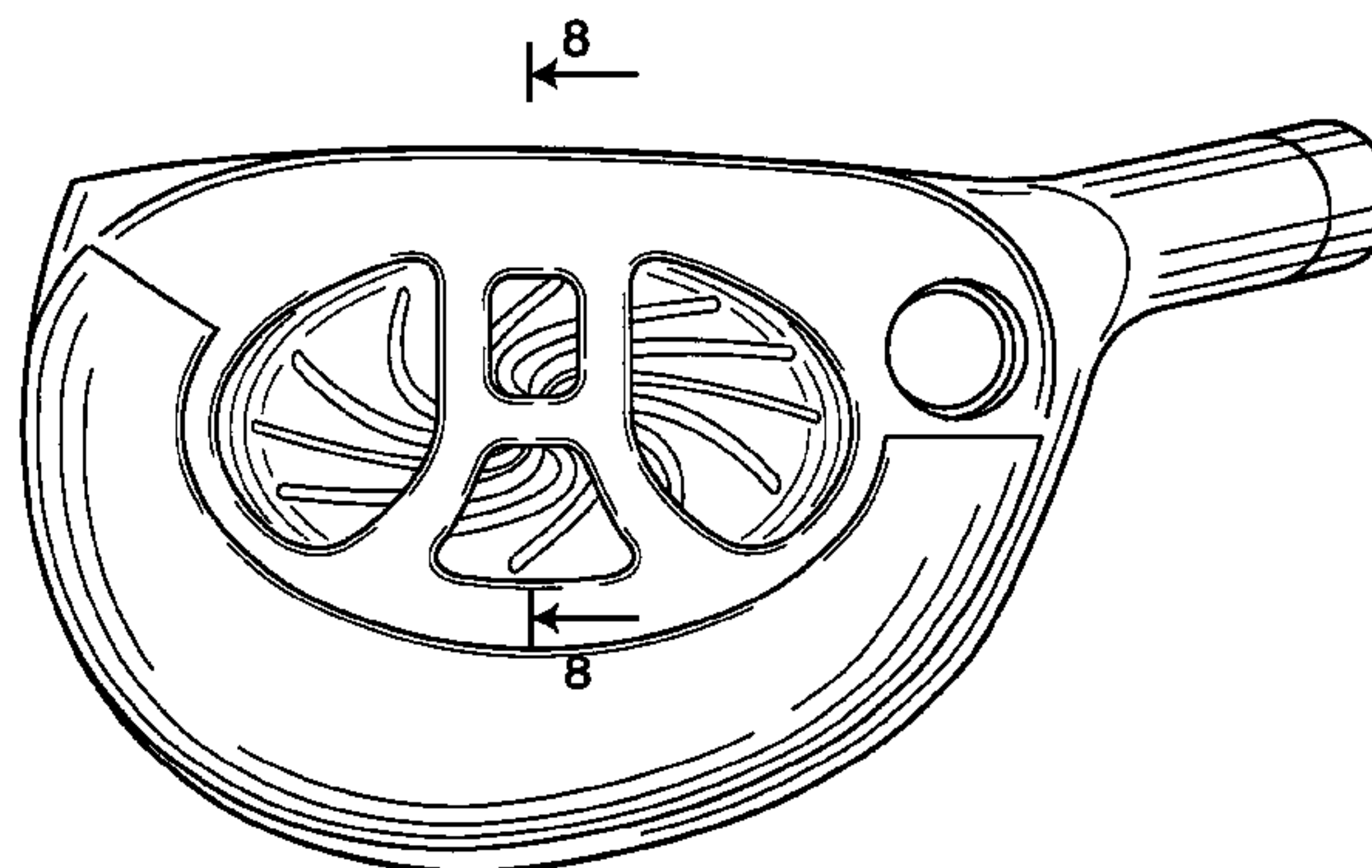
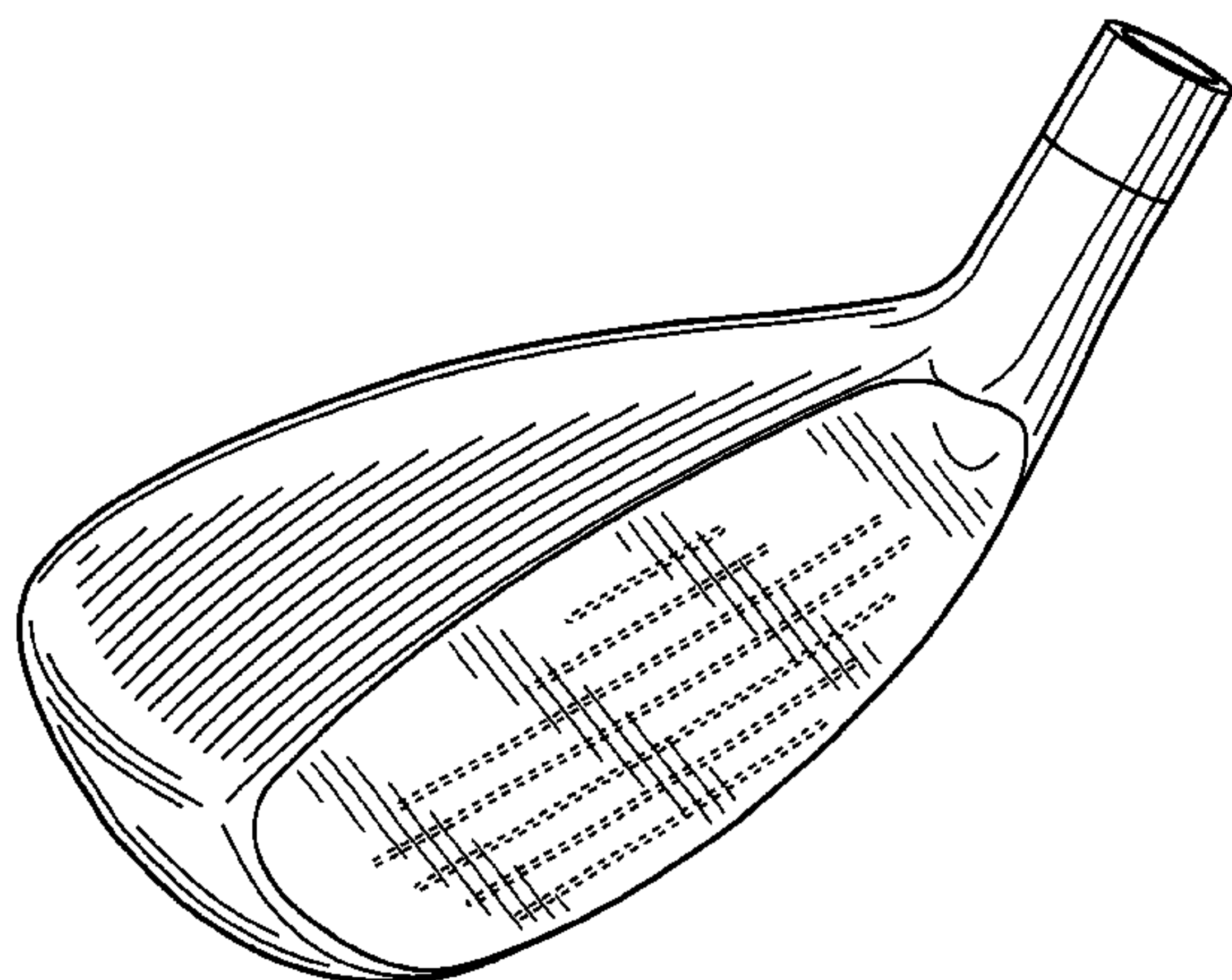

FIG. 1

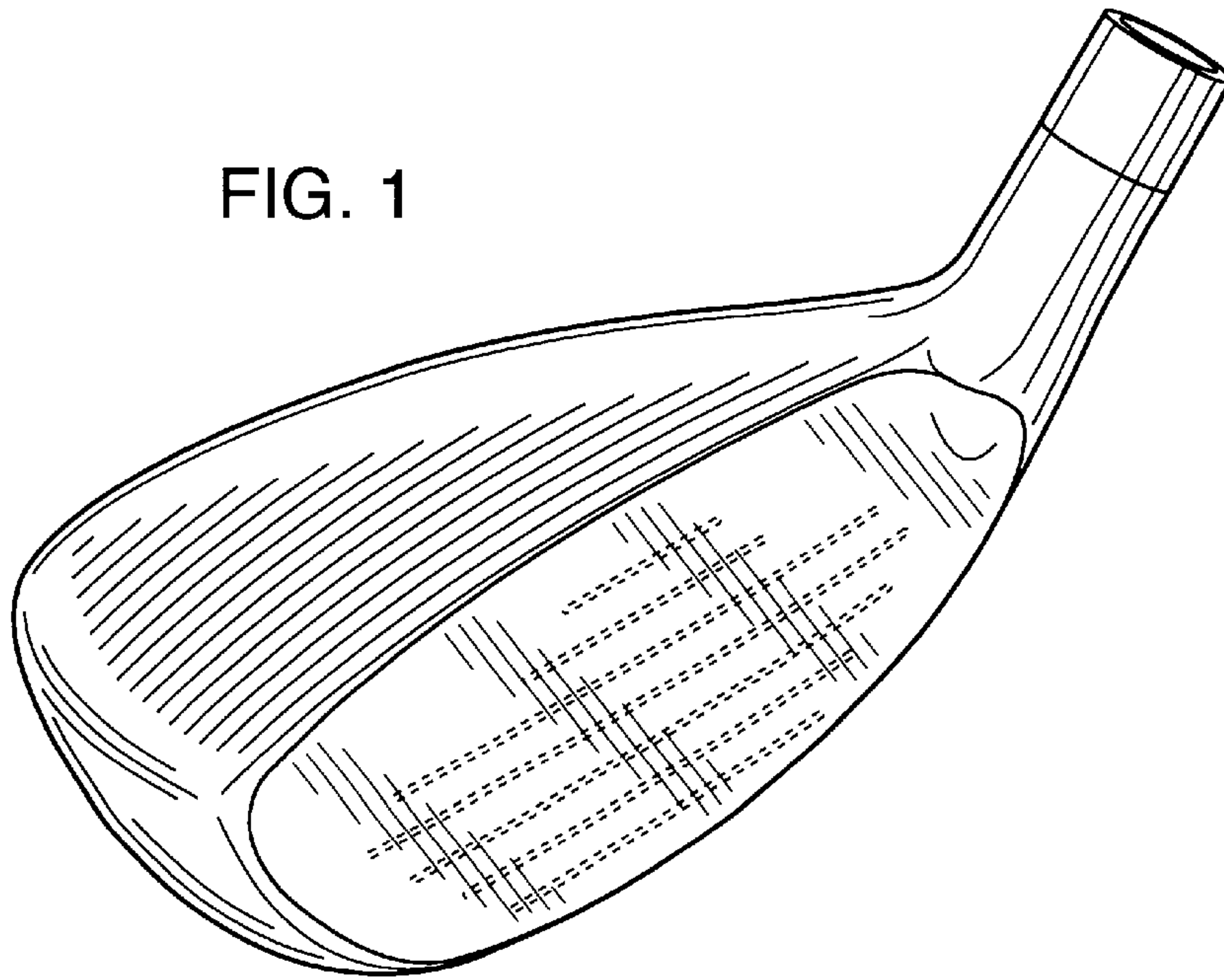

FIG. 2

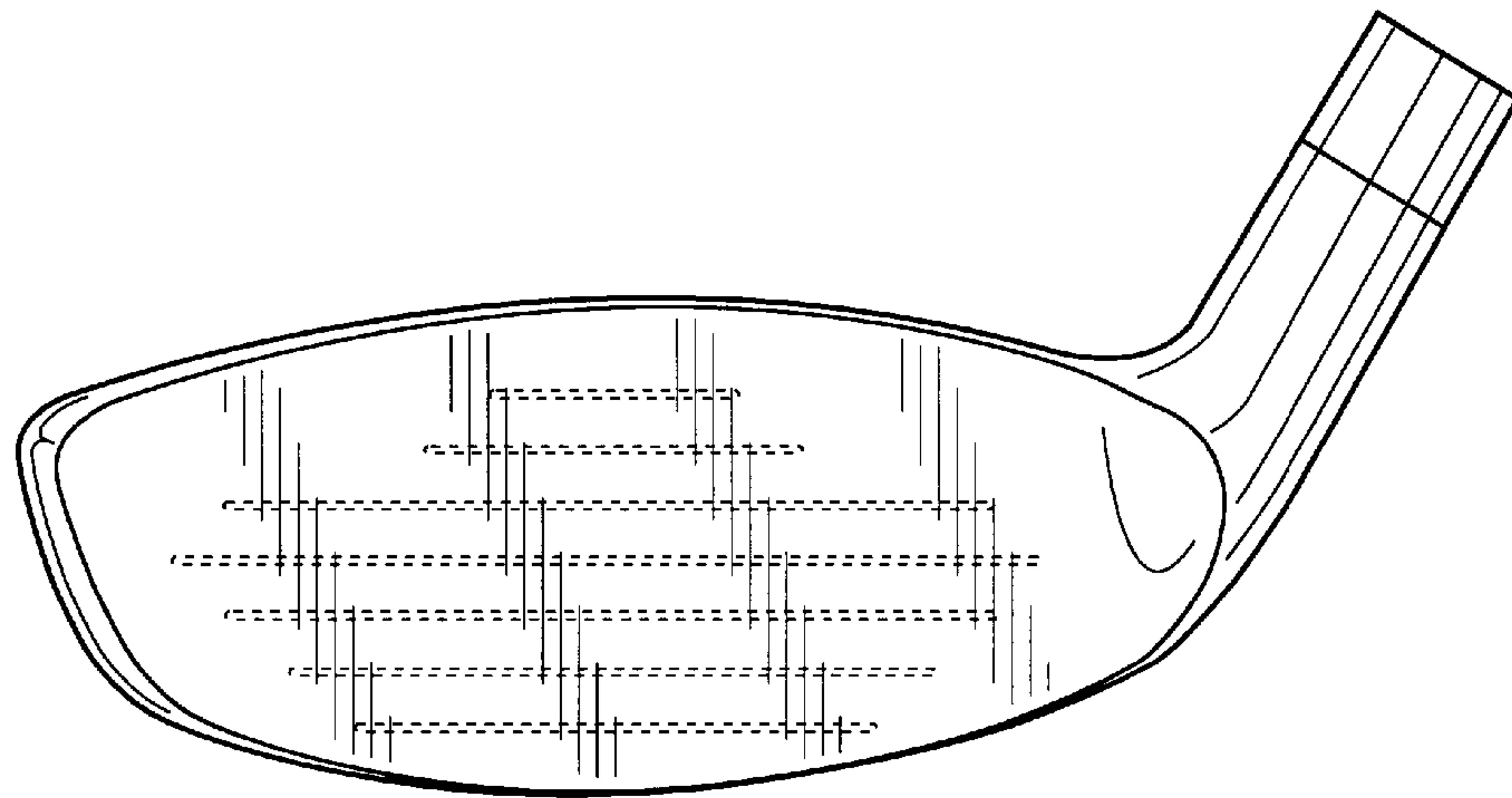

FIG. 3



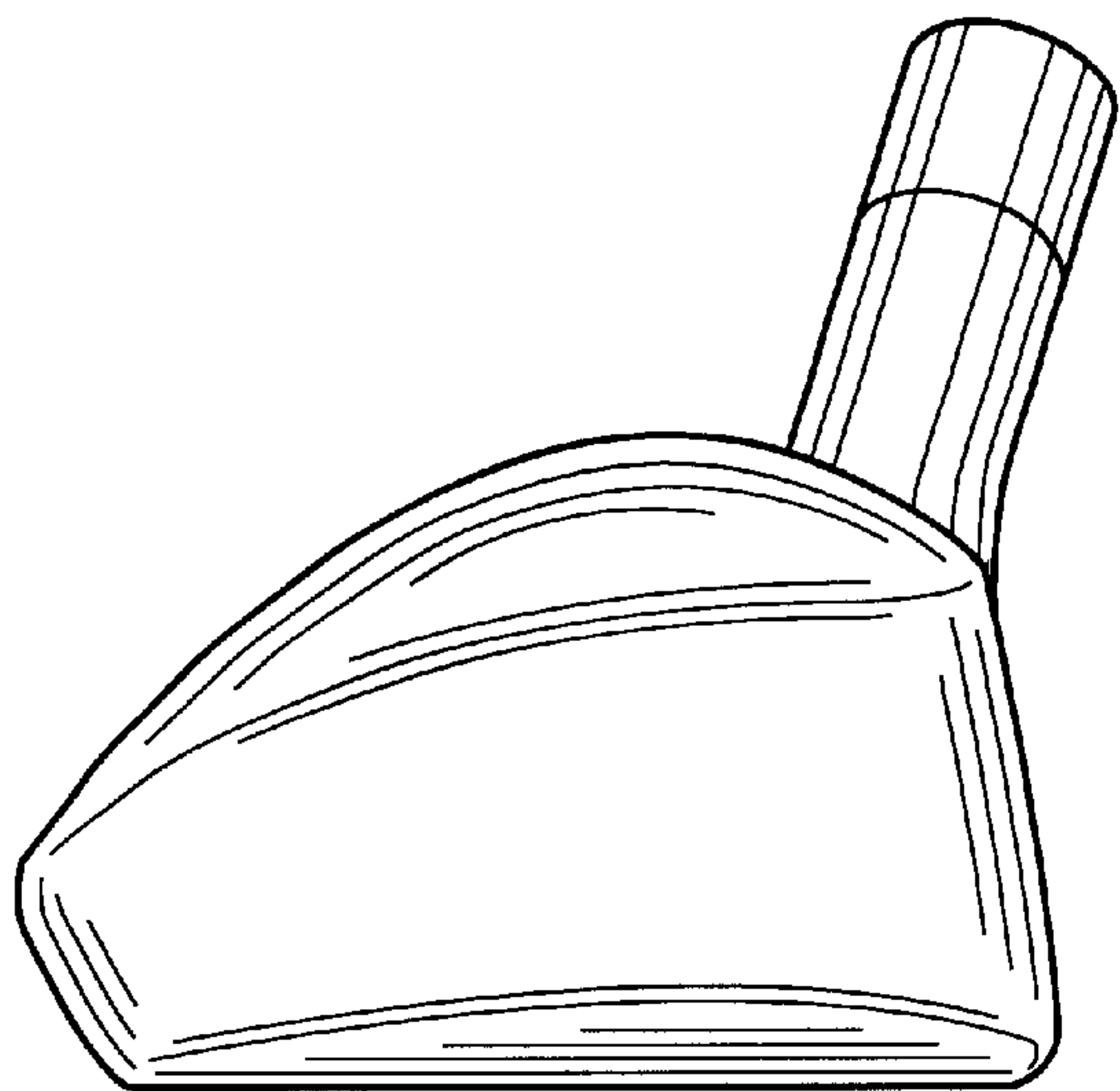

FIG. 4

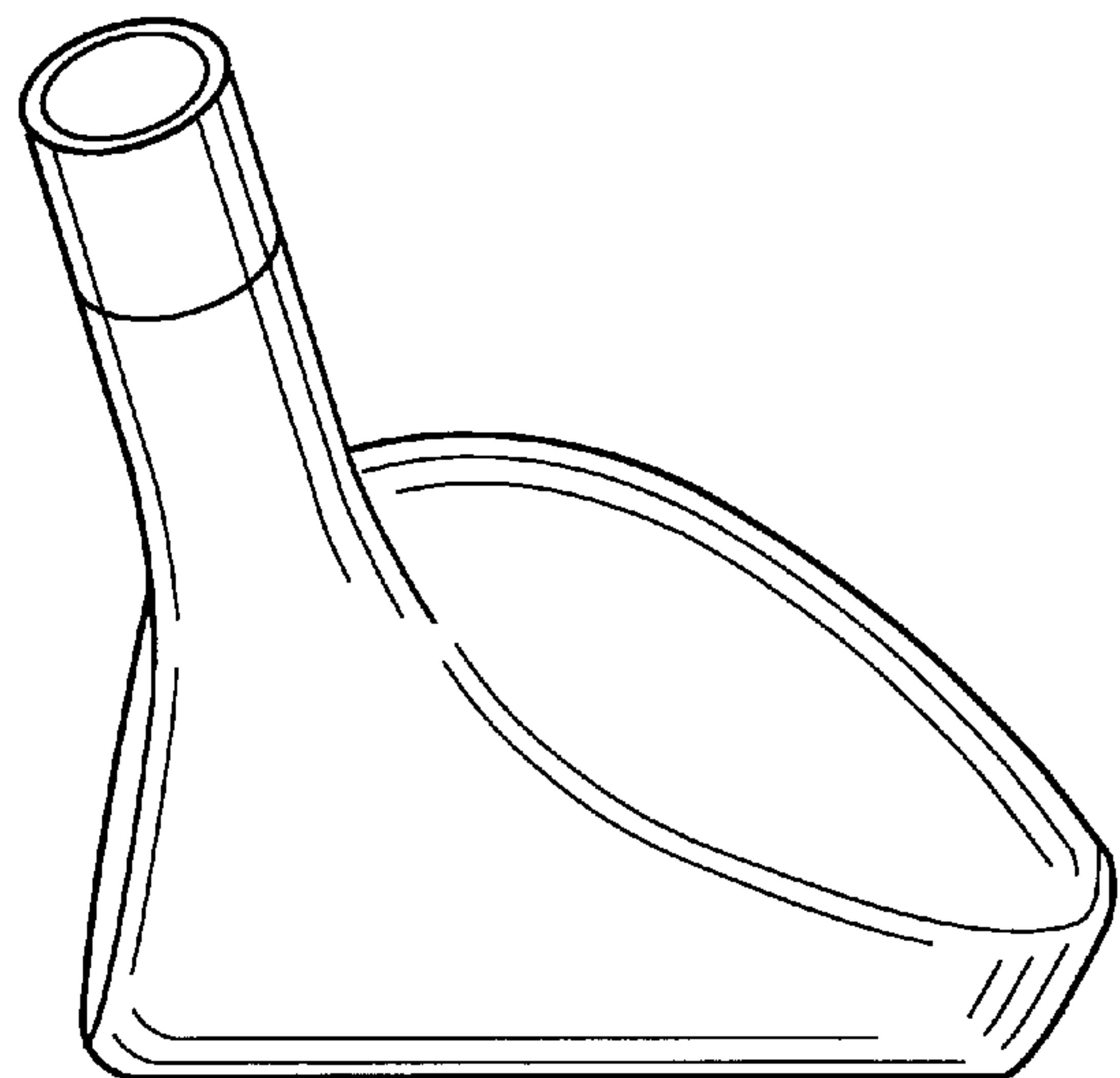

FIG. 5

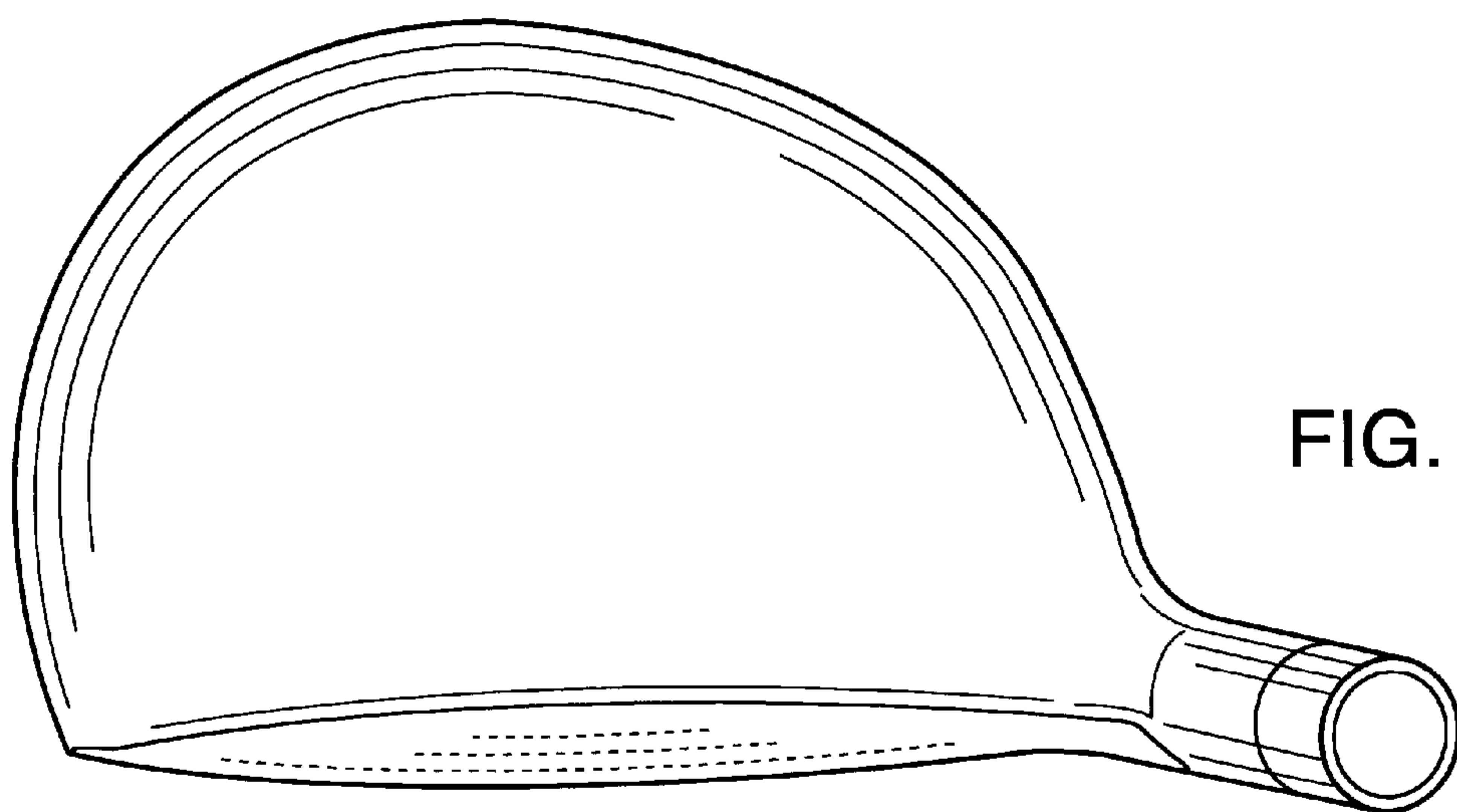

FIG. 6



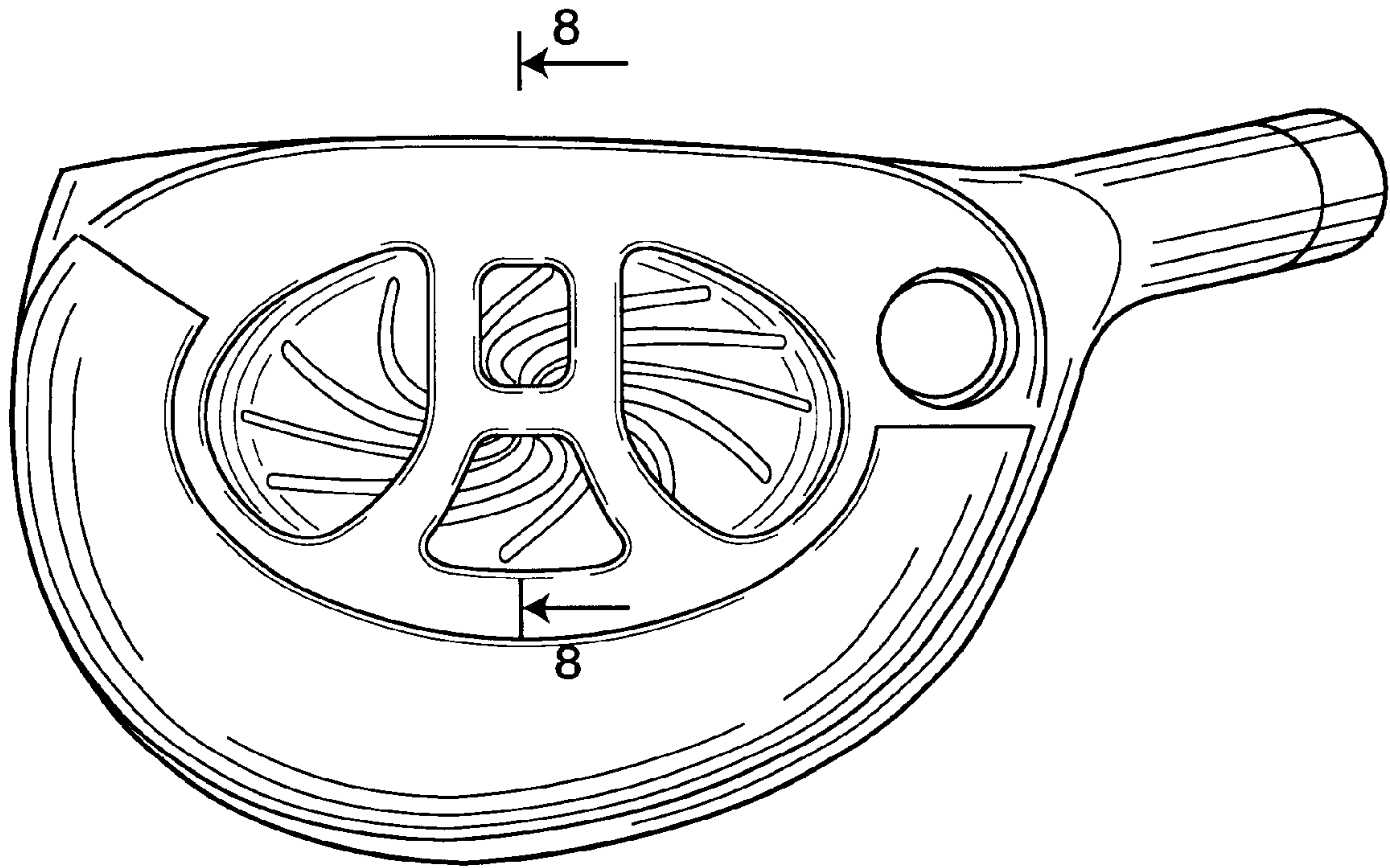

FIG. 7

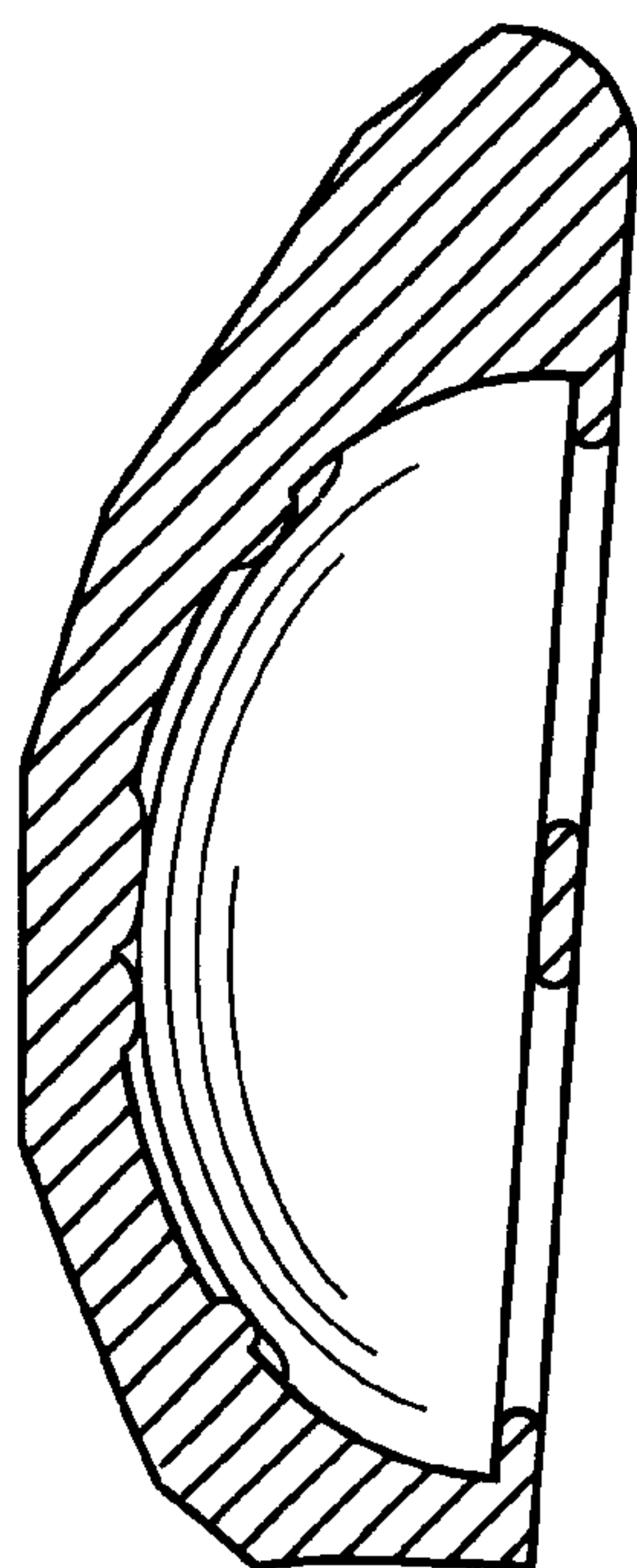

FIG. 8

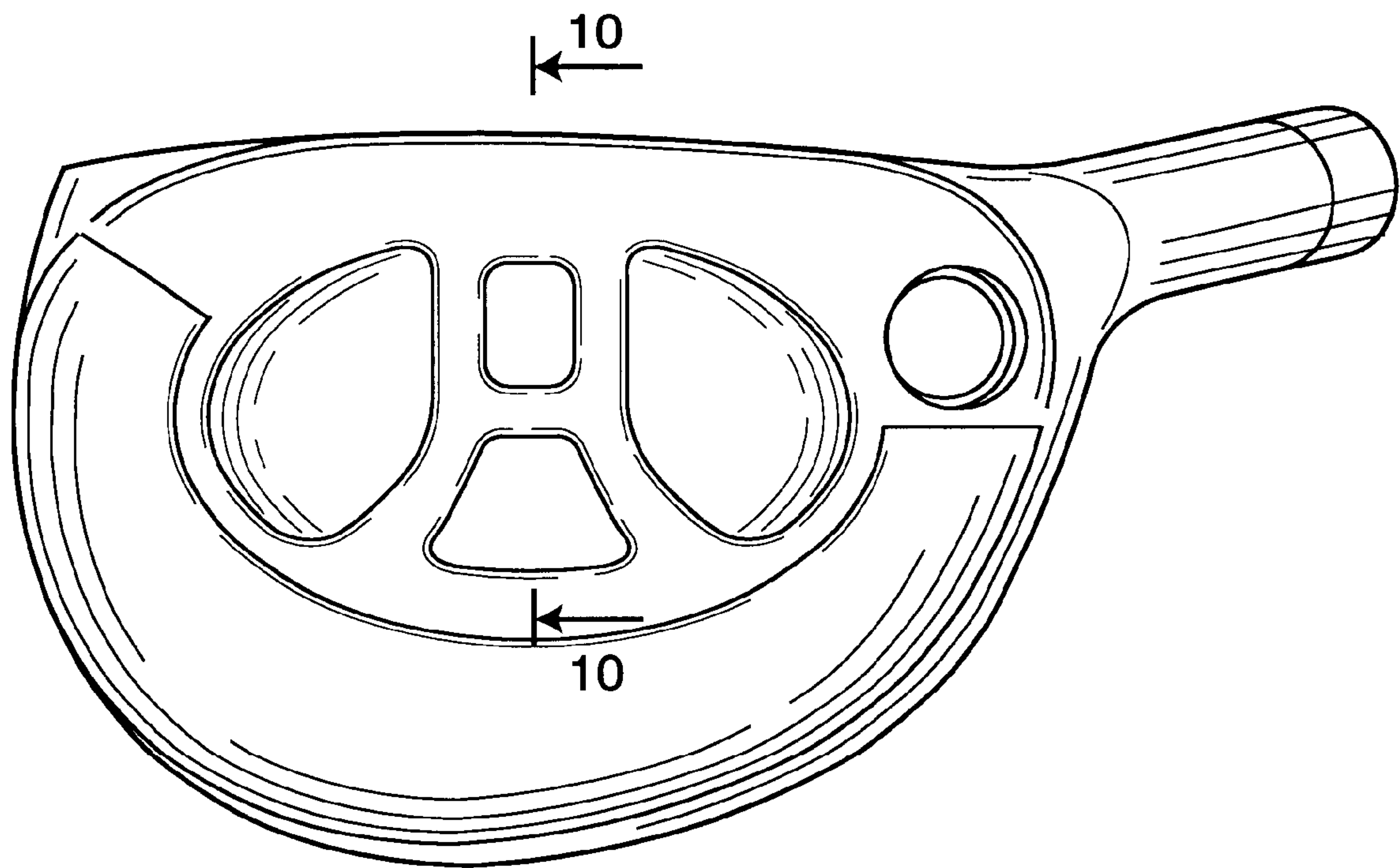

FIG. 9

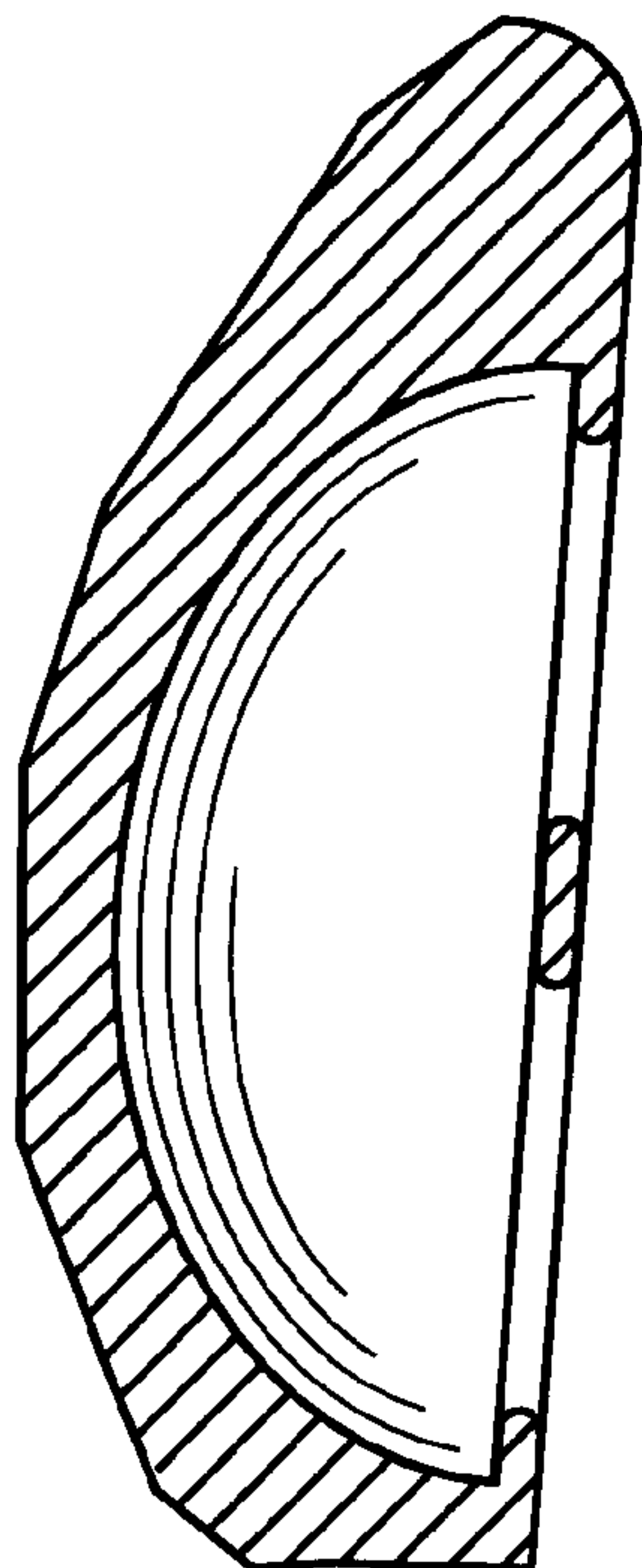

FIG. 10