



US00D521061S

(12) **United States Design Patent**  
**Katayama et al.**

(10) **Patent No.:** **US D521,061 S**

(45) **Date of Patent:** **\*\* May 16, 2006**

(54) **PRINTER**

(75) Inventors: **Shigeharu Katayama**, Kakamigahara (JP); **Toshiya Inada**, Nagoya (JP)

(73) Assignee: **Brother Industries, Ltd.**, Nagoya (JP)

(\*\*) Term: **14 Years**

(21) Appl. No.: **29/218,083**

(22) Filed: **Nov. 29, 2004**

(30) **Foreign Application Priority Data**

Jul. 15, 2004 (JP) ..... 2004-021457

(51) **LOC (8) Cl.** ..... **14-02**

(52) **U.S. Cl.** ..... **D18/55; D18/36; D14/422**

(58) **Field of Classification Search** ..... D18/36-39, D18/50, 54, 54.1, 55; D14/420-425, 462-470; 400/613, 613.1-613.4, 690.1-690.4, 691-694  
See application file for complete search history.

(56) **References Cited**

**U.S. PATENT DOCUMENTS**

- D329,870 S \* 9/1992 Hanasaki et al. .... D18/55
- D331,069 S \* 11/1992 Hanasaki et al. .... D18/55
- D332,258 S \* 1/1993 Urushihara et al. .... D14/464
- D434,067 S \* 11/2000 Chen ..... D18/36

- D434,434 S \* 11/2000 Short et al. .... D18/36
- D437,877 S \* 2/2001 Chen ..... D18/36
- D448,403 S \* 9/2001 Omuro et al. .... D14/425
- D449,851 S \* 10/2001 Katou et al. .... D18/36
- D456,834 S \* 5/2002 Fetherolf et al. .... D18/36
- D491,219 S \* 6/2004 Shimamura ..... D18/50
- D501,667 S \* 2/2005 Ishigami et al. .... D18/50
- D502,500 S \* 3/2005 Hoshiya et al. .... D18/50

\* cited by examiner

*Primary Examiner*—Cathy Anne MacCormac

(74) *Attorney, Agent, or Firm*—Oliff & Berridge, PLC

(57) **CLAIM**

The ornamental design for a printer, as shown and described.

**DESCRIPTION**

FIG. 1 is a perspective view of a printer;  
 FIG. 2 is a front view thereof;  
 FIG. 3 is a top view thereof;  
 FIG. 4 is a right-side view thereof;  
 FIG. 5 is a left-side view thereof;  
 FIG. 6 is a rear view thereof; and,  
 FIG. 7 is a bottom view thereof.  
 The broken line showing is for illustrative purposes only and forms no part of the claimed invention.

**1 Claim, 4 Drawing Sheets**

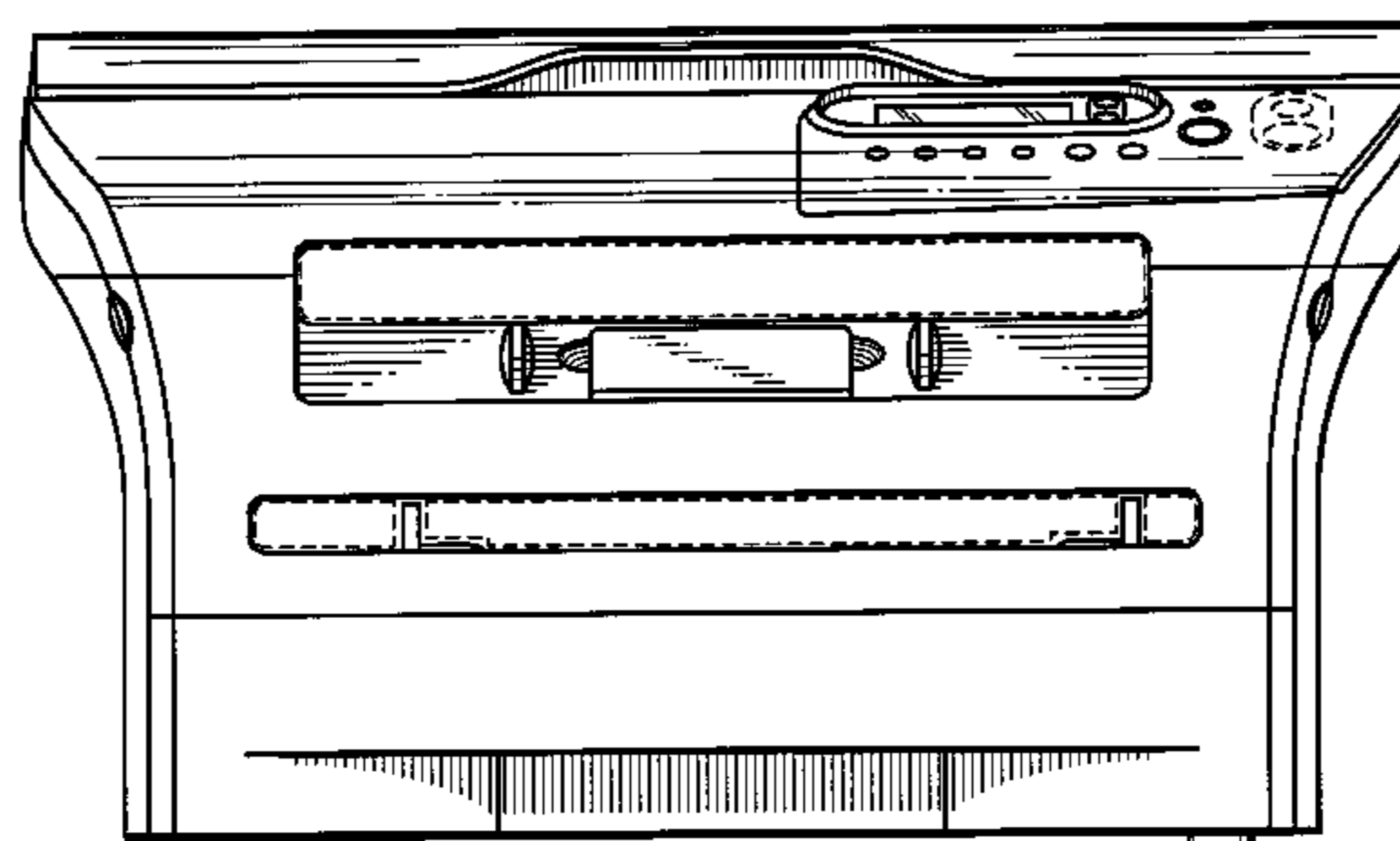
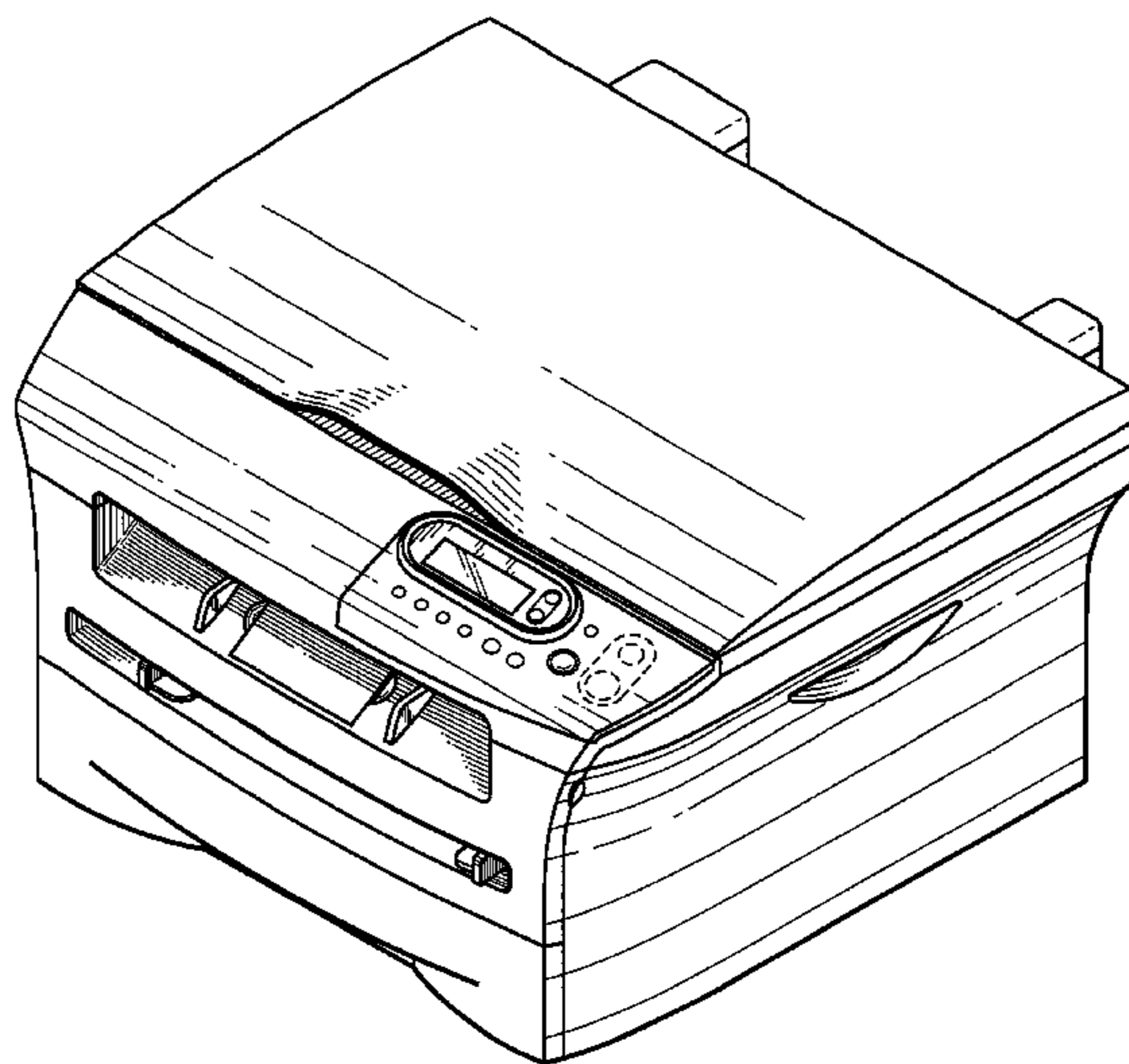



FIG. 1

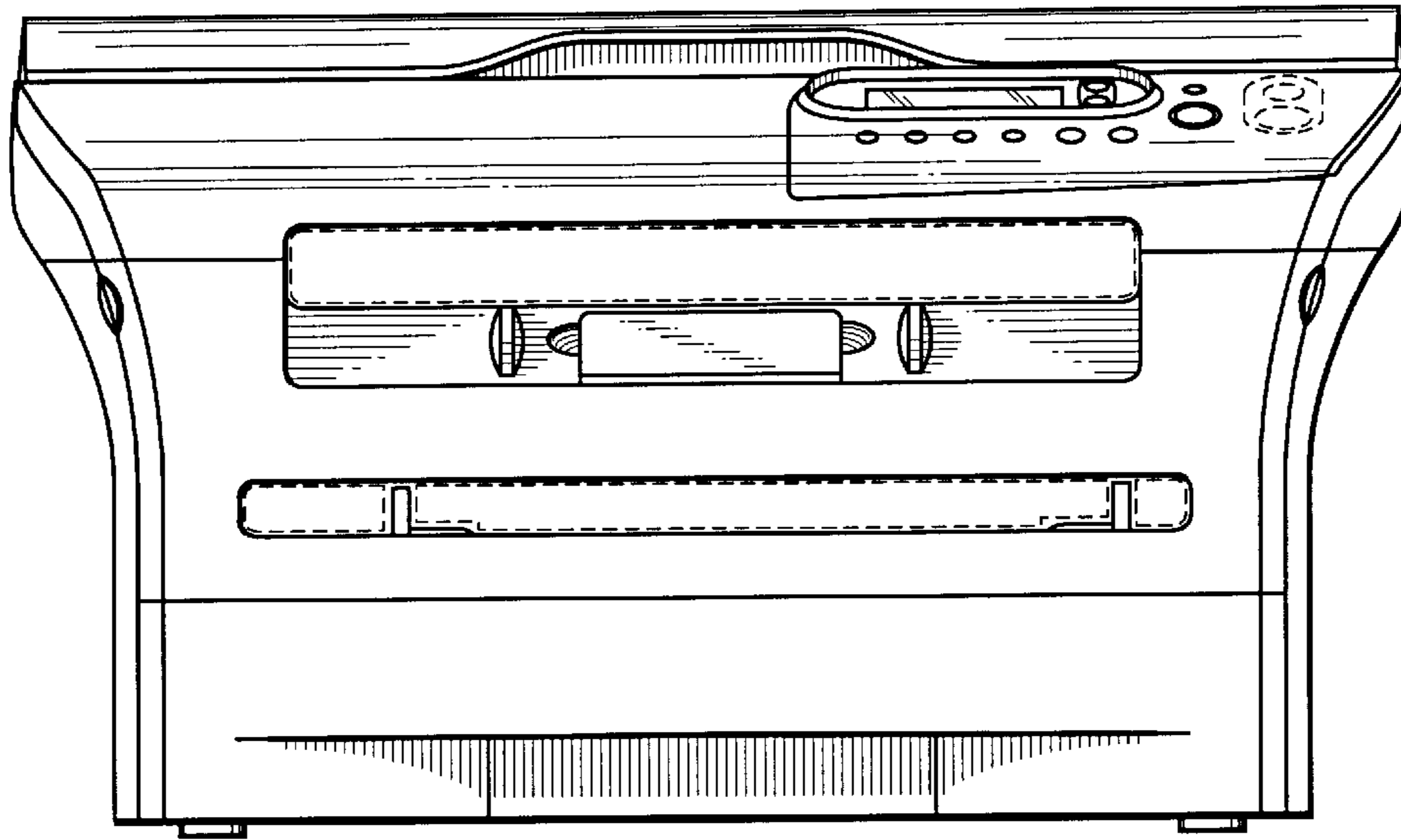

FIG. 2

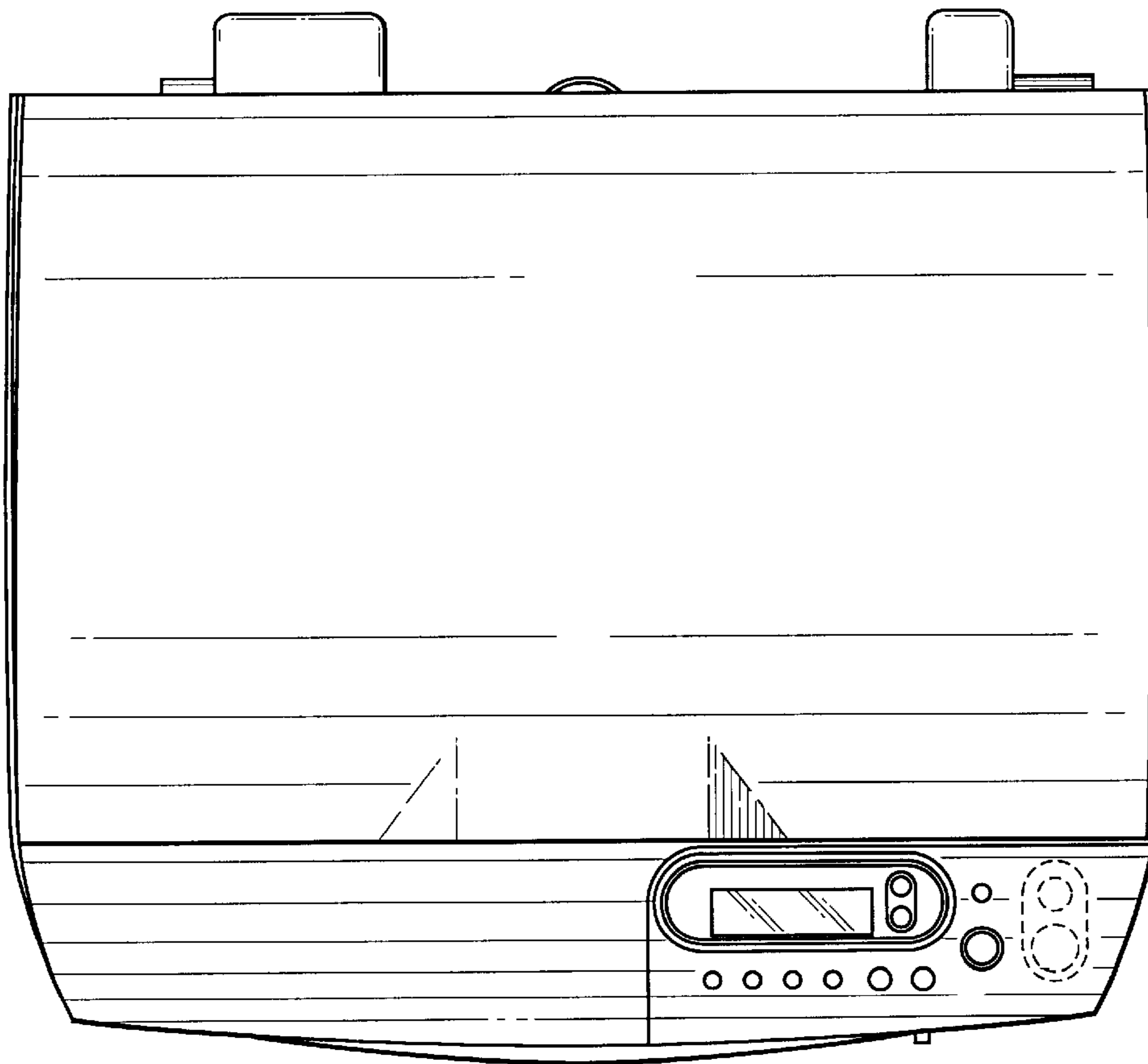

FIG. 3

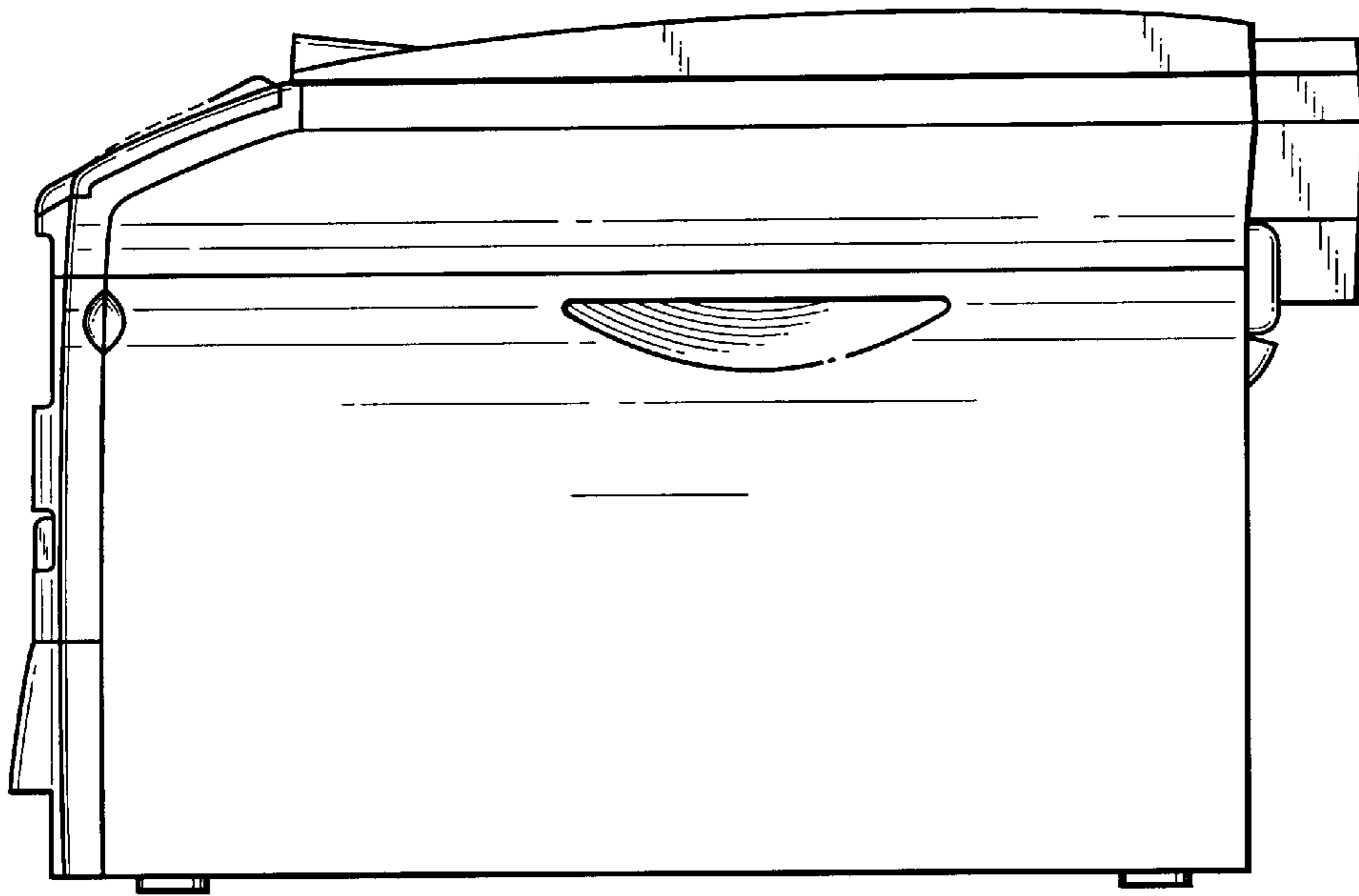

FIG. 4

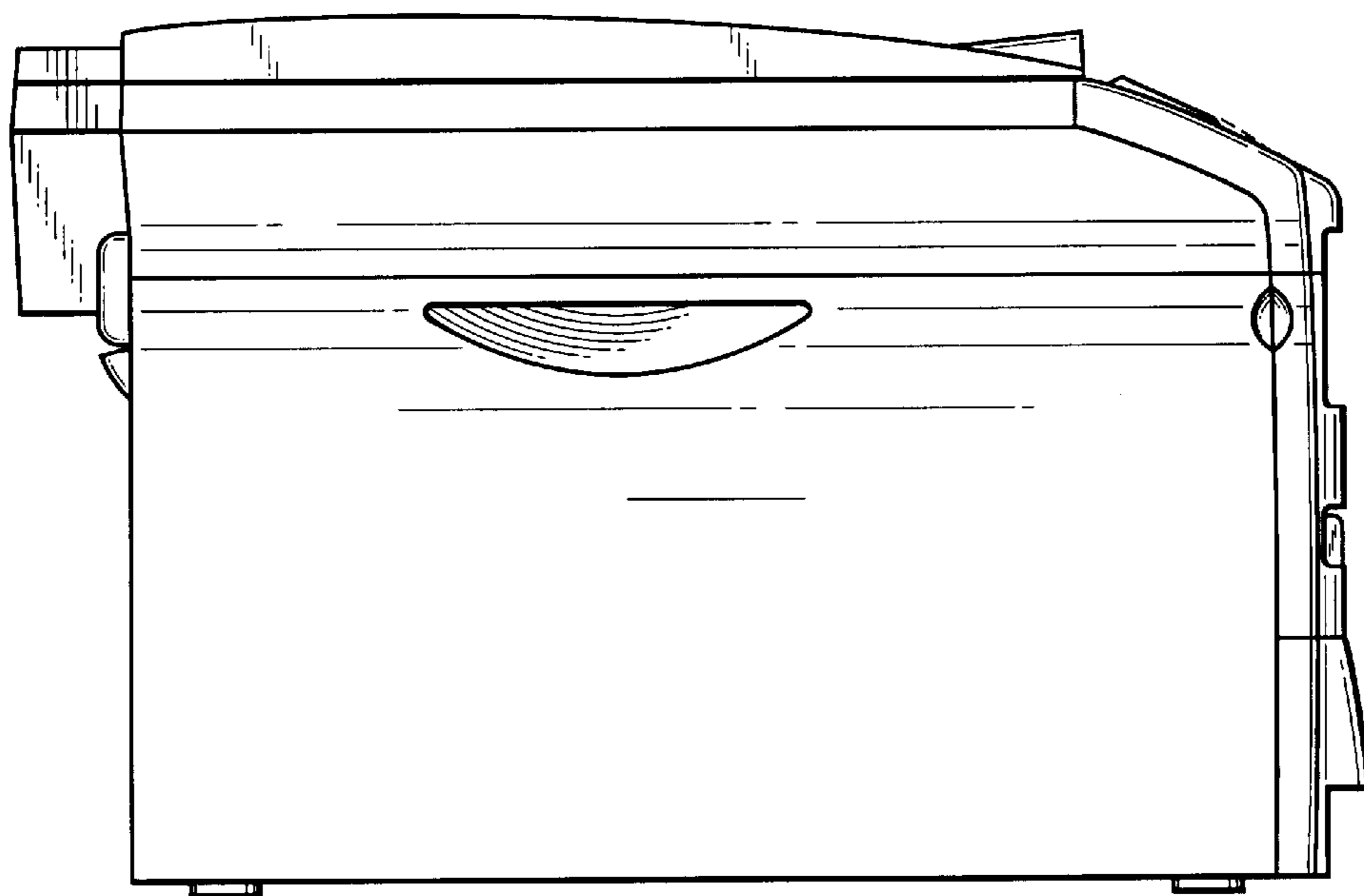

FIG. 5

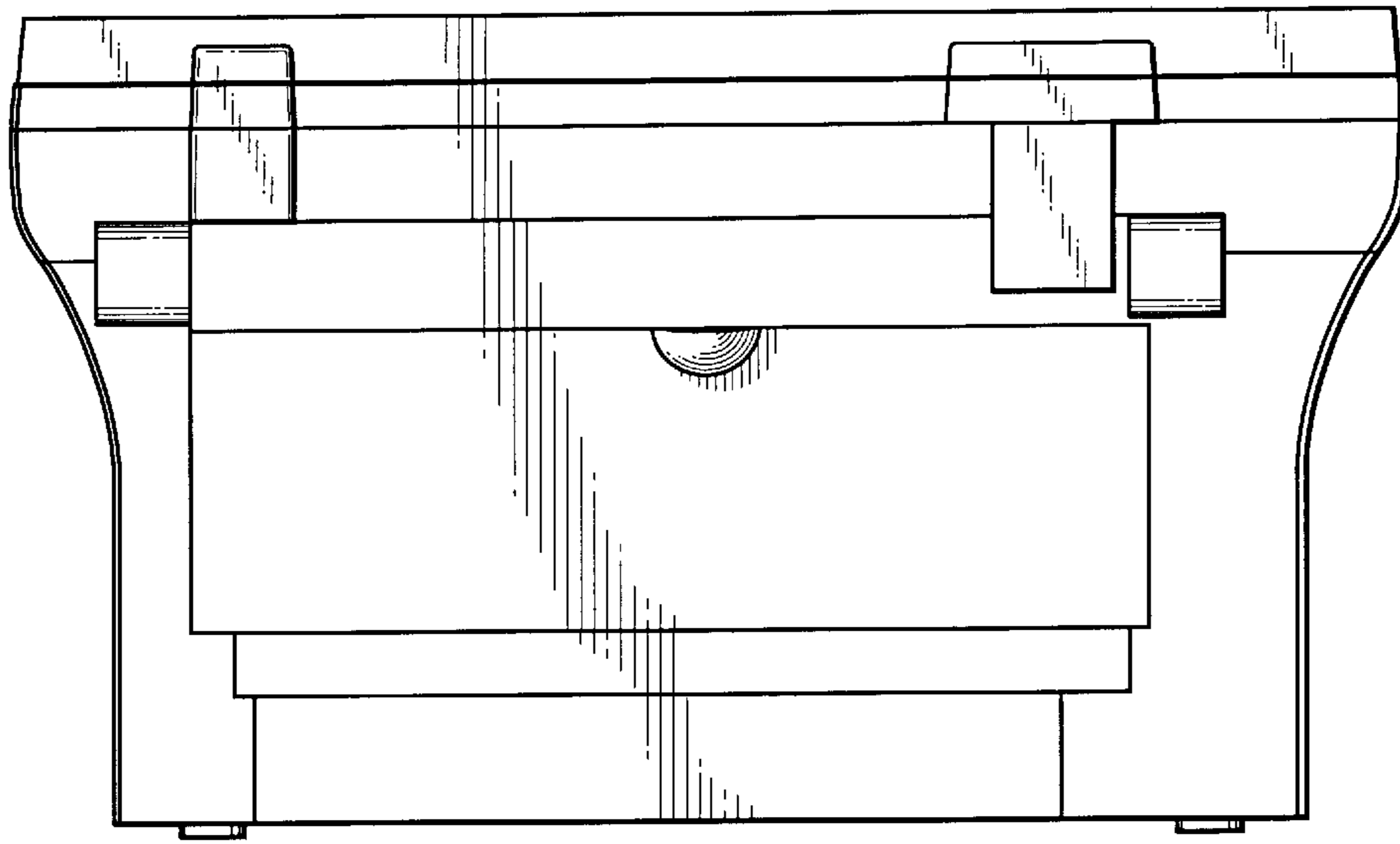

FIG. 6

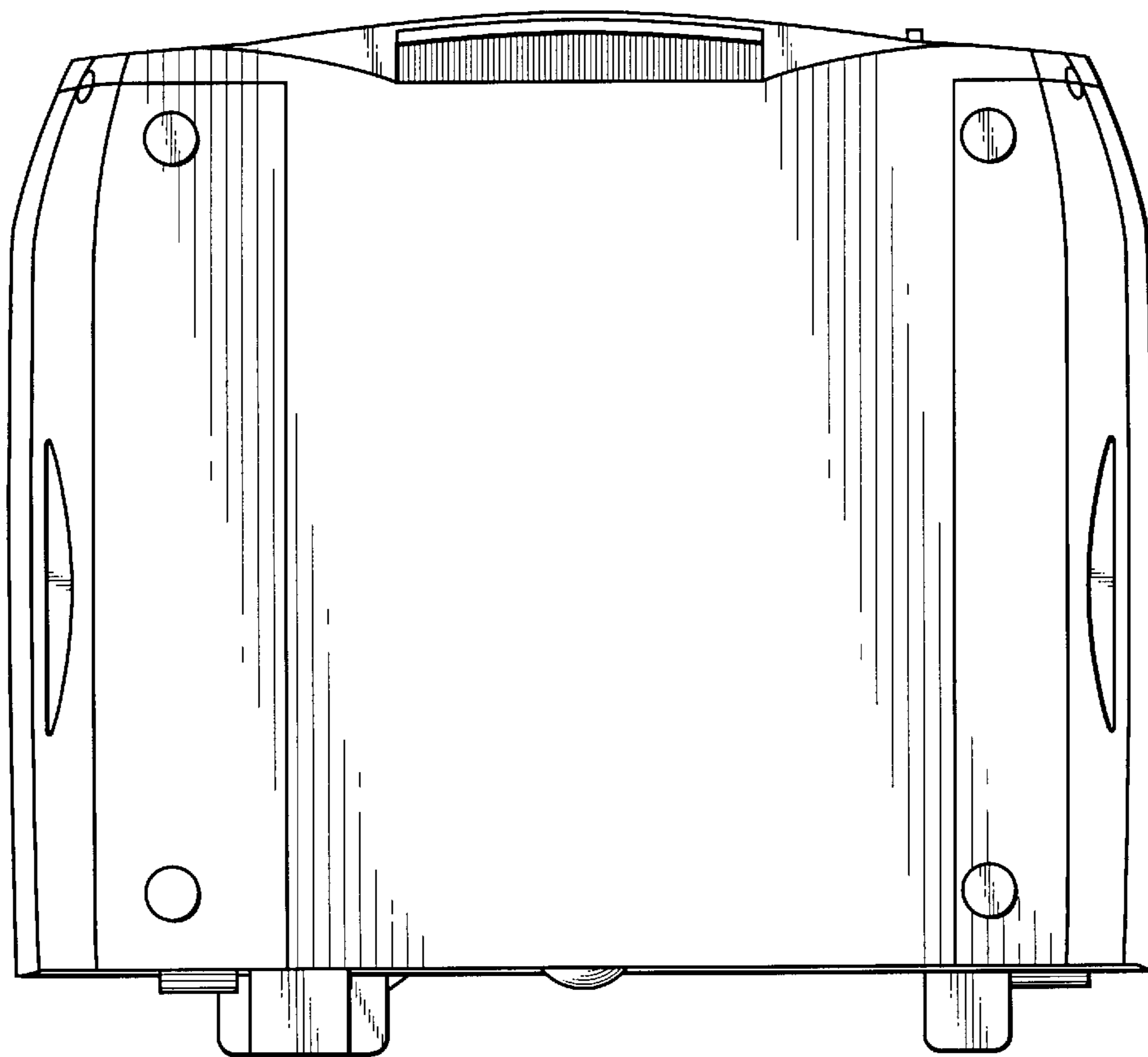

FIG. 7