



US00D521056S

(12) **United States Design Patent**
Horiguchi et al.

(10) **Patent No.:** **US D521,056 S**
(45) **Date of Patent:** **** May 16, 2006**

(54) **FULL COLOR MULTI-FUNCTION PRINTING MACHINE**

(75) Inventors: **Shigeru Horiguchi**, Kanagawa (JP);
Yoshihisa Minakawa, Tokyo (JP);
Tamaki Someya, Saitama (JP);
Masateru Kohno, Kanagawa (JP);
Kazuyoshi Yamada, Kanagawa (JP)

(73) Assignee: **Ricoh Company, Ltd.**, Tokyo (JP)

(**) Term: **14 Years**

(21) Appl. No.: **29/213,101**

(22) Filed: **Sep. 14, 2004**

(30) **Foreign Application Priority Data**

Mar. 20, 2004 (JP) 2004-011662

(51) **LOC (8) Cl.** **16-03**

(52) **U.S. Cl.** **D18/39**

(58) **Field of Classification Search** D18/36-39,
D18/45-55; 399/1-7, 16, 75, 81, 82, 107,
399/130, 151, 310, 361, 365; 355/97, 99;
358/1.1; 312/236; 222/DIG. 1
See application file for complete search history.

(56) **References Cited**

U.S. PATENT DOCUMENTS

D399,250 S * 10/1998 Kawai D18/55

D404,419 S * 1/1999 Kusanagi D18/39
D407,741 S * 4/1999 Kusanagi D18/55
D424,101 S * 5/2000 Takeuchi D18/53
D431,594 S * 10/2000 Watanabe et al. D18/41
6,404,994 B1 * 6/2002 Kawai et al. 399/6
D478,619 S * 8/2003 Agata et al. D18/55
6,725,001 B1 * 4/2004 Takahashi et al. 399/81
6,865,353 B1 * 3/2005 Fujita et al. 399/81

* cited by examiner

Primary Examiner—Caron D. Veynar

Assistant Examiner—Garth Rademaker

(74) *Attorney, Agent, or Firm*—Dickstein Shapiro Morin & Oshinsky LLP

(57) **CLAIM**

The ornamental design for a full color multi-function printing machine, as shown.

DESCRIPTION

FIG. 1 is a front elevation of a full color multi-function printing machine according to the present invention;
FIG. 2 is a rear elevation thereof;
FIG. 3 is a top plan view thereof;
FIG. 4 is a bottom plan view thereof;
FIG. 5 is a right side elevation thereof;
FIG. 6 is a left side elevation thereof; and,
FIG. 7 is a top, front and right side perspective view thereof.

1 Claim, 7 Drawing Sheets

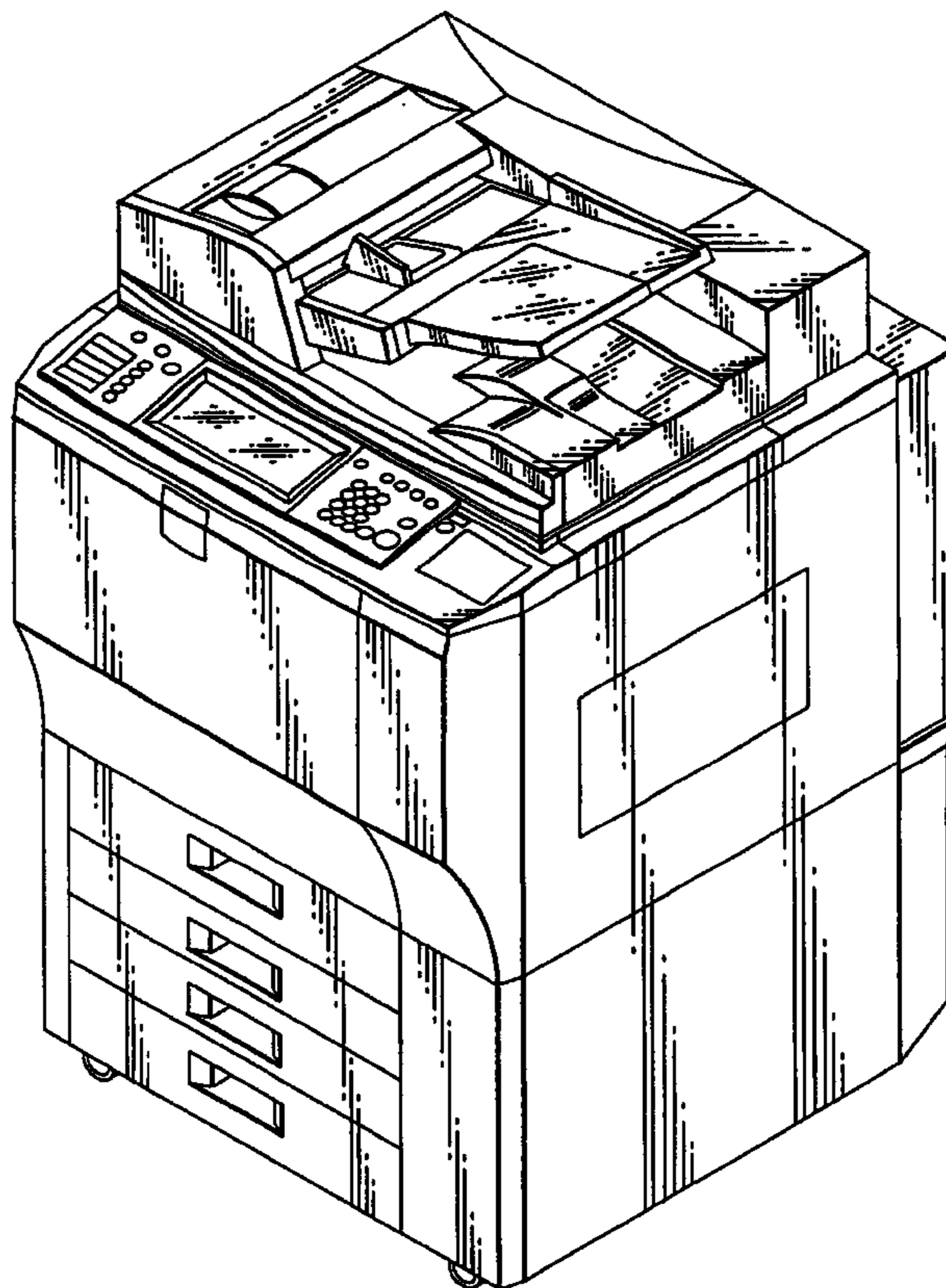

FIG. 1

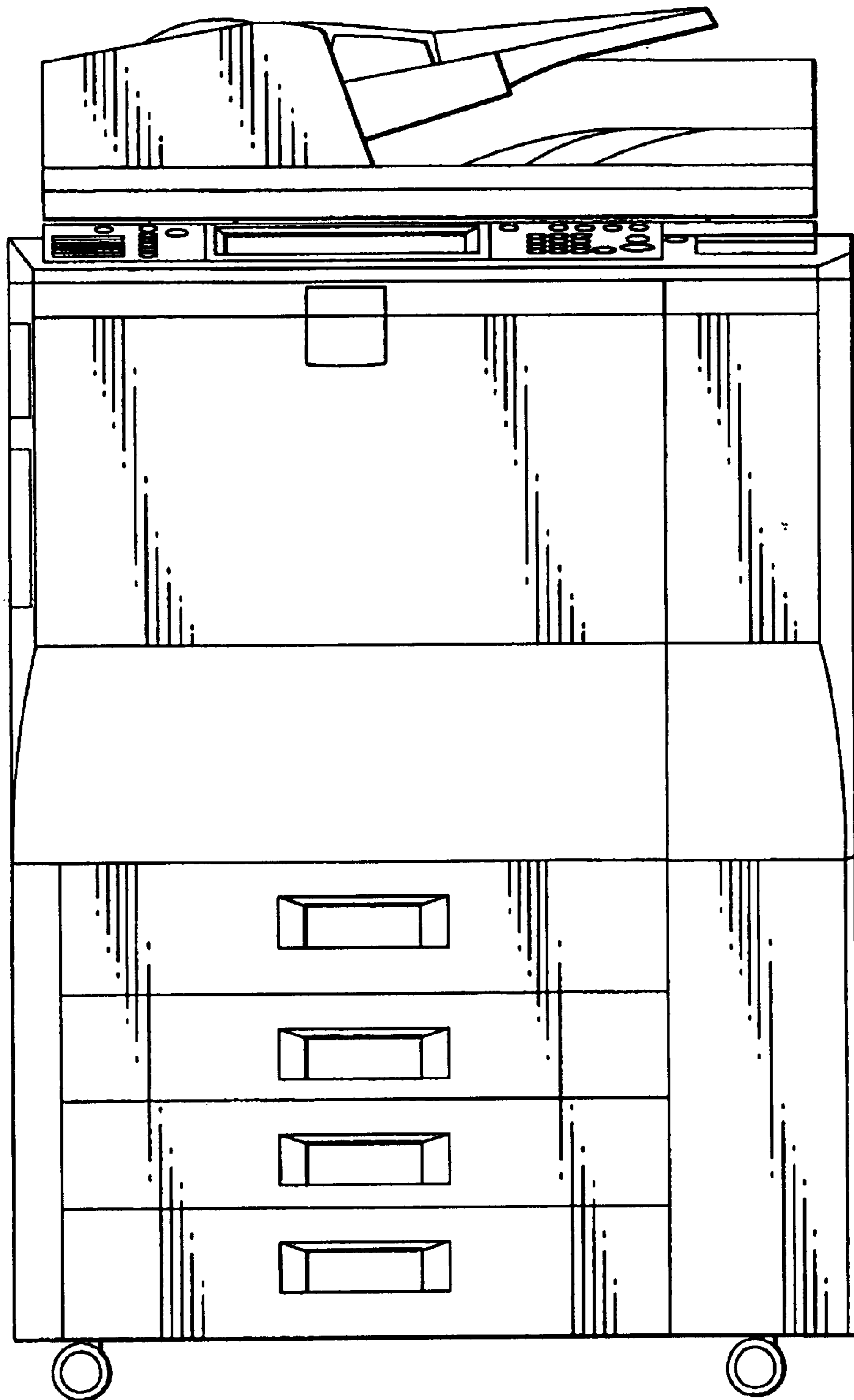

FIG. 2

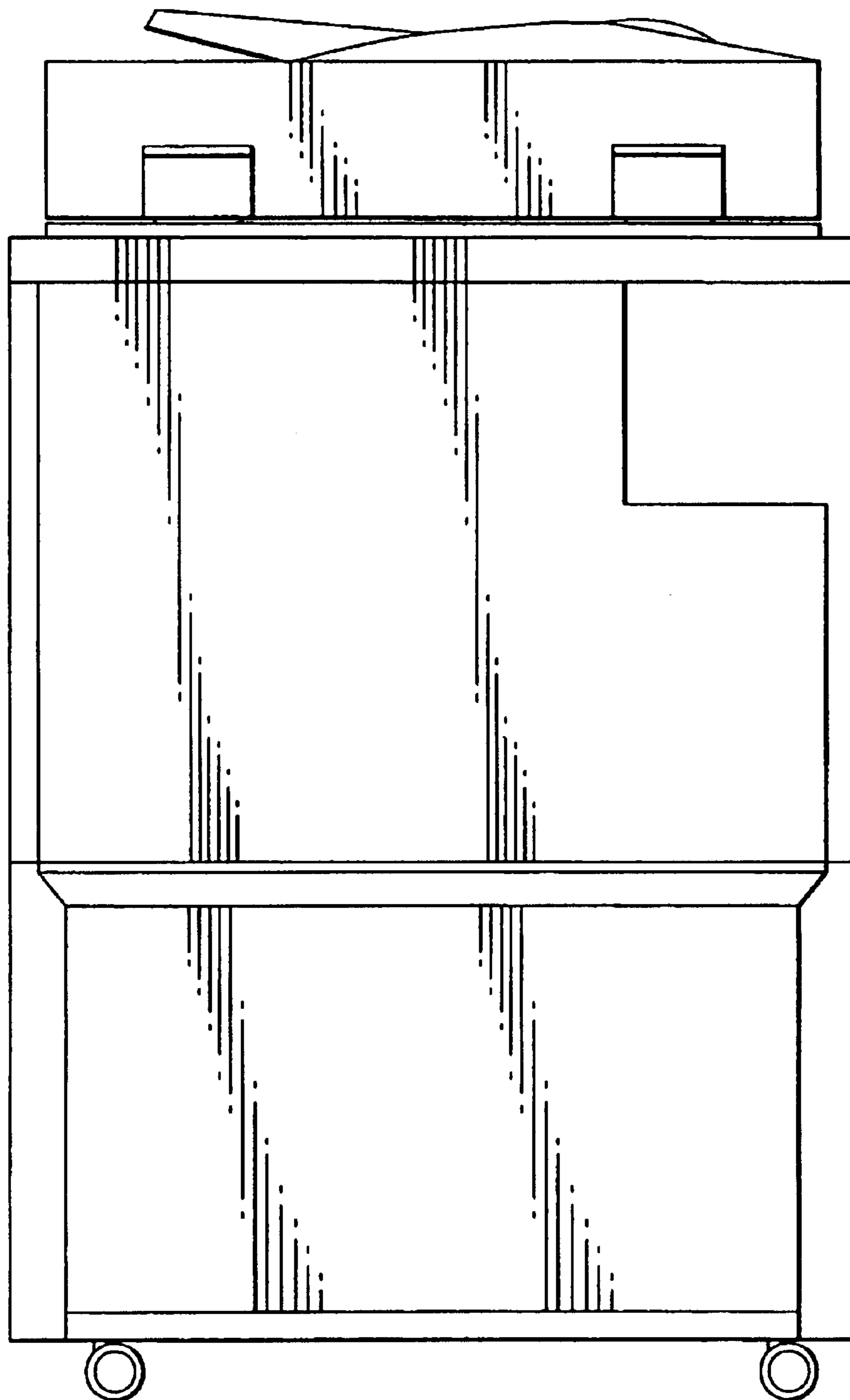

FIG. 3

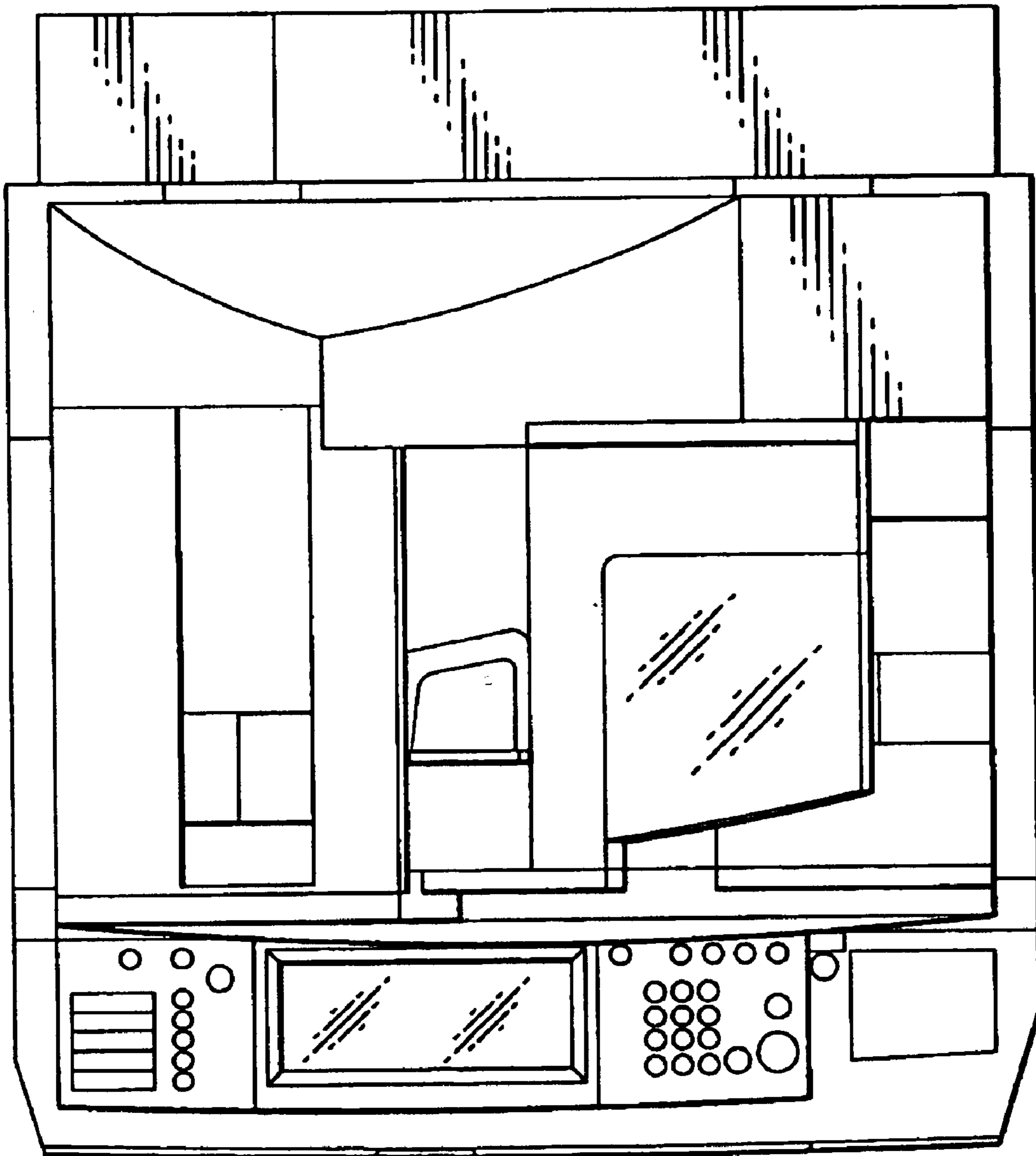

FIG. 4

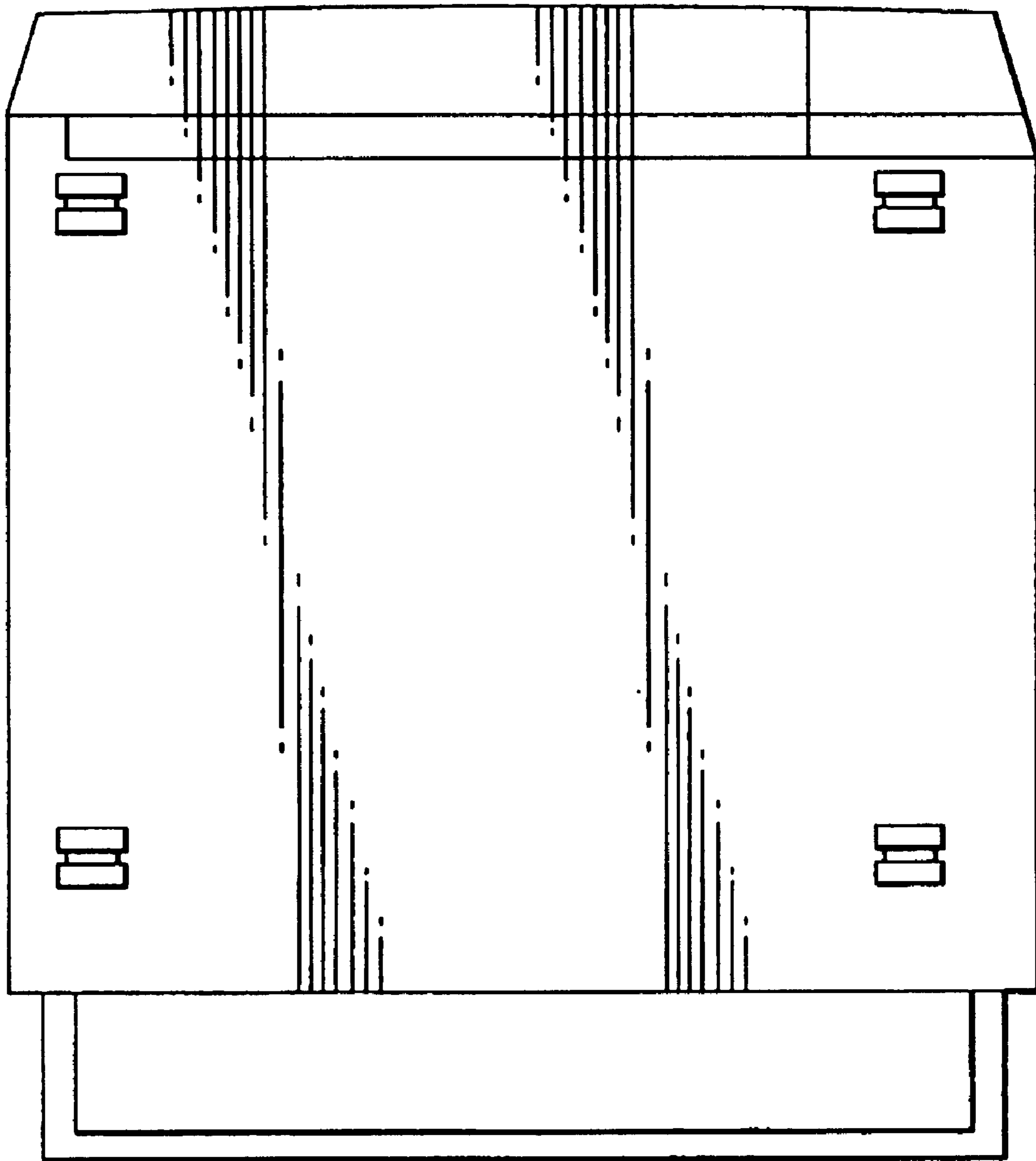

FIG. 5

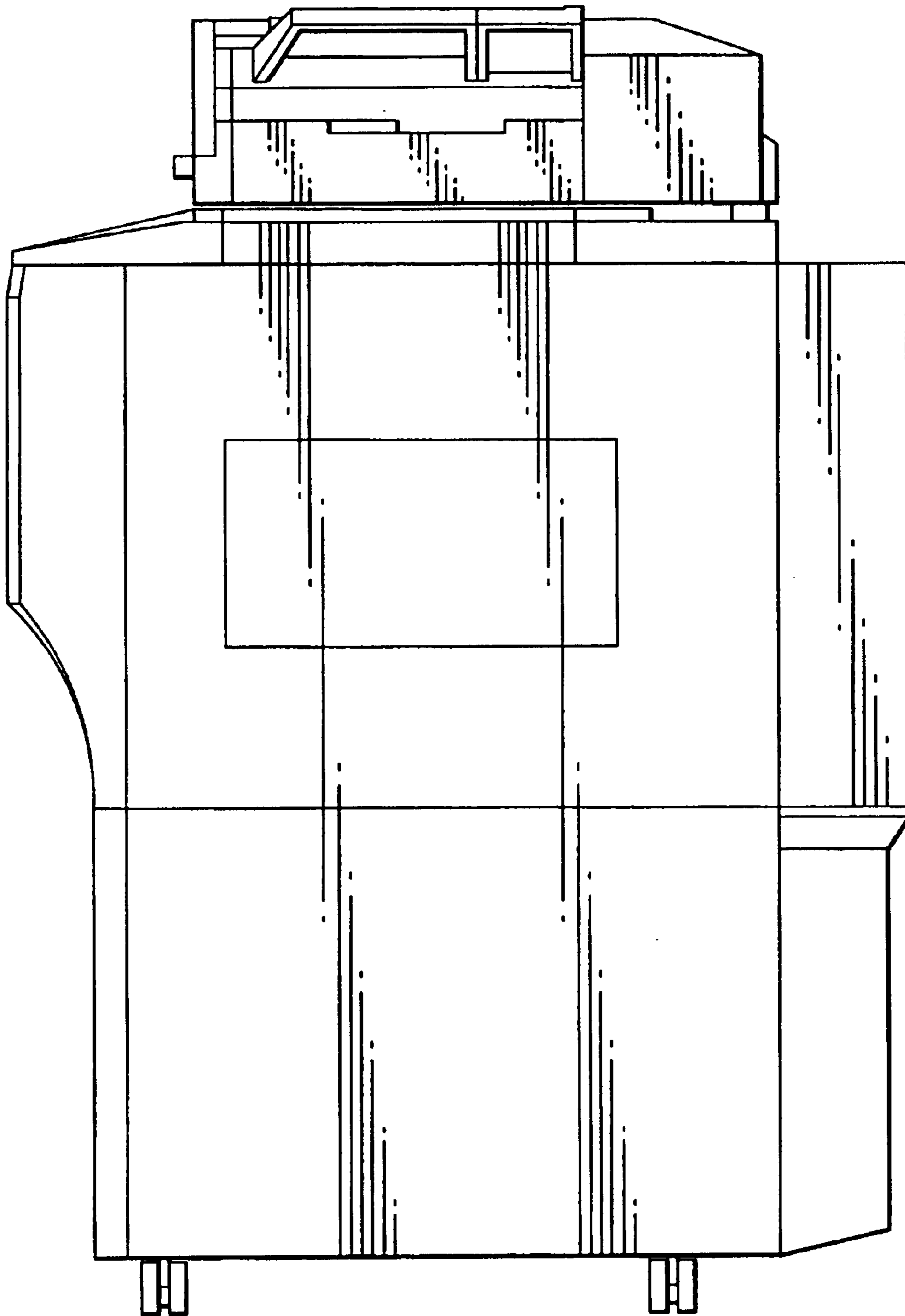

FIG. 6

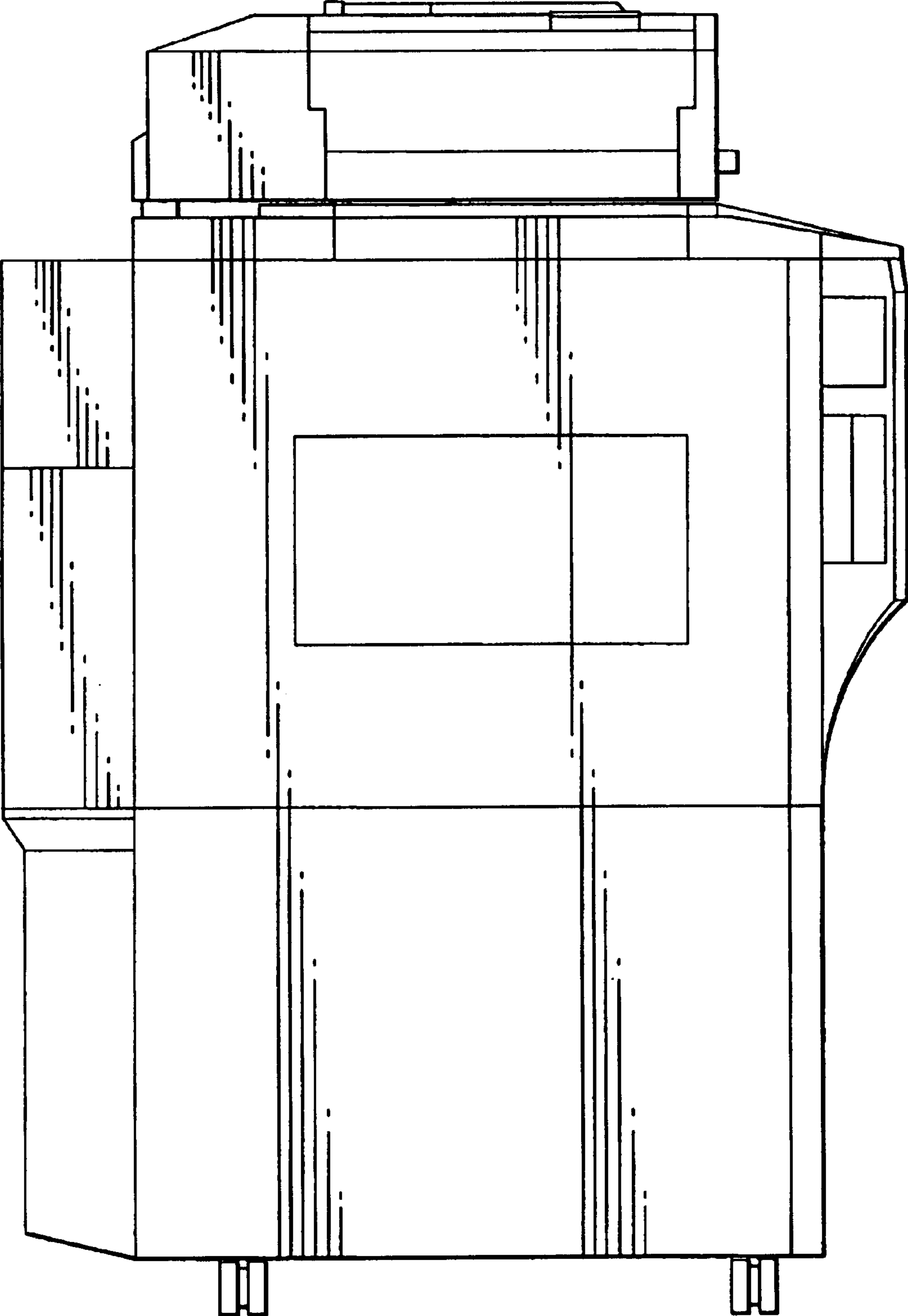

FIG. 7

