



US00D520982S

(12) **United States Design Patent**
Kim et al.

(10) **Patent No.:** **US D520,982 S**

(45) **Date of Patent:** **** May 16, 2006**

(54) **PORTABLE TELEPHONE**

(75) Inventors: **Jin-Soo Kim**, Seoul (KR); **Nam-Mi Kim**, Seoul (KR); **Chang-Hwan Hwang**, Seoul (KR)

(73) Assignee: **Samsung Electronics Co., Ltd.**, Kyunggi-do (KR)

(**) Term: **14 Years**

(21) Appl. No.: **29/226,443**

(22) Filed: **Mar. 29, 2005**

(51) **LOC (8) Cl.** **14-03**

(52) **U.S. Cl.** **D14/138**

(58) **Field of Classification Search** D14/137, D14/138, 147-148, 247-248, 144, 341-347; 379/433.01-433.13, 434; D21/517; 455/575.3, 455/566, 575.1; 345/169; 348/376, 14.02
See application file for complete search history.

(56) **References Cited**

U.S. PATENT DOCUMENTS

5,027,394 A	6/1991	Ono et al.
5,428,350 A	6/1995	Kurcbart et al.
5,436,954 A	7/1995	Nishiyama et al.
D407,716 S	4/1999	Park

(Continued)

FOREIGN PATENT DOCUMENTS

JP	D1154363	9/2002
JP	1159728	* 12/2002

OTHER PUBLICATIONS

U.S. Appl. No. 29/204,878, Applicant: Bum-Soo Park, et al., filed May 5, 2004 entitled Portable Telephone.
U.S. Appl. No. 29/204,882, Applicant: Jin-Soo Kim, et al., filed May 5, 2004 entitled Portable Telephone.
U.S. Appl. No. 29/204,874, Applicant: Jin-Soo Kim, et al., filed May 5, 2004 entitled Portable Telephone.
U.S. Appl. No. 29/204,875, Applicant: Jin-Soo Kim, et al., filed May 5, 2004 entitled Portable Telephone.

U.S. Appl. No. 29/204,883, Applicant: Jin-Soo Kim, et al., filed May 5, 2004 entitled Portable Telephone.

U.S. Appl. No. 29/205,555, Applicant: Chi-Young Ahn, et al., filed May 17, 2004 entitled Portable Telephone.

U.S. Appl. No. 29/205,559, Applicant: Chi-Young Ahn, et al., filed May 17, 2004 entitled Portable Telephone.

U.S. Appl. No. 29/205,546, Applicant: Chi-Young Ahn, et al., filed May 17, 2004 entitled Portable Telephone.

U.S. Appl. No. 29/214,253, Applicant: Hye-Jeong Lee, et al., filed Sep. 27, 2004 entitled Portable Telephone.

U.S. Appl. No. 29/216,563, Applicant: Jin-Soo Kim, et al., filed Nov. 4, 2004 entitled Portable Telephone.

U.S. Appl. No. 29/226,417, Applicant: Jin-Soo Kim, et al., filed Mar. 29, 2005 entitled Portable Telephone.

U.S. Appl. No. 29/226,418, Applicant: Ji-Hyun Moon, et al., filed Mar. 29, 2005 entitled Portable Telephone.

U.S. Appl. No. 29/226,419, Applicant: Min-Ah Koh, et al., filed Mar. 29, 2005 entitled Portable Telephone.

U.S. Appl. No. 29/226,420, Applicant: Min-Hyouk Lee, et al., filed Mar. 29, 2005 entitled Portable Telephone.

U.S. Appl. No. 29/226,442, Applicant: Min-Hyouk Lee, et al., filed Mar. 29, 2005 entitled Portable Telephone.

(Continued)

Primary Examiner—Jeffrey Asch

(74) *Attorney, Agent, or Firm*—Flynn, Thiel, Boutell & Tanis, P.C.

(57) **CLAIM**

The ornamental design for a portable telephone, as shown and described.

DESCRIPTION

FIG. 1. is a top front perspective view of a portable telephone showing our new design.

FIG. 2. is a front elevational view thereof.

FIG. 3. is a rear elevational view thereof.

FIG. 4. is a left side elevational view thereof.

FIG. 5. is a right side elevational view thereof.

FIG. 6. is a top plan view thereof; and,

FIG. 7. is a bottom plan view thereof.

1 Claim, 6 Drawing Sheets

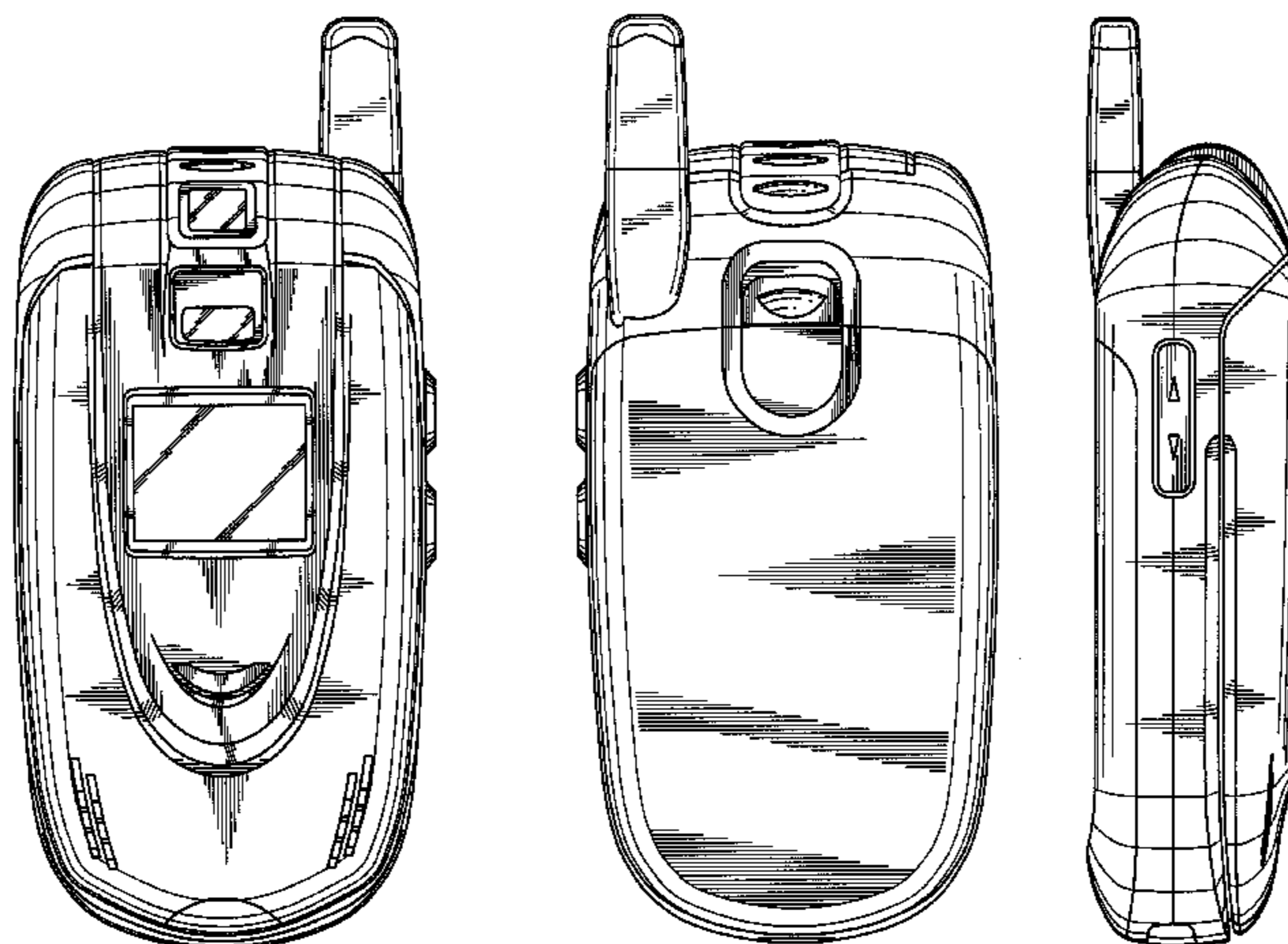

U.S. PATENT DOCUMENTS

D407,717 S 4/1999 Kim
 D407,718 S 4/1999 Lee
 D410,920 S 6/1999 Lee et al.
 D411,537 S 6/1999 Lee
 D414,765 S 10/1999 Park
 D415,151 S 10/1999 Kim
 D415,488 S 10/1999 Lee
 6,069,648 A 5/2000 Suso et al.
 D431,827 S 10/2000 Yim
 D440,955 S * 4/2001 Tanaka et al. D14/138
 D443,866 S * 6/2001 Arbisi et al. D14/138
 D446,201 S * 8/2001 Kim D14/138
 6,389,267 B1 5/2002 Imai
 6,396,924 B1 5/2002 Suso et al.
 D458,594 S 6/2002 Jang
 D463,386 S * 9/2002 Chun et al. D14/138
 D465,467 S * 11/2002 Nagai et al. D14/138
 D469,070 S * 1/2003 Lee D14/138
 D474,168 S * 5/2003 Wang et al. D14/138
 D475,986 S * 6/2003 Ng et al. D14/138
 D477,293 S 7/2003 Hwang
 D477,295 S * 7/2003 Chung D14/138
 D477,581 S * 7/2003 Iijima et al. D14/138
 D481,697 S * 11/2003 Rausch et al. D14/138
 D484,862 S 1/2004 Yang
 D484,863 S 1/2004 Chan
 D485,249 S 1/2004 Liao et al.
 D485,817 S * 1/2004 Liao et al. D14/138
 D485,818 S * 1/2004 Yabe et al. D14/138
 D486,811 S 2/2004 Lheem
 D487,071 S * 2/2004 Hotta et al. D14/138
 D487,443 S 3/2004 Yoon
 D487,444 S 3/2004 Yoon
 D488,453 S 4/2004 Chang et al.
 D489,698 S 5/2004 Kim et al.
 D489,699 S 5/2004 Hwang et al.
 D490,389 S 5/2004 Yang
 D490,792 S * 6/2004 Lee D14/138
 D491,547 S * 6/2004 Cho D14/138
 D491,906 S 6/2004 Okamatsu
 D491,907 S 6/2004 Ogawa
 D493,439 S * 7/2004 Hong et al. D14/138
 D493,440 S 7/2004 Chou et al.
 D495,672 S 9/2004 Jeon et al.
 D495,674 S 9/2004 Yoo et al.
 D496,020 S 9/2004 Lee
 D496,021 S 9/2004 Jang
 D498,220 S * 11/2004 Park D14/138
 D500,016 S * 12/2004 Kim D14/138
 D500,993 S 1/2005 Hwang
 D501,458 S 2/2005 Kim et al.
 D501,658 S 2/2005 Park et al.
 D501,837 S 2/2005 Kim et al.
 D501,838 S 2/2005 Kim et al.
 D502,161 S 2/2005 Kim et al.
 D502,458 S * 3/2005 Chung et al. D14/138
 D503,164 S 3/2005 Park et al.
 D503,695 S * 4/2005 Kota et al. D14/138
 D504,406 S 4/2005 Cho et al.

D505,125 S * 5/2005 Ahn et al. D14/138
 D506,454 S 6/2005 Kim et al.
 D506,738 S 6/2005 Kim et al.
 D506,739 S * 6/2005 Shin et al. D14/138
 D507,252 S 7/2005 Kim et al.
 D507,787 S * 7/2005 Ahn et al. D14/138
 D508,030 S * 8/2005 Jeoung et al. D14/138
 D508,032 S * 8/2005 Kim et al. D14/138
 D508,036 S * 8/2005 Wada D14/138
 D510,733 S * 10/2005 Lee et al. D14/138
 2001/0036845 A1 11/2001 Park
 2002/0187818 A1 12/2002 Kang
 2003/0109232 A1 6/2003 Park et al.
 2004/0009790 A1 1/2004 Im
 2004/0023684 A1 2/2004 Sato et al.
 2004/0097258 A1 * 5/2004 Lee et al. 455/550.1
 2004/0097262 A1 5/2004 Lee
 2004/0132513 A1 * 7/2004 Taneda et al. 455/575.3
 2004/0142718 A1 7/2004 Kim
 2004/0142734 A1 7/2004 Kim

OTHER PUBLICATIONS

U.S. Appl. No. 29/226,470, Applicant: Nam-Su Kim, et al., filed Mar. 29, 2005 entitled Portable Telephone.
 U.S. Appl. No. 29/226,474, Applicant: Nam-Su Kim, et al., filed Mar. 29, 2005 entitled Portable Telephone.
 U.S. Appl. No. 29/226,460, Applicant: Nam-Su Kim, et al., filed Mar. 29, 2005 entitled Portable Telephone.
 U.S. Appl. No. 29/226,461, Applicant: Joon-Ki Yun, et al., filed Mar. 29, 2005 entitled Portable Telephone.
 U.S. Appl. No. 29/226,462, Applicant: Yu-Guen Kim, et al., filed Mar. 29, 2005 entitled Portable Telephone.
 U.S. Appl. No. 29/226,463, Applicant: Jin-Soo Kim, et al., filed Mar. 29, 2005 entitled Portable Telephone.
 U.S. Appl. No. 29/226,465, Applicant: Ki-Eon Lee, et al., filed Mar. 29, 2005 entitled Portable Telephone.
 U.S. Appl. No. 29/226,464, Applicant: Joon-Ki Yun, et al., filed Mar. 29, 2005 entitled Portable Telephone.
 U.S. Appl. No. 29/226,454, Applicant: Woo-Seung Han, et al., filed Mar. 29, 2005 entitled Portable Telephone.
 U.S. Appl. No. 29/226,455, Applicant: Woo-Seung Han, et al., filed Mar. 29, 2005 entitled Portable Telephone.
 U.S. Appl. No. 29/226,982, Applicant: Yu-Guen Kim, et al., filed Apr. 5, 2005 entitled Portable Telephone.
 U.S. Appl. No. 29/226,990, Applicant: Yu-Guen Kim, et al., filed Apr. 5, 2005 entitled Portable Telephone.
 U.S. Appl. No. 29/227,339, Applicant: Joon-Suh Kim, et al., filed Apr. 7, 2005 entitled Portable Telephone.
 U.S. Appl. No. 29/227,338, Applicant: Joon-Suh Kim, et al., filed Apr. 7, 2005 entitled Portable Telephone.
 U.S. Appl. No. 29/227,258, Applicant: Min-Ah Koh, et al., filed Apr. 8, 2005 entitled Portable Telephone.
 U.S. Appl. No. 29/219,068, Applicant: Dae-Yoeb Park, et al., filed Dec. 10, 2004 entitled Portable Telephone.
 U.S. Appl. No. 29/224,584, Applicant: Ha-Youl Jung, et al., filed Mar. 3, 2005 entitled Portable Telephone.

* cited by examiner

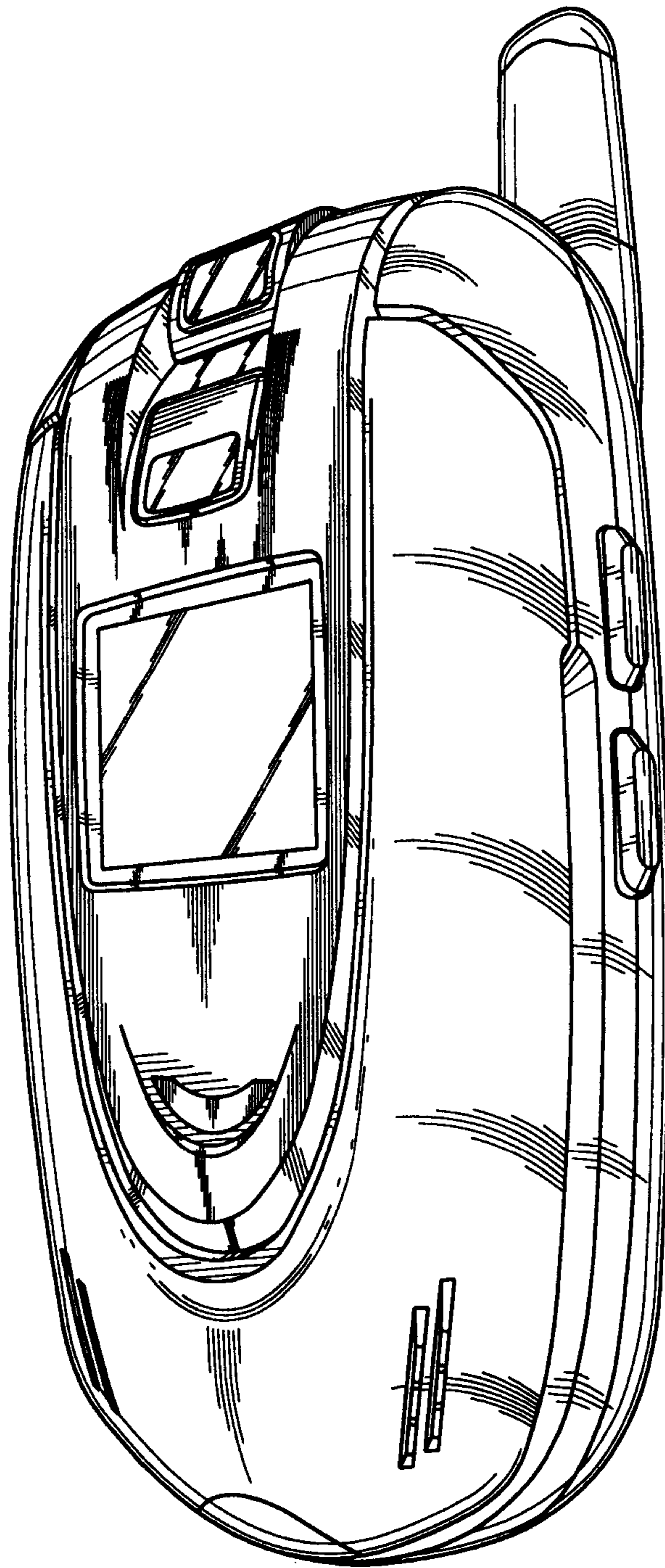

FIG. 1

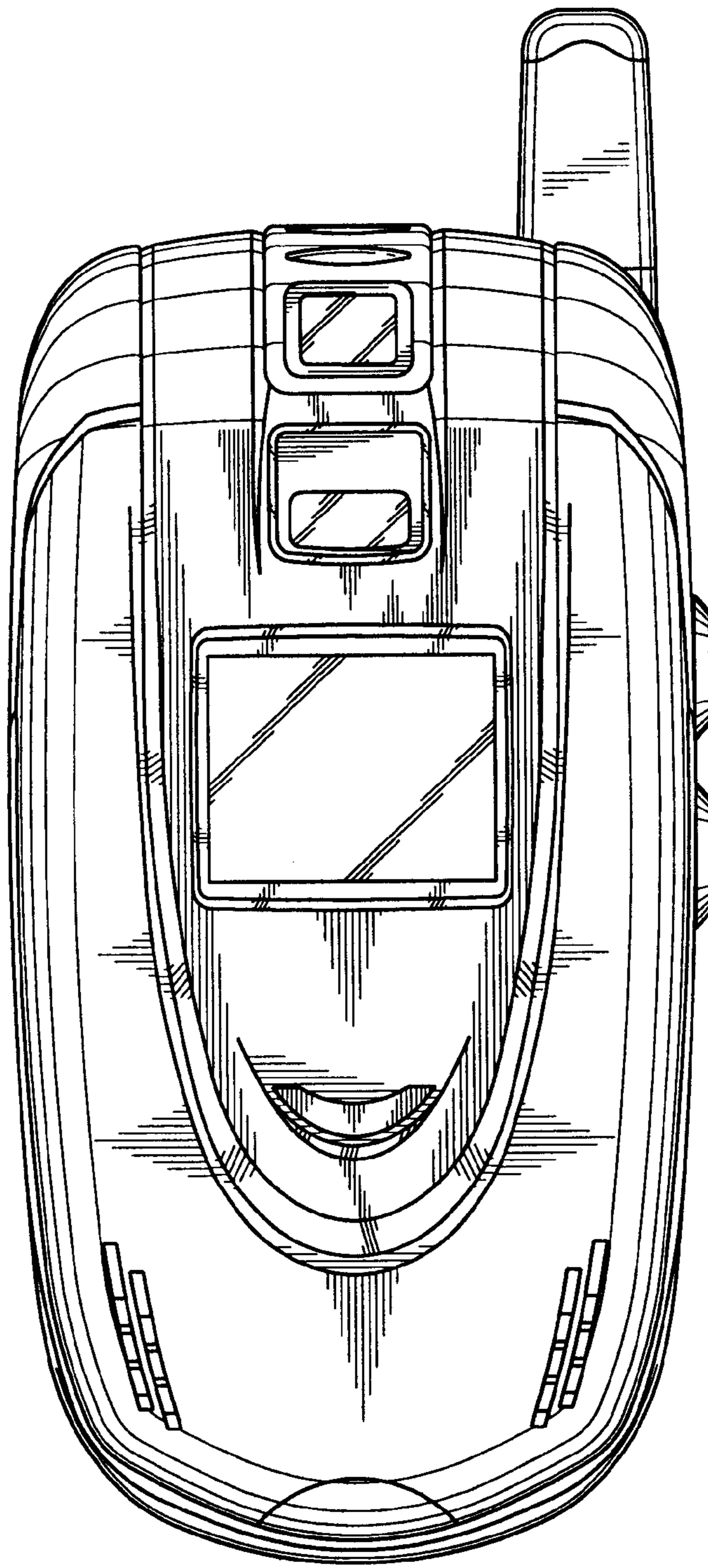

FIG. 2

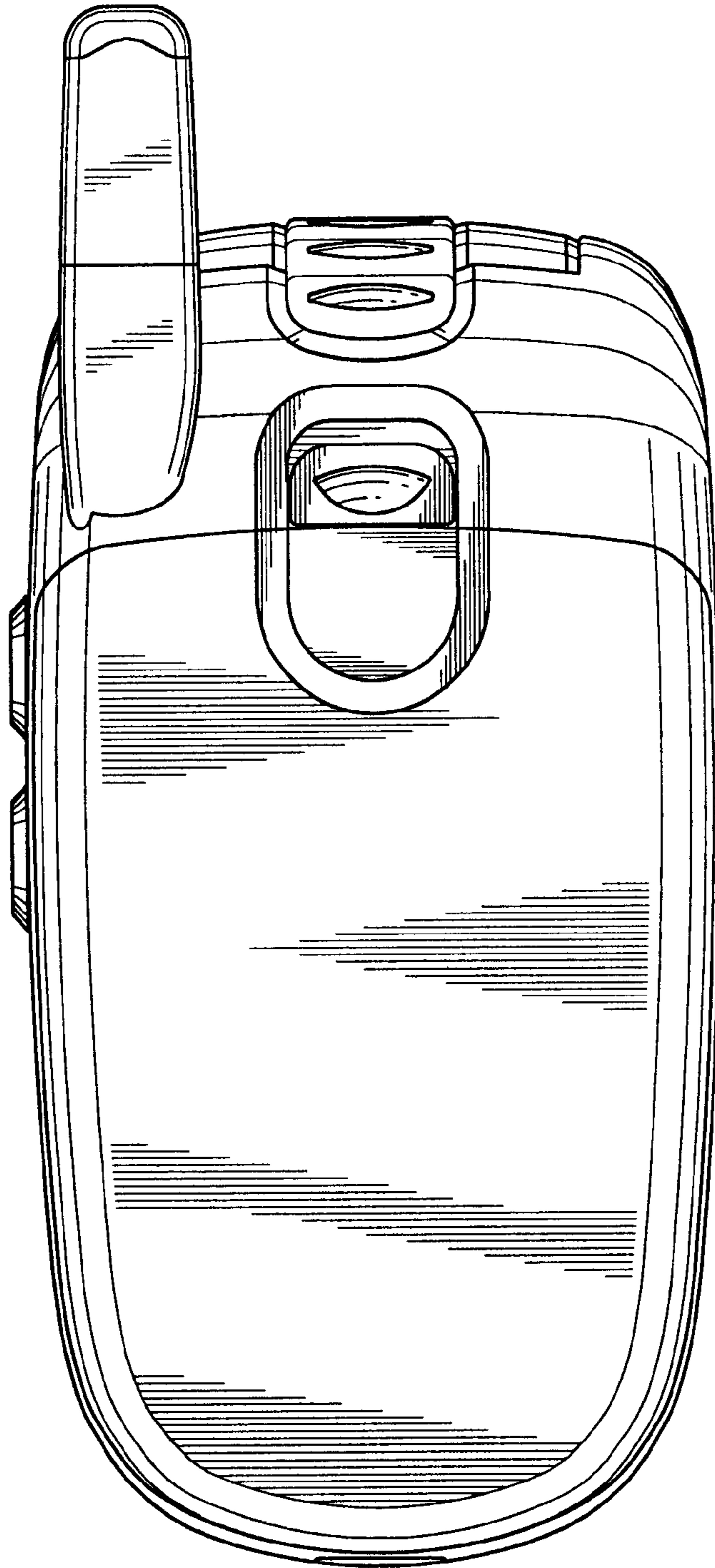

FIG. 3

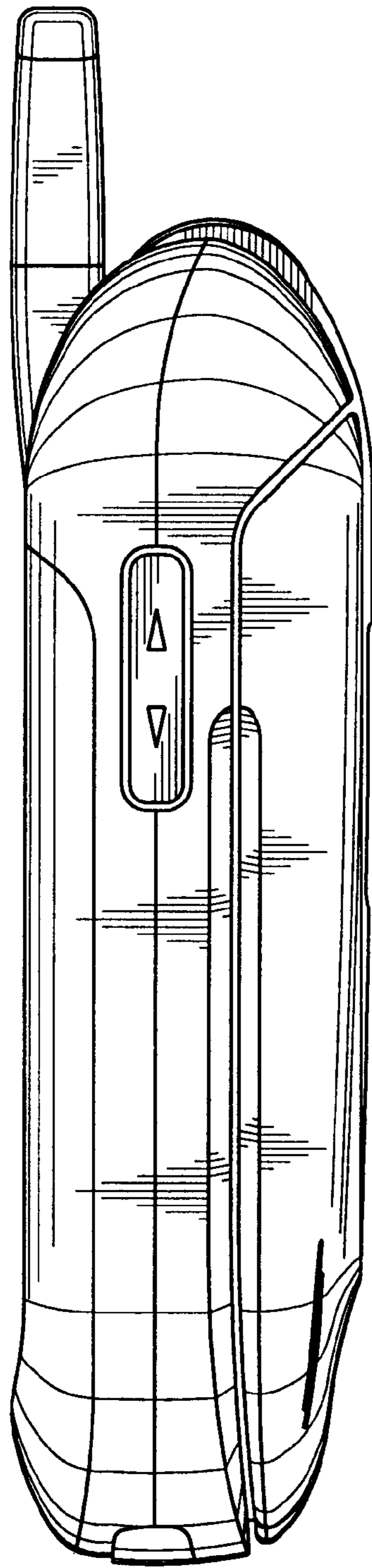

FIG. 4

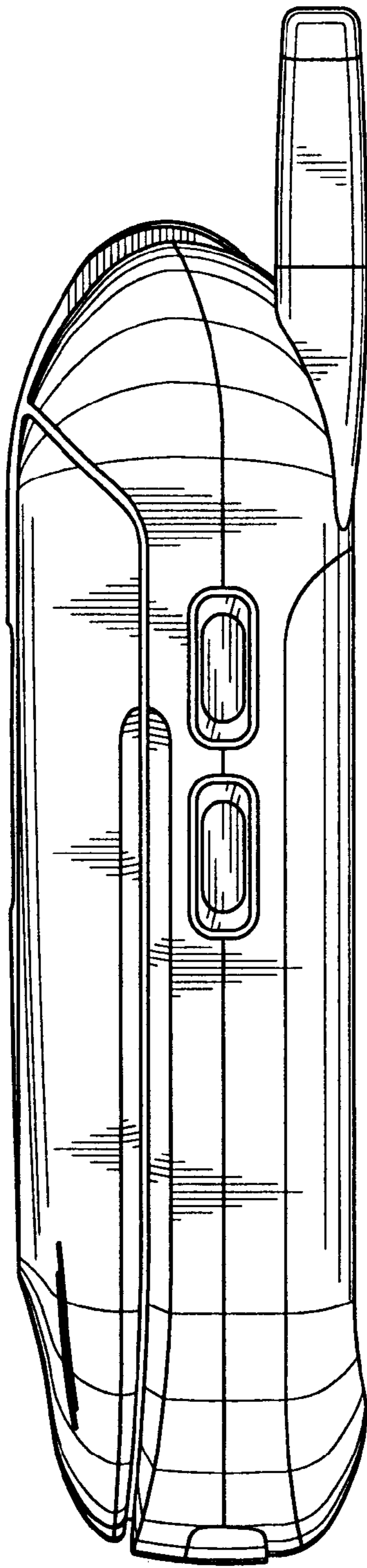

FIG. 5

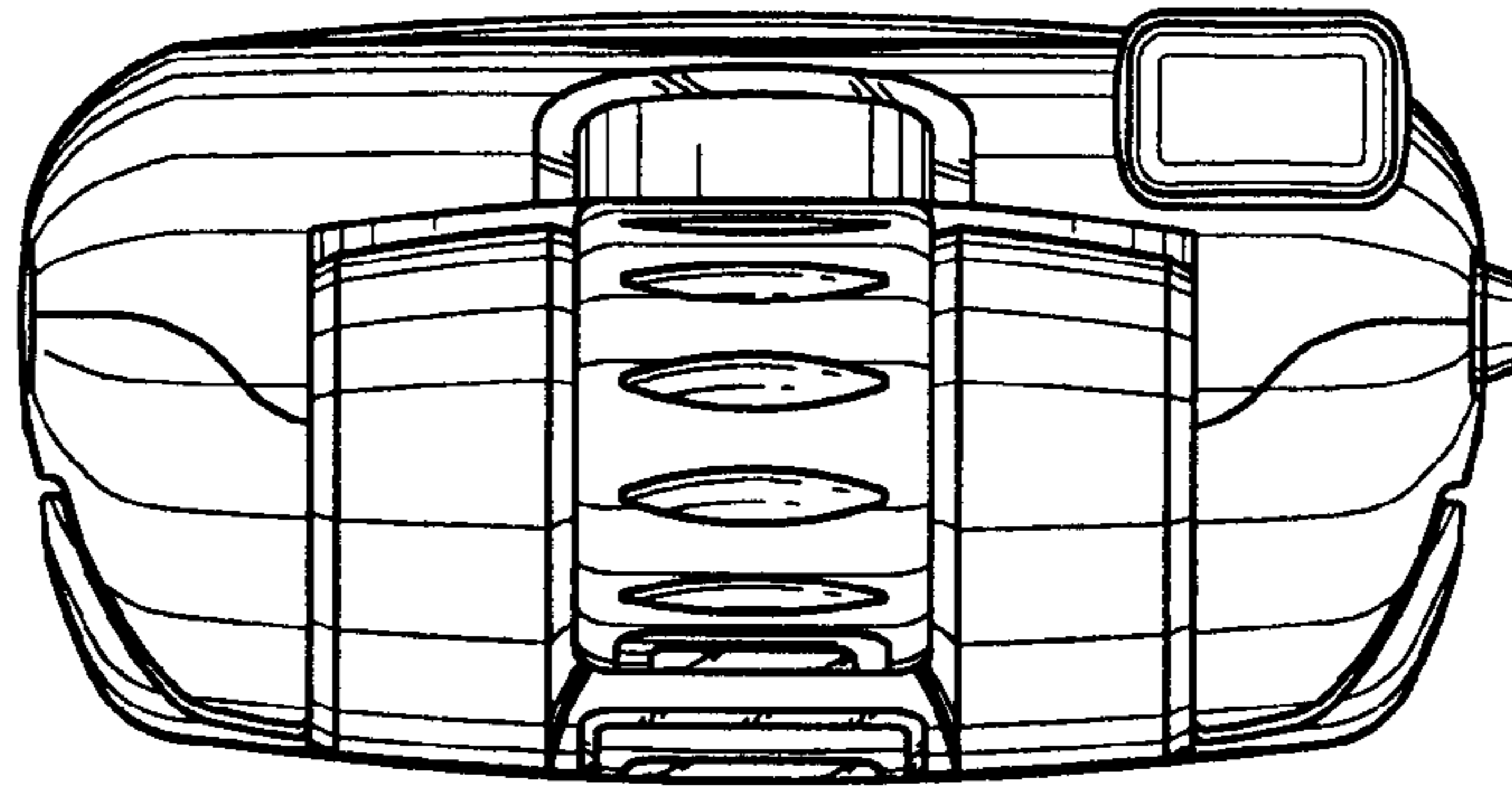

FIG. 6

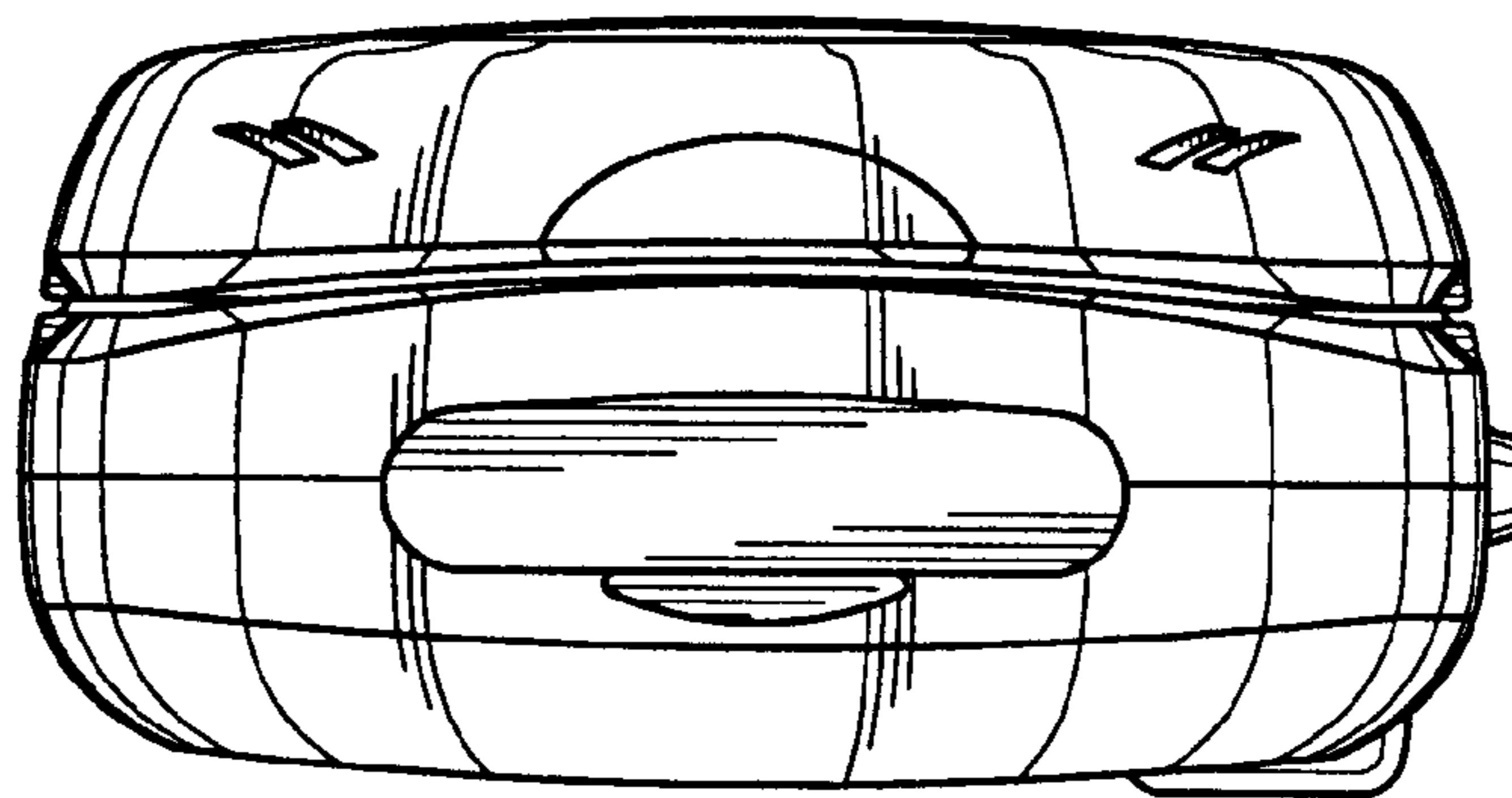

FIG. 7