

US00D520975S

(12) **United States Design Patent**
Kim et al.

(10) **Patent No.:** **US D520,975 S**
(45) **Date of Patent:** **** May 16, 2006**

(54) **BLU-RAY PLAYER**

(75) Inventors: **Han Kim**, Seoul (KR); **Won-Gab Byun**, Seoul (KR)

(73) Assignee: **Samsung Electronics Co., Ltd.**, Kyunggi-do (KR)

(**) Term: **14 Years**

(21) Appl. No.: **29/228,023**

(22) Filed: **Apr. 19, 2005**

(51) **LOC (8) Cl.** **14-01**

(52) **U.S. Cl.** **D14/136**

(58) **Field of Classification Search** D14/135–136, D14/156–157, 160–165, 167–168, 192–198, D14/188, 217, 257, 258, 445; 360/99.02, 360/99.07; 369/75.11, 75.21, 77.21, 77.11; 720/612, 619, 647, 655; 455/344, 347–351
See application file for complete search history.

(56) **References Cited**

U.S. PATENT DOCUMENTS

D289,947 S	*	5/1987	Katou et al.	D14/156
4,758,910 A	*	7/1988	Kaneko et al.	360/137
D297,932 S	*	10/1988	Ito et al.	D14/135
D432,513 S	*	10/2000	Takahashi	D14/156
D494,555 S	*	8/2004	Wu	D14/136

OTHER PUBLICATIONS

U.S. Appl. No. 29/217,942, Applicant: Young–Sam Kwon, et al., filed Nov. 23, 2004 entitled Complex Image Player.
U.S. Appl. No. 29/217,943, Applicant: Bong–Chan Ko, et al., filed Nov. 23, 2004 entitled Complex Image Player.
U.S. Appl. No. 29/217,940, Applicant: Young–Sam Kwon, et al., filed Nov. 23, 2004 entitled Complex Image Player.
U.S. Appl. No. 29/217,946, Applicant: Young–Sam Kwon, et al., filed Nov. 23, 2004 entitled DVD Player.
U.S. Appl. No. 29/217,945, Applicant: Young–Sam Kwon, et al., filed Nov. 23, 2004 entitled Double–Deck DVD Recorder.

U.S. Appl. No. 29/217,947, Applicant: Young–Sam Kwon, et al., filed Nov. 23, 2004 entitled Complex Image Player.
U.S. Appl. No. 29/226,437, Applicant: Min–Geun Kim, et al., filed Mar. 29, 2005 entitled Digital Video Recorder.
U.S. Appl. No. 29/228,009, Applicant: Han Kim, et al., filed Apr. 19, 2005 entitled Complex Image Player.
U.S. Appl. No. 29/228,003, Applicant: Hyun–Teak Lim, et al., filed Apr. 19, 2005 entitled DVD Recorder.
U.S. Appl. No. 29/228,001, Applicant: Hyun–Teak Lim, filed Apr. 19, 2005 entitled DVD Recorder.
U.S. Appl. No. 29/228,005, Applicant: Han Kim, et al., filed Apr. 19, 2005 entitled Complex Image Player.
U.S. Appl. No. 29/228,020, Applicant: Hyun–Teak Lim, filed Apr. 19, 2005 entitled DVD Recorder.
U.S. Appl. No. 29/228,006, Applicant: Han Kim, et al., filed Apr. 19, 2005 entitled Complex Image Player.
U.S. Appl. No. 29/228,036, Applicant: Young–Sam Kwon, et al., filed Apr. 19, 2005 entitled Complex Image Player.
U.S. Appl. No. 29/227,995, Applicant: Hyun–Teak Lim, et al., filed Apr. 19, 2005 entitled DVD Player.
U.S. Appl. No. 29/228,002, Applicant: Hyun–Teak Lim, filed Apr. 19, 2005 entitled Blu–Ray Player.

(Continued)

Primary Examiner—Nanda Bondade
(74) *Attorney, Agent, or Firm*—Flynn, Thiel, Boutell & Tanis, P.C.

(57) **CLAIM**

The ornamental design for a blu-ray player, as shown and described.

DESCRIPTION

FIG. 1. is a top front perspective view of a blu-ray player showing our new design.
FIG. 2. is a front elevational view thereof.
FIG. 3. is a rear elevational view thereof.
FIG. 4 is a left side elevational view thereof, the right side view being a mirror image thereof.
FIG. 5. is a top plan view thereof; and,
FIG. 6. is a bottom plan view thereof.

1 Claim, 5 Drawing Sheets

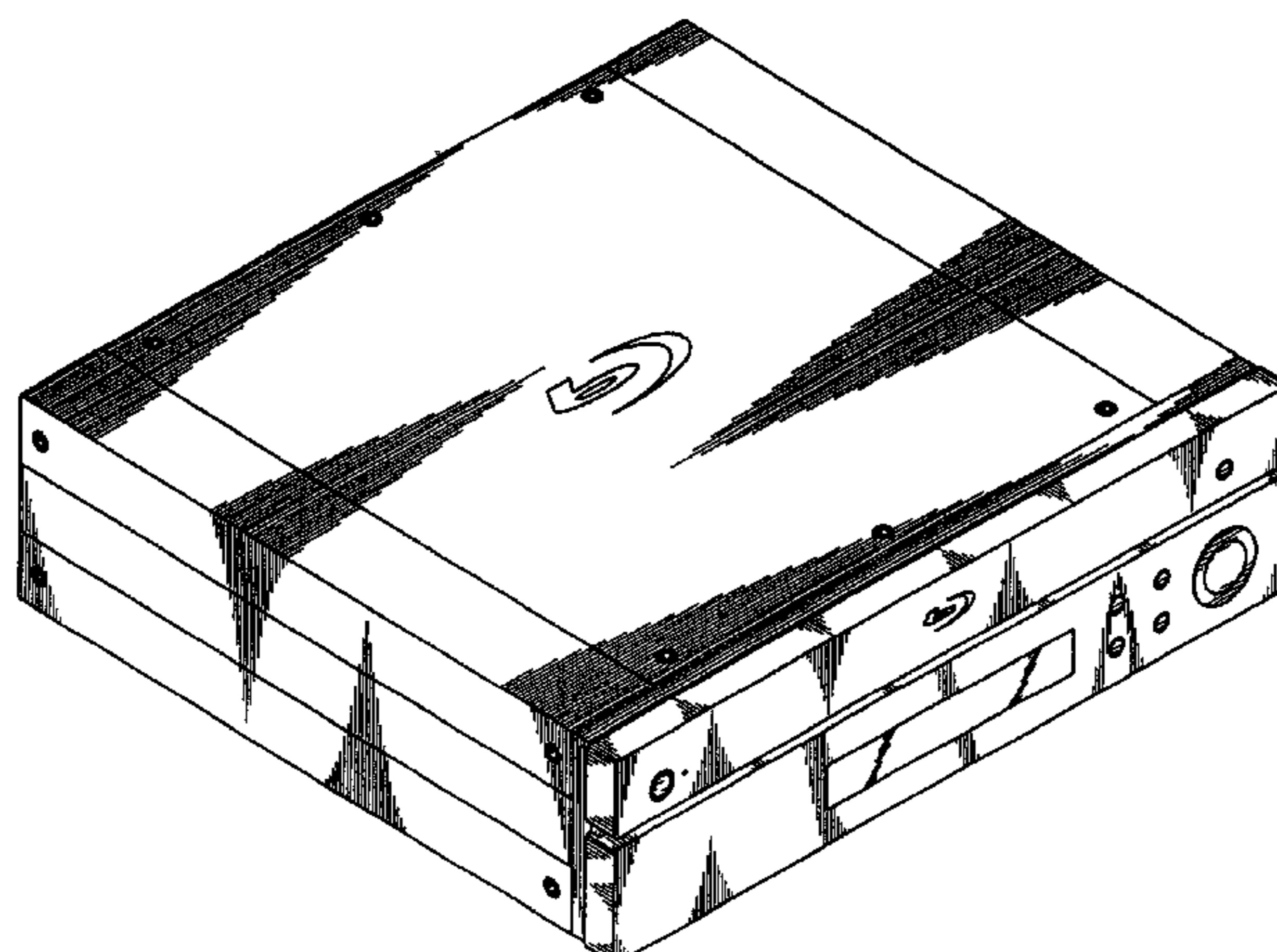

OTHER PUBLICATIONS

U.S. Appl. No. 29/228,008, Applicant: Young-Sam Kwon, et al., filed Apr. 19, 2005 entitled Complex Image Player.

U.S. Appl. No. 29/228,033, Applicant: Young-Sam Kwon, et al., filed Apr. 19, 2005 entitled Complex Image Player.

U.S. Appl. No. 29/228,011, Applicant: Young-Sam Kwon, et al., filed Apr. 19, 2005 entitled Complex Image Player.

U.S. Appl. No. 29/228,000, Applicant: Young-Sam Kwon, et al., filed Apr. 19, 2005 entitled DVD Player.

* cited by examiner

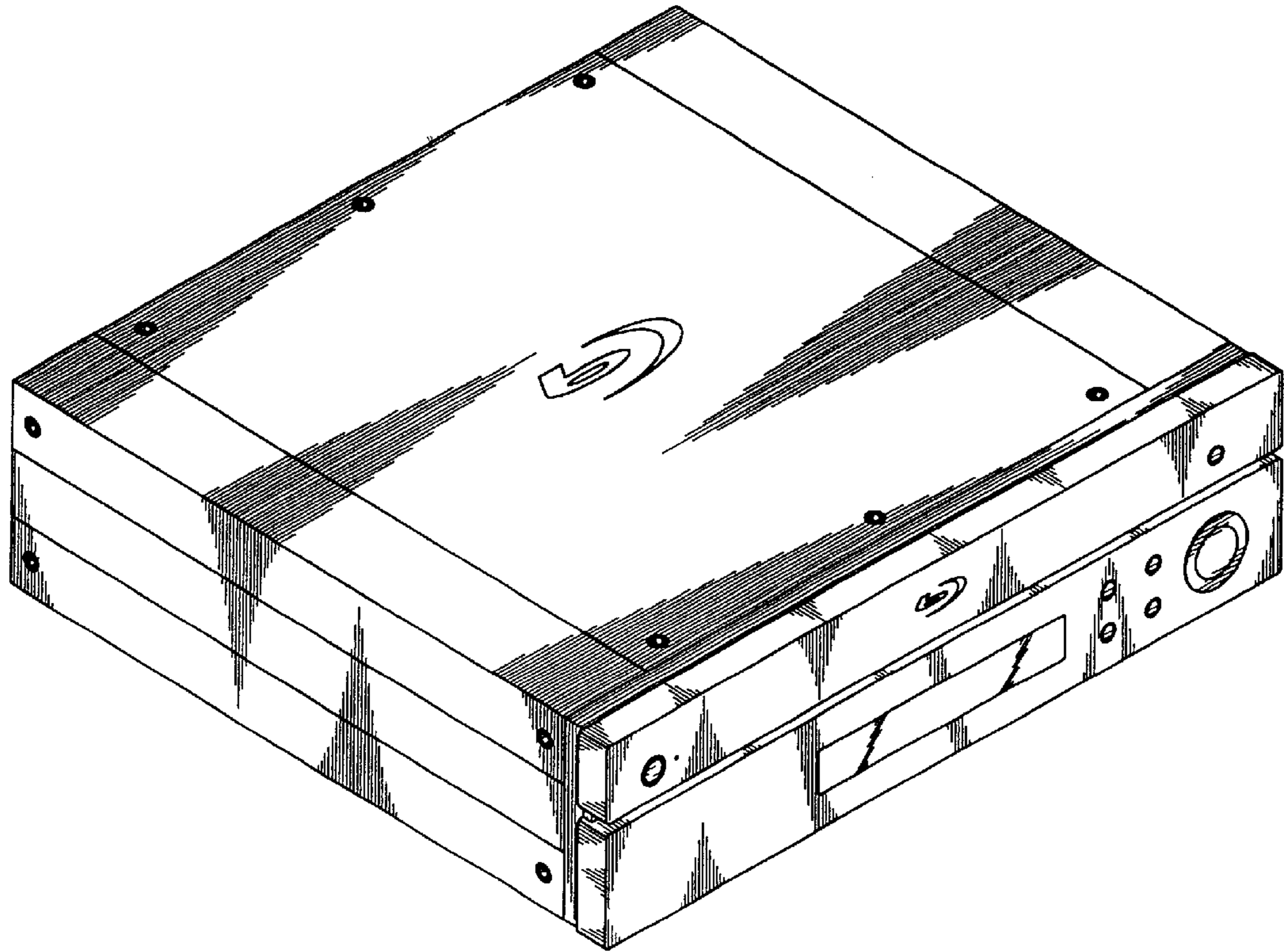

FIG. 1

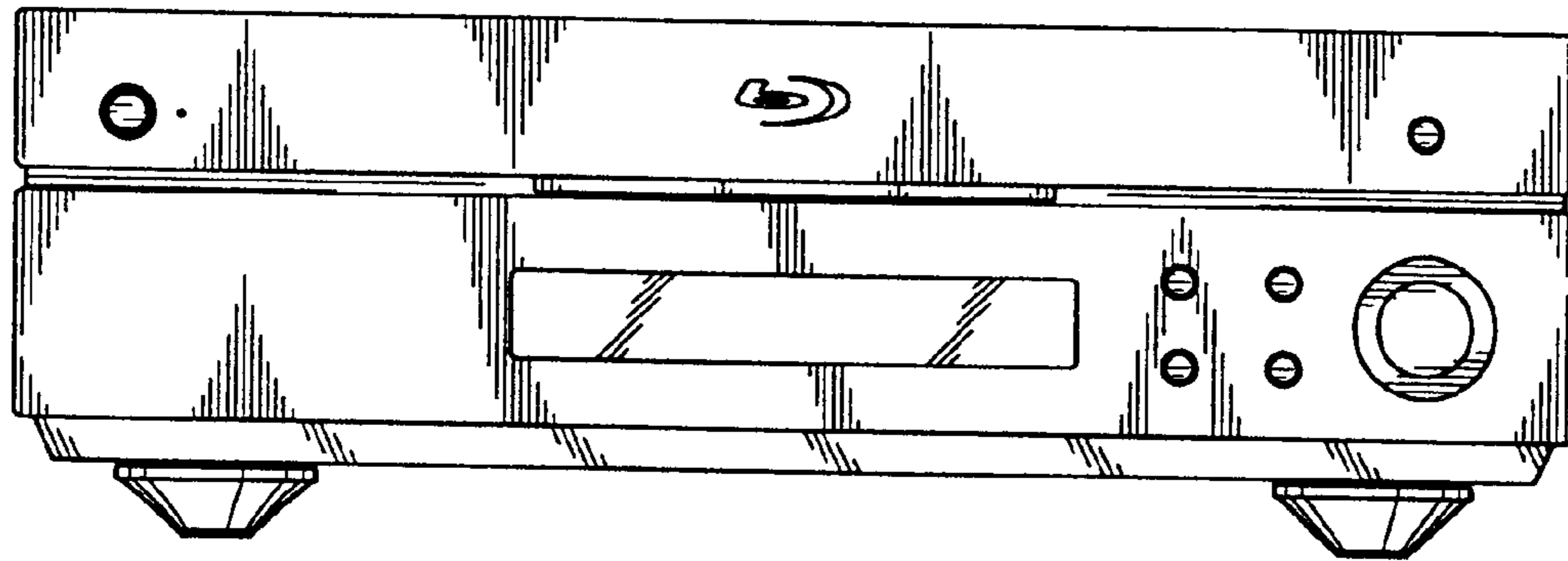

FIG. 2

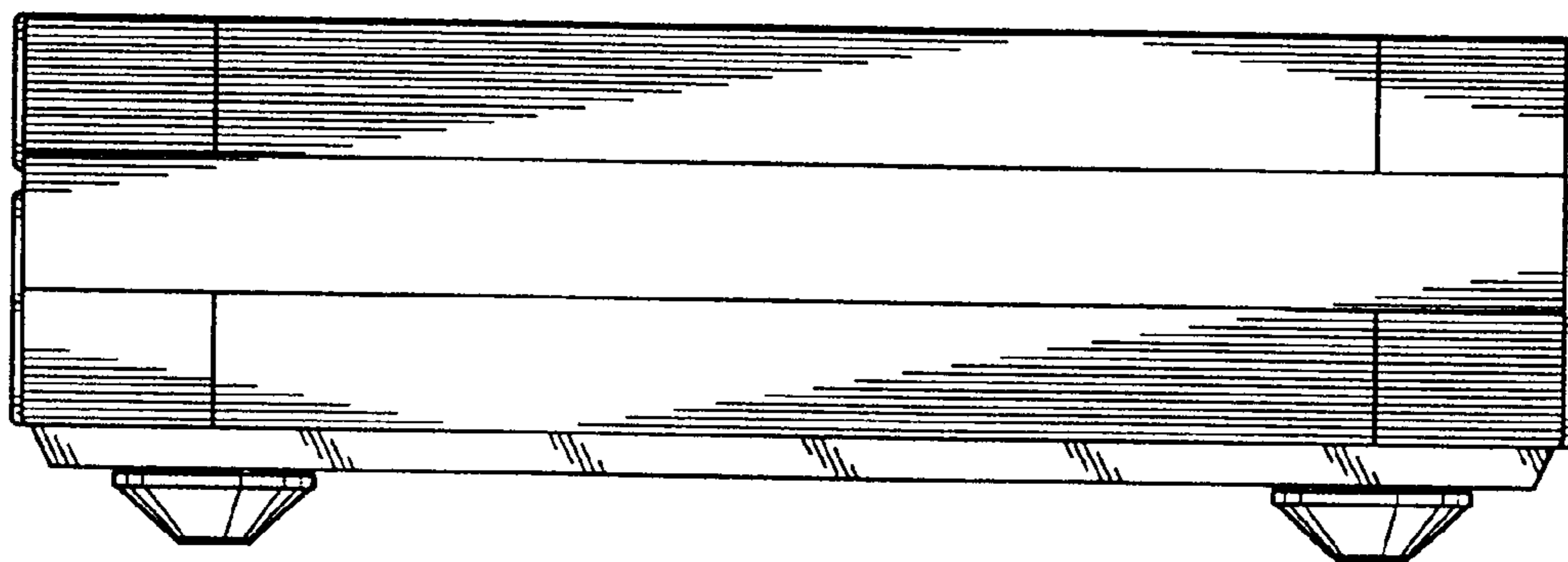

FIG. 3

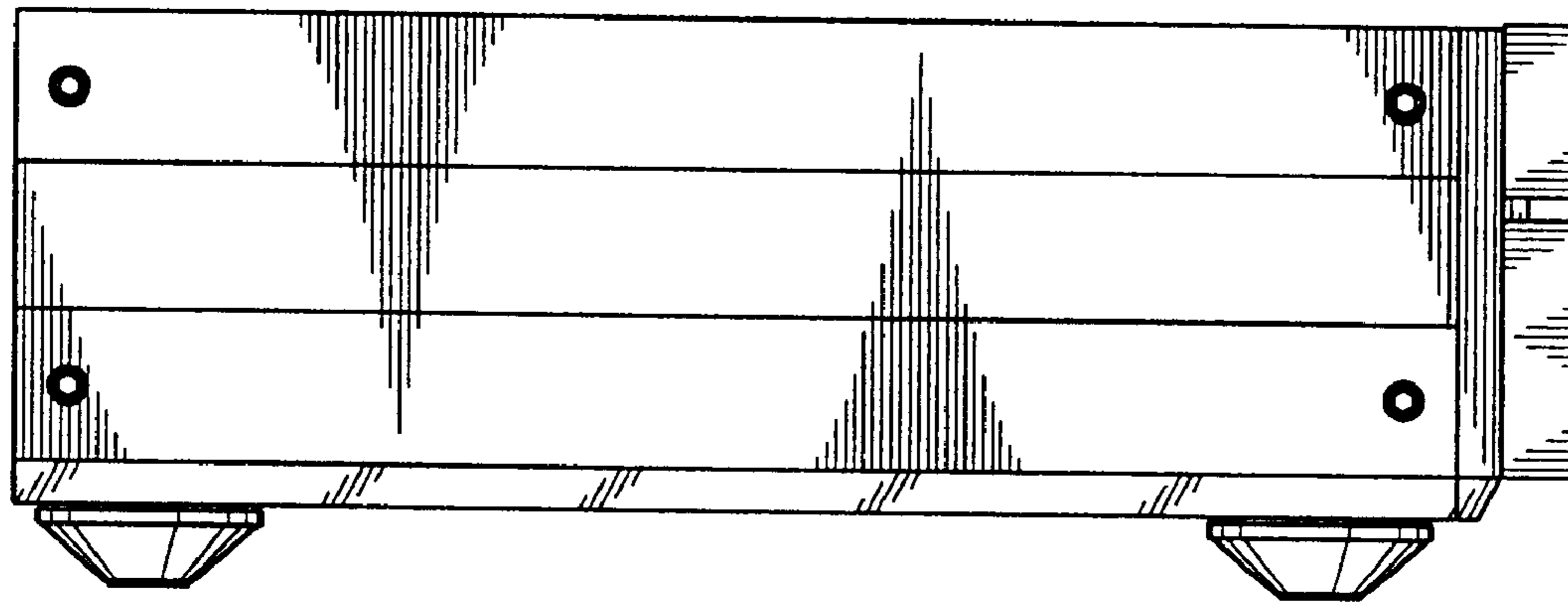

FIG. 4

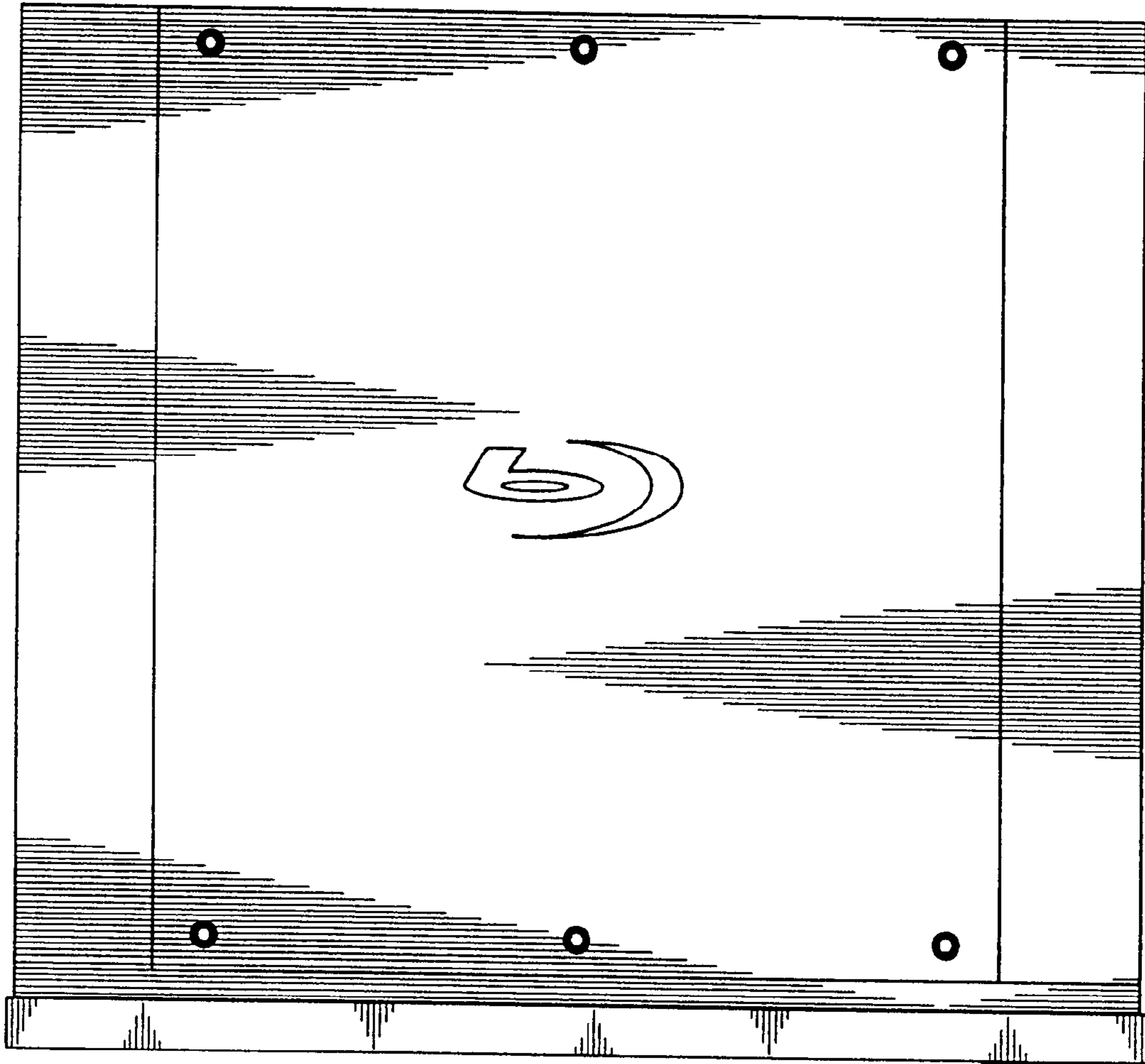

FIG. 5

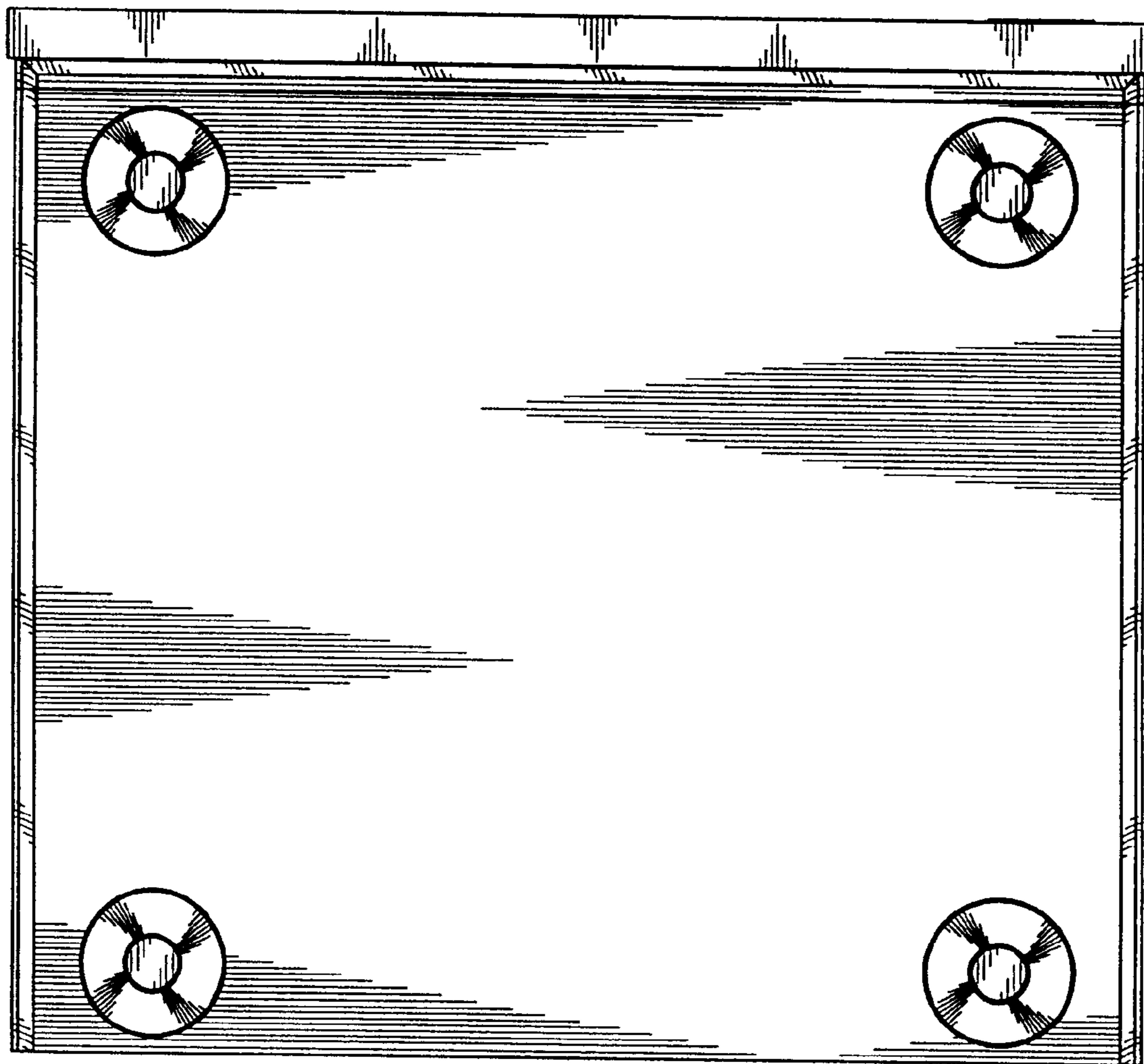

FIG. 6