



US00D520969S

(12) **United States Design Patent**
Lin

(10) **Patent No.:** **US D520,969 S**

(45) **Date of Patent:** **** May 16, 2006**

(54) **TELEVISION SET**

(75) Inventor: **Roger Lin**, Taipei (TW)

(73) Assignee: **Hannspree, Inc.**, Taipei (TW)

(**) Term: **14 Years**

(21) Appl. No.: **29/230,141**

(22) Filed: **May 18, 2005**

(30) **Foreign Application Priority Data**

Dec. 9, 2004 (TW) 93307483

(51) **LOC (8) Cl.** **14-03**

(52) **U.S. Cl.** **D14/126; D14/129**

(58) **Field of Classification Search** D14/125-134,
D14/239, 371, 136, 374-377; 312/7.2; 348/836,
348/838, 180, 184, 325, 739; 341/12; 248/917-924,
248/465; 345/104, 133, 156, 168, 87, 173;
720/605, 669, 600, 655; 369/99, 197; 455/344-347
See application file for complete search history.

(56) **References Cited**

U.S. PATENT DOCUMENTS

D317,912 S * 7/1991 Takai D14/375

D416,587 S * 11/1999 Hornsby et al. D21/329

D460,113 S * 7/2002 Hainey et al. D19/52

D483,757 S * 12/2003 Olson et al. D14/371

D496,047 S * 9/2004 Hoehn D14/375

D508,244 S * 8/2005 Fairhurst et al. D14/346

* cited by examiner

Primary Examiner—Raphael Barkai

(74) *Attorney, Agent, or Firm*—Posz Law Group, PLC; R. Eugene Varndell, Jr.

(57) **CLAIM**

The ornamental design for a television set, as shown.

DESCRIPTION

FIG. 1 is a perspective view of a television set showing my new design;

FIG. 2 is a front view thereof;

FIG. 3 is a rear view thereof;

FIG. 4 is a left view thereof;

FIG. 5 is a right view thereof;

FIG. 6 is a top view thereof; and,

FIG. 7 is a bottom view thereof.

1 Claim, 6 Drawing Sheets

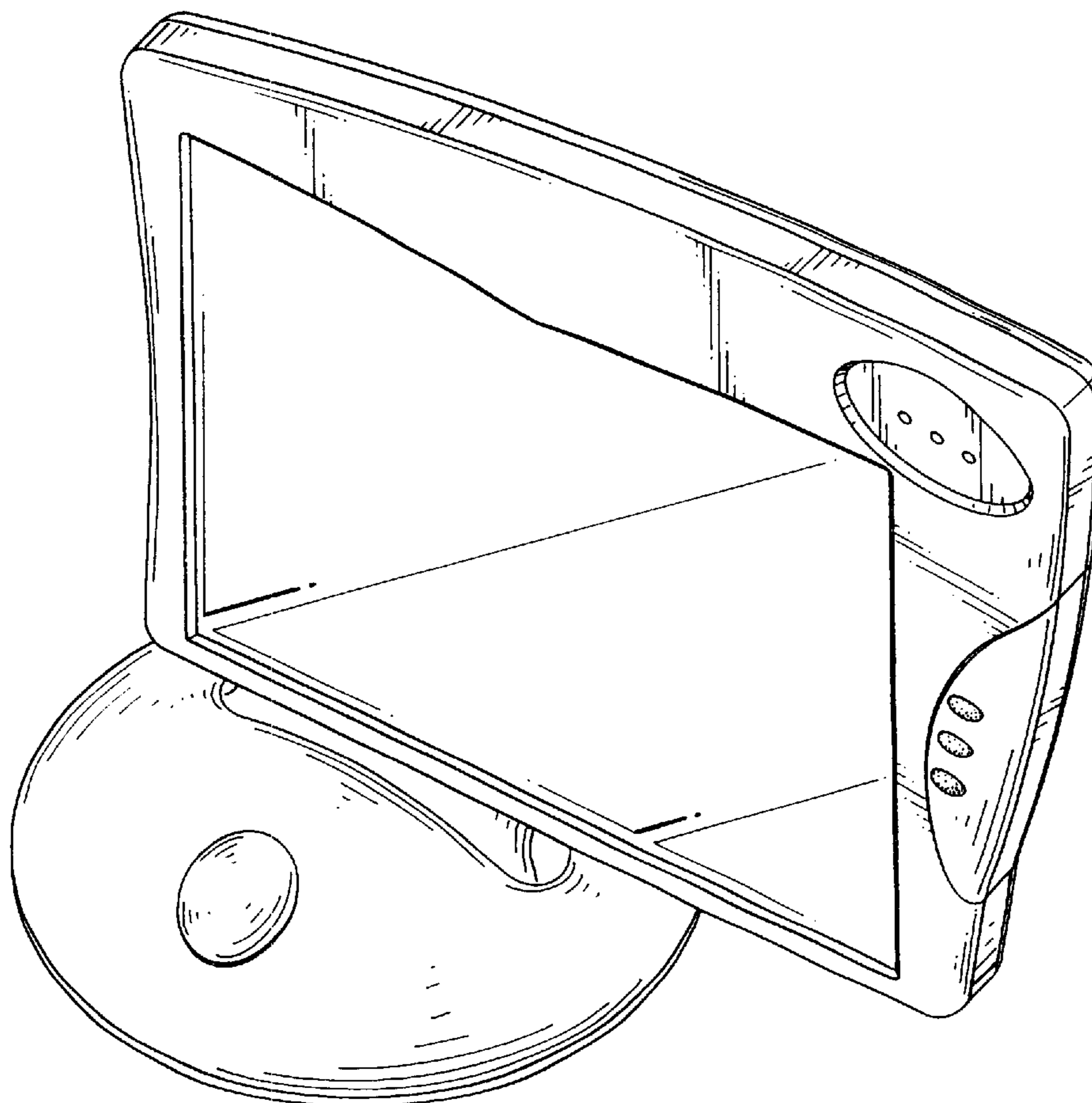

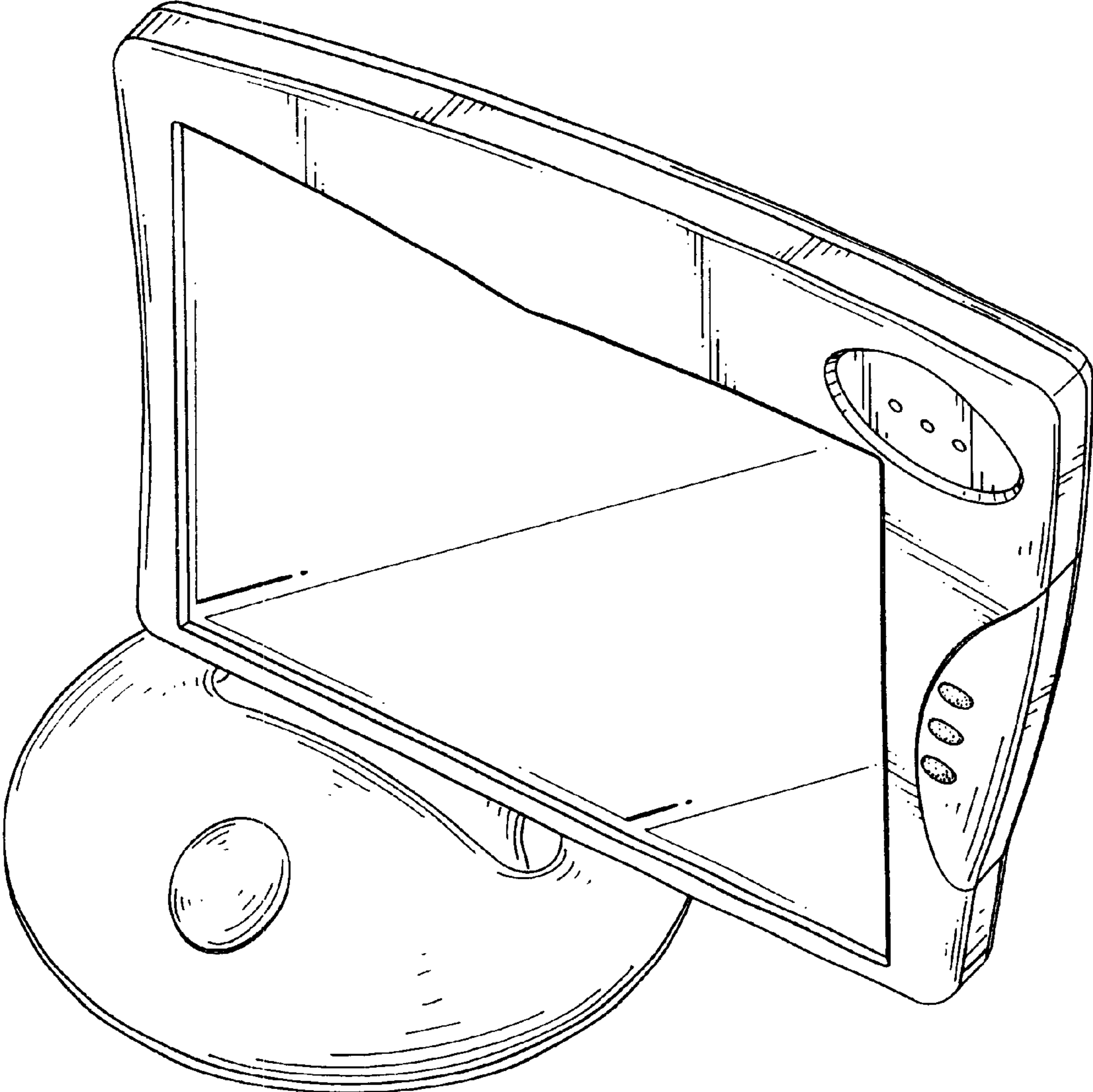

FIG.1

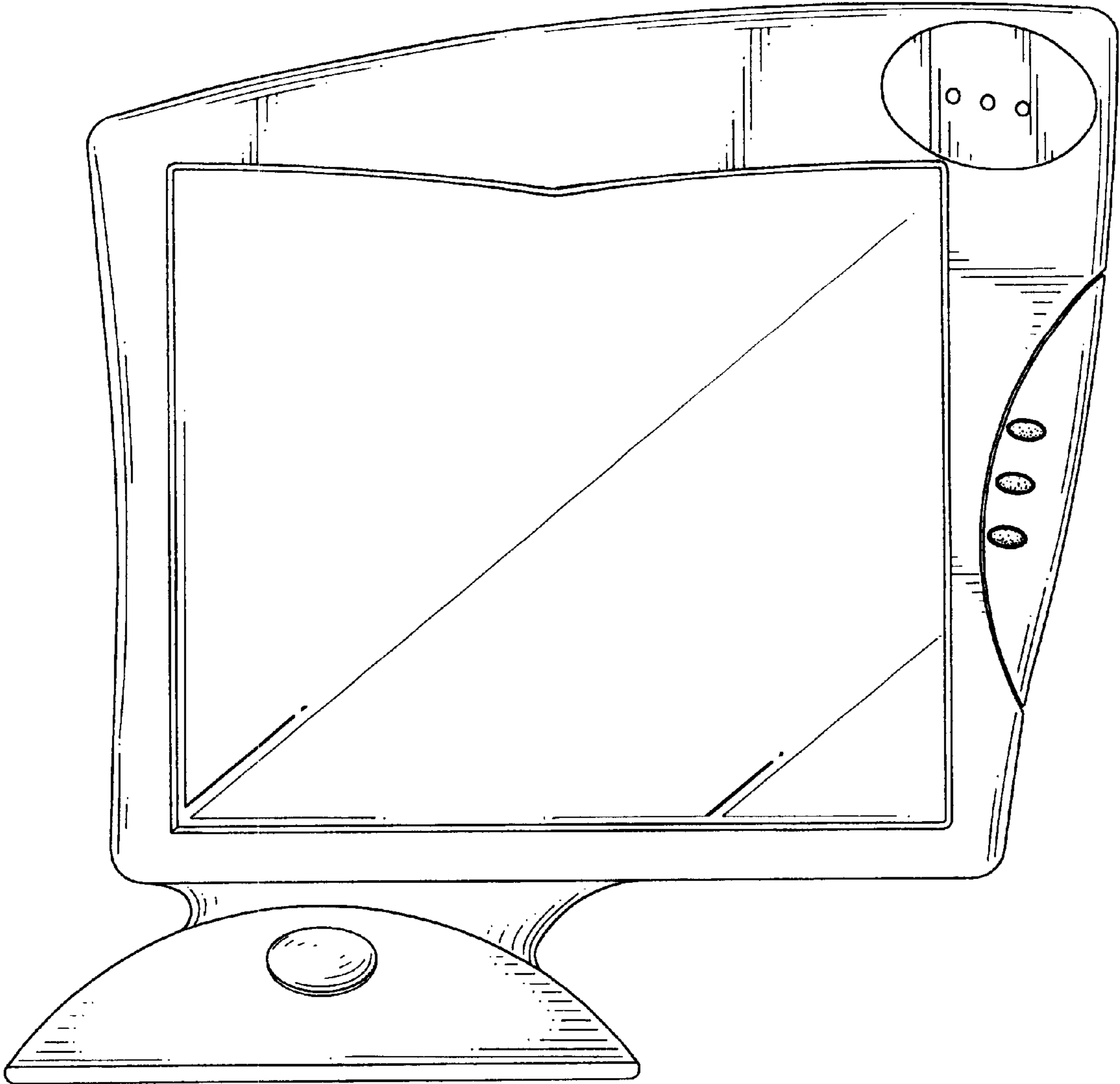

FIG.2

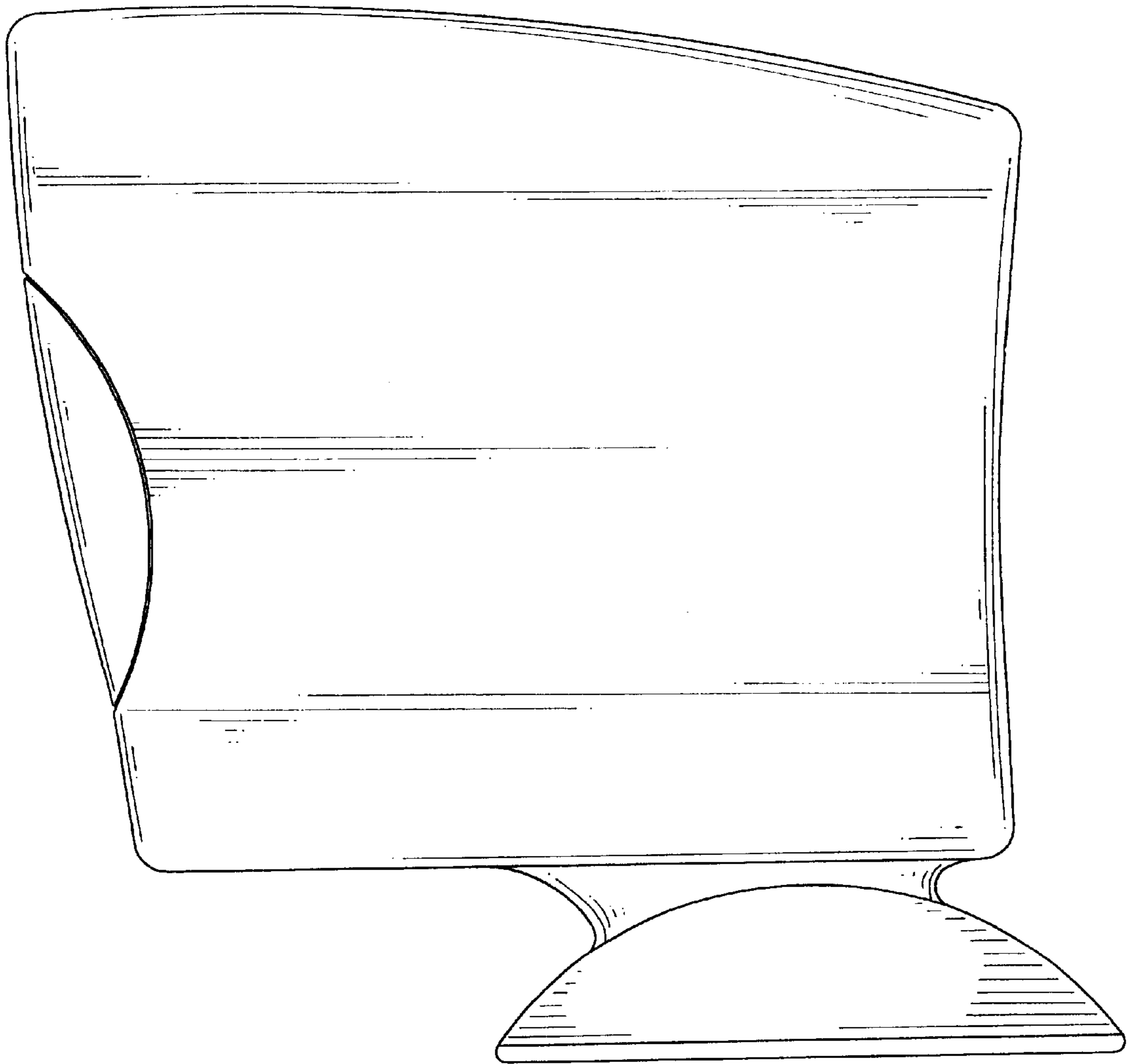

FIG. 3

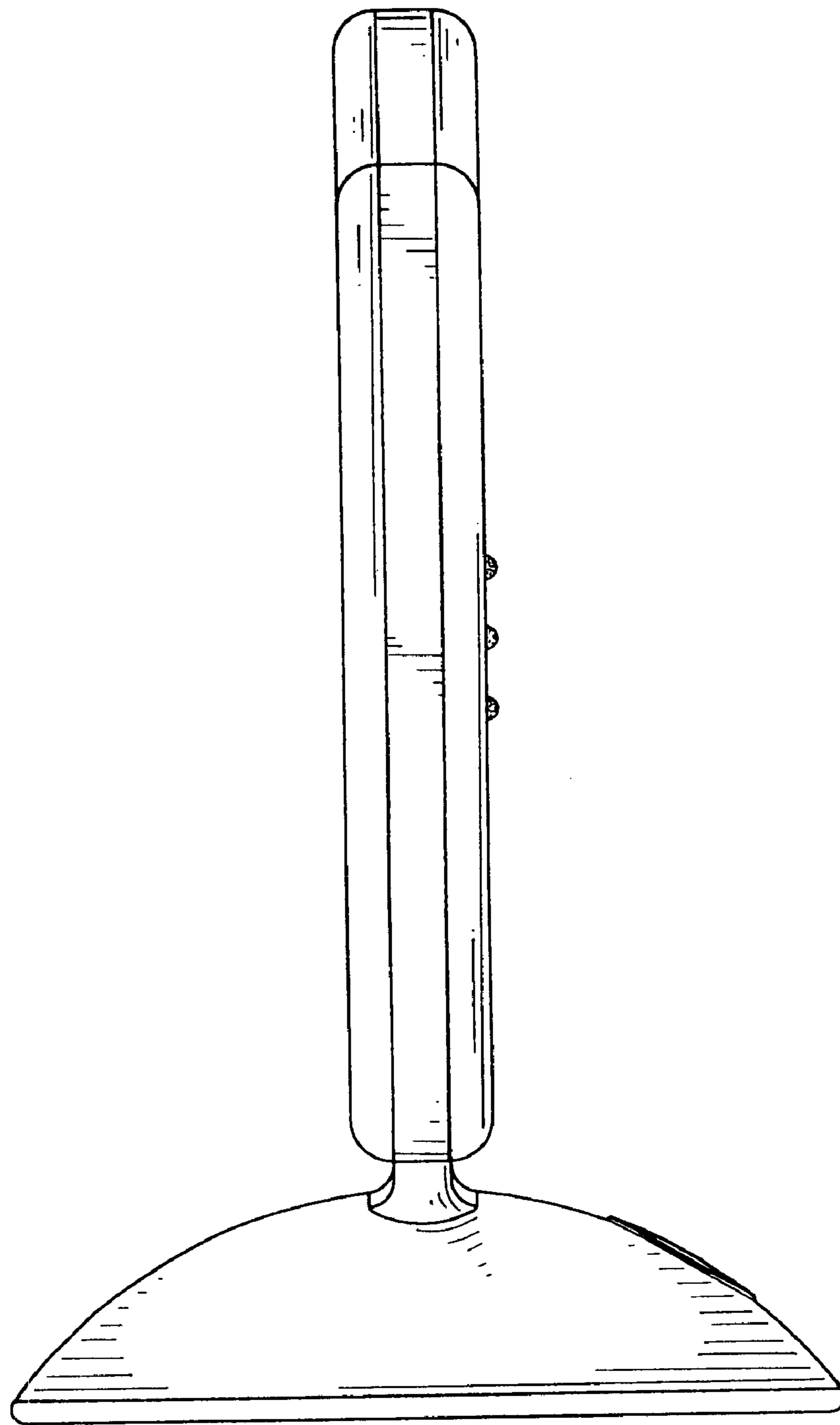

FIG.4

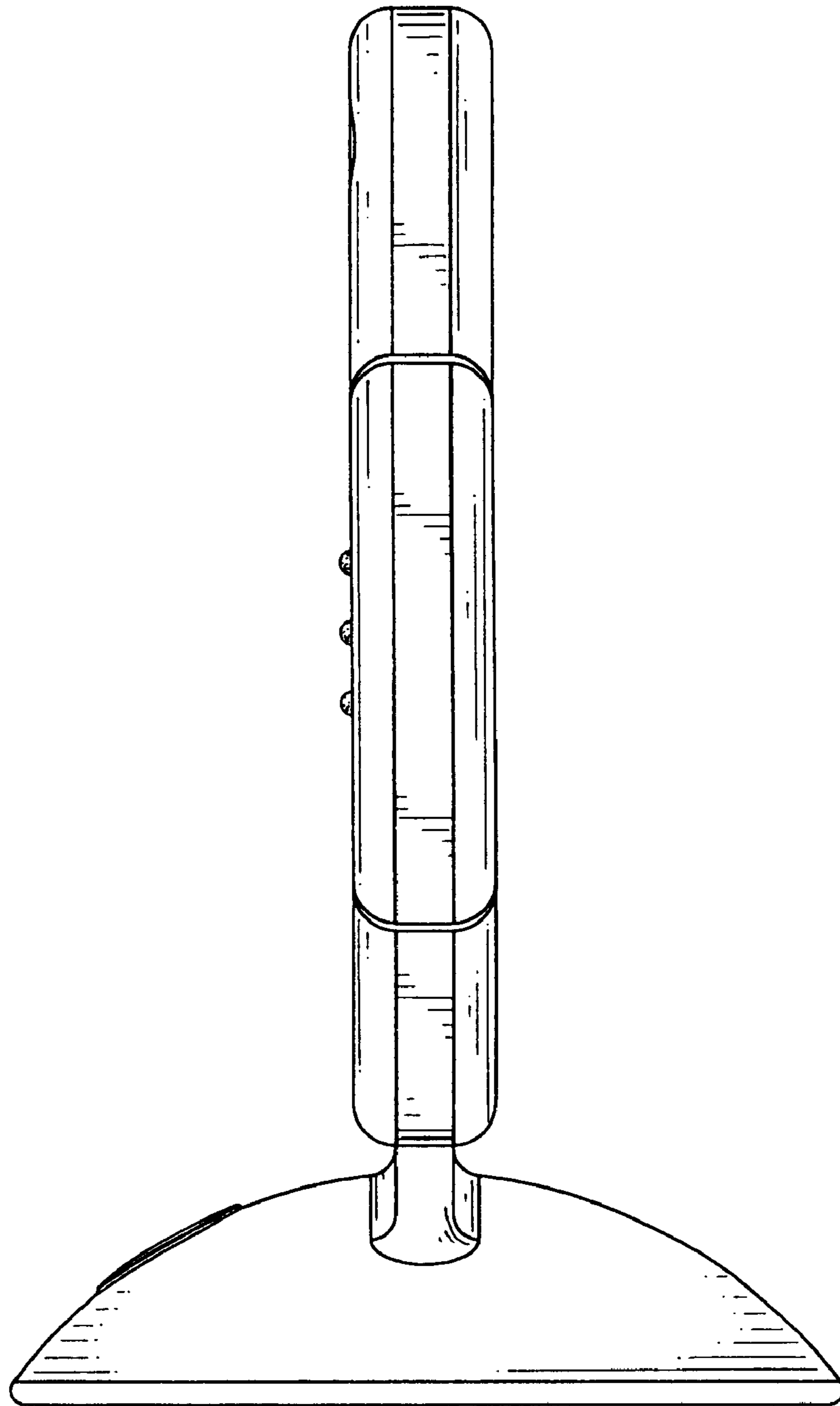

FIG.5

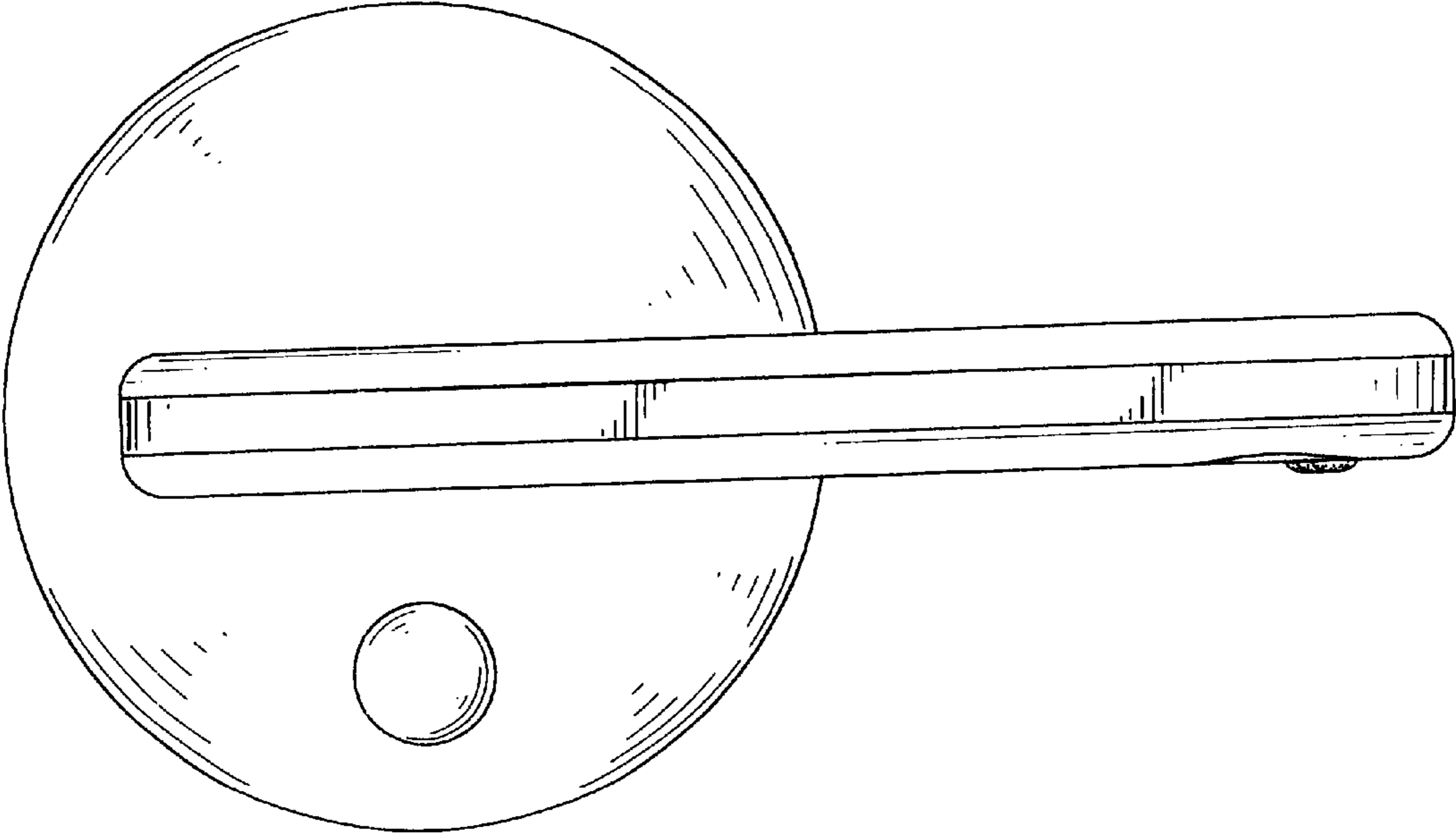

FIG.6

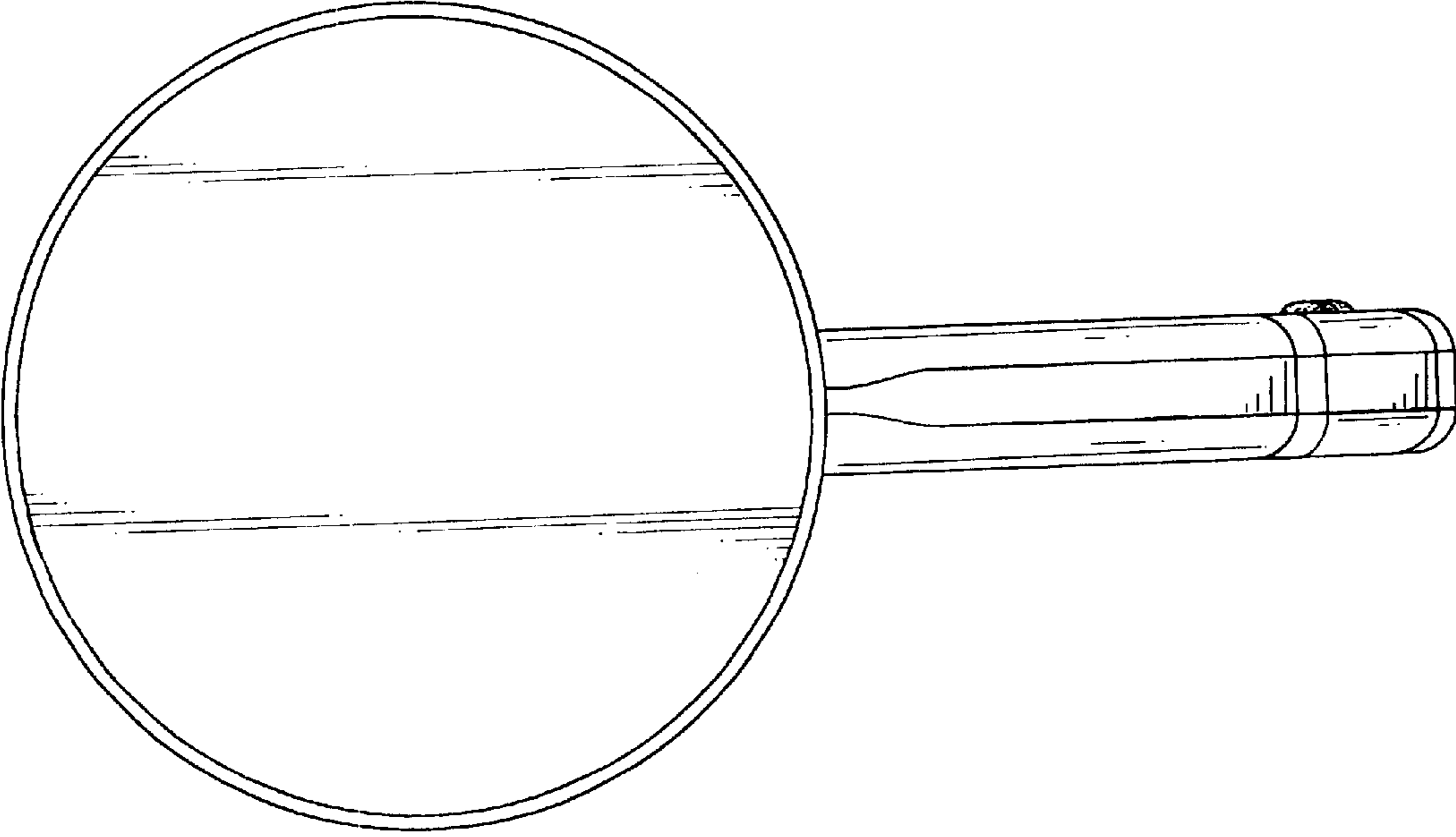

FIG.7