



US00D520832S

(12) **United States Design Patent** (10) **Patent No.:** **US D520,832 S**  
**Ozawa et al.** (45) **Date of Patent:** **\*\* May 16, 2006**

(54) **PORTABLE ELECTRIC DRIVER** 6,745,883 B1 \* 6/2004 Eto et al. .... 173/178  
D494,435 S \* 8/2004 Hayakawa et al. .... D8/68  
(75) Inventors: **Takashi Ozawa**, Hitachinaka (JP); D499,945 S \* 12/2004 Sugawara et al. .... D8/68  
**Yoshitaka Suzuki**, Wako (JP); D504,111 S \* 4/2005 Ozawa et al. .... D13/103  
**Katsuhiro Oomori**, Hitachinaka (JP); D508,642 S \* 8/2005 Kokawa et al. .... D8/68  
**Yoshihiro Komuro**, Hitachinaka (JP) 2002/0122707 A1 \* 9/2002 Sakai et al. .... 408/241 R  
2003/0159843 A1 \* 8/2003 Sakai et al. .... 173/217  
2005/0022638 A1 \* 2/2005 Milbourne et al. .... 81/466  
(73) Assignee: **Hitachi Koki Co., Ltd.**, Tokyo (JP) 2005/0121209 A1 \* 6/2005 Shimizu et al. .... 173/217  
2005/0155778 A1 \* 7/2005 Ishida et al. .... 173/217  
(\*\*) Term: **14 Years**

FOREIGN PATENT DOCUMENTS

JP 1214971 S 8/2004

\* cited by examiner

*Primary Examiner*—Gary D. Watson  
*Assistant Examiner*—T. Chase Nelson  
(74) *Attorney, Agent, or Firm*—Sughrue Mion, PLLC

(21) Appl. No.: **29/230,804**  
(22) Filed: **May 27, 2005**  
(30) **Foreign Application Priority Data**  
Nov. 30, 2004 (JP) ..... 2004-036496  
(51) **LOC (8) Cl.** ..... **08-05**  
(52) **U.S. Cl.** ..... **D8/68**  
(58) **Field of Classification Search** ..... D8/14.1,  
D8/61, 62, 63, 64, 65, 66, 67, 68, 69, 70;  
81/57.11, 429, 464, 465, 466, 469, 489; 173/13,  
173/169, 178, 213, 217, 114, 201, 211; 227/8,  
227/114, 120, 130, 136, 142; 408/20, 124,  
408/125, 234, 241 R; 451/358; 310/50  
See application file for complete search history.

(57) **CLAIM**

The ornamental design for a portable electric driver, as shown.

**DESCRIPTION**

FIG. 1 is a perspective view of the top, front and left side of a portable electric driver showing our new design; FIG. 2 is a front elevational view thereof; FIG. 3 is a rear elevational view thereof; FIG. 4 is a left side elevational view thereof; FIG. 5 is a right side elevational view thereof; FIG. 6 is a top plan view thereof; and, FIG. 7 is a bottom plan view thereof.

(56) **References Cited**  
U.S. PATENT DOCUMENTS  
D392,863 S \* 3/1998 Sugimoto et al. .... D8/68  
D437,761 S \* 2/2001 Okumura et al. .... D8/68  
D477,205 S \* 7/2003 Sakai et al. .... D8/68  
D484,385 S \* 12/2003 Sakai et al. .... D8/68

**1 Claim, 5 Drawing Sheets**

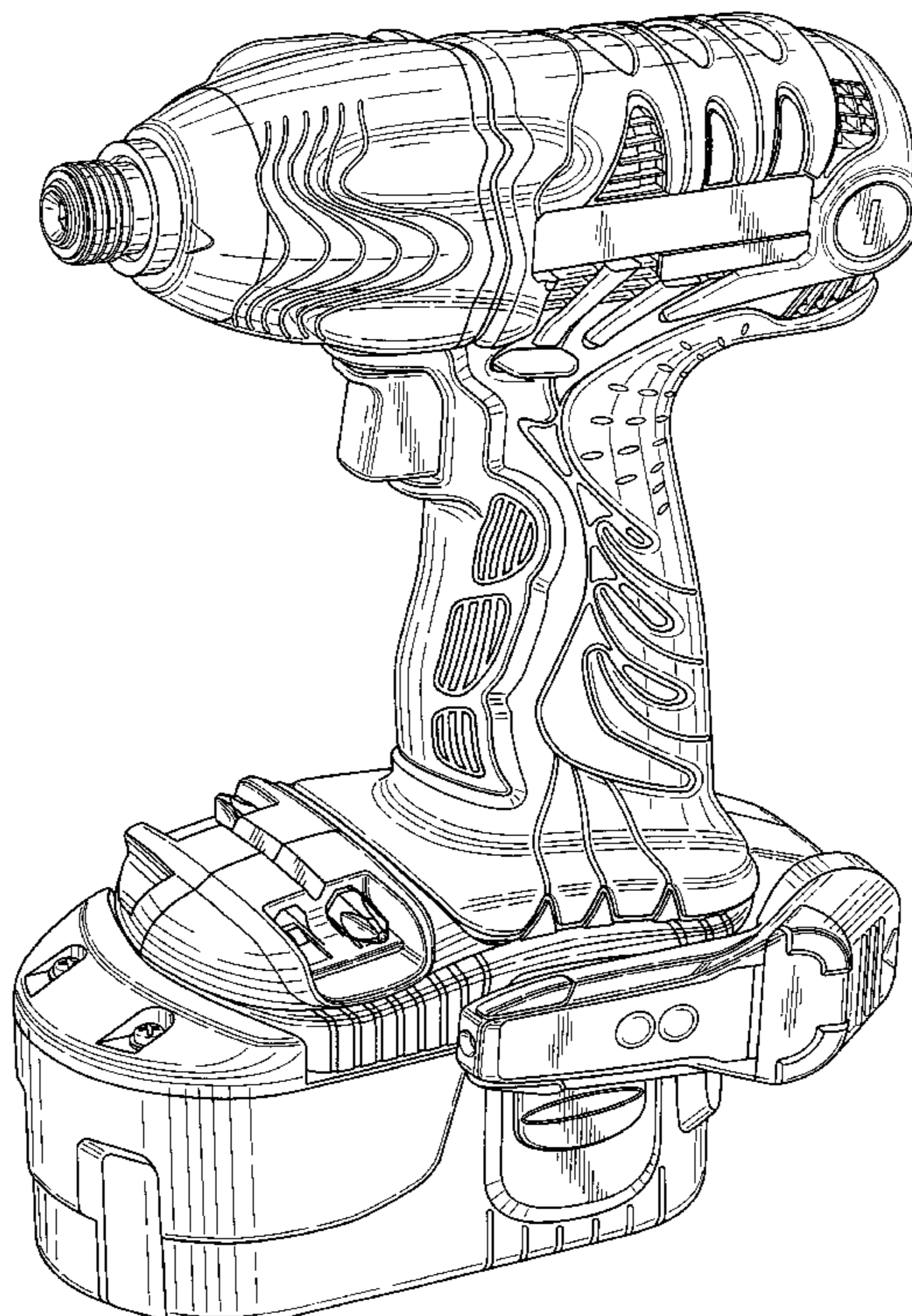

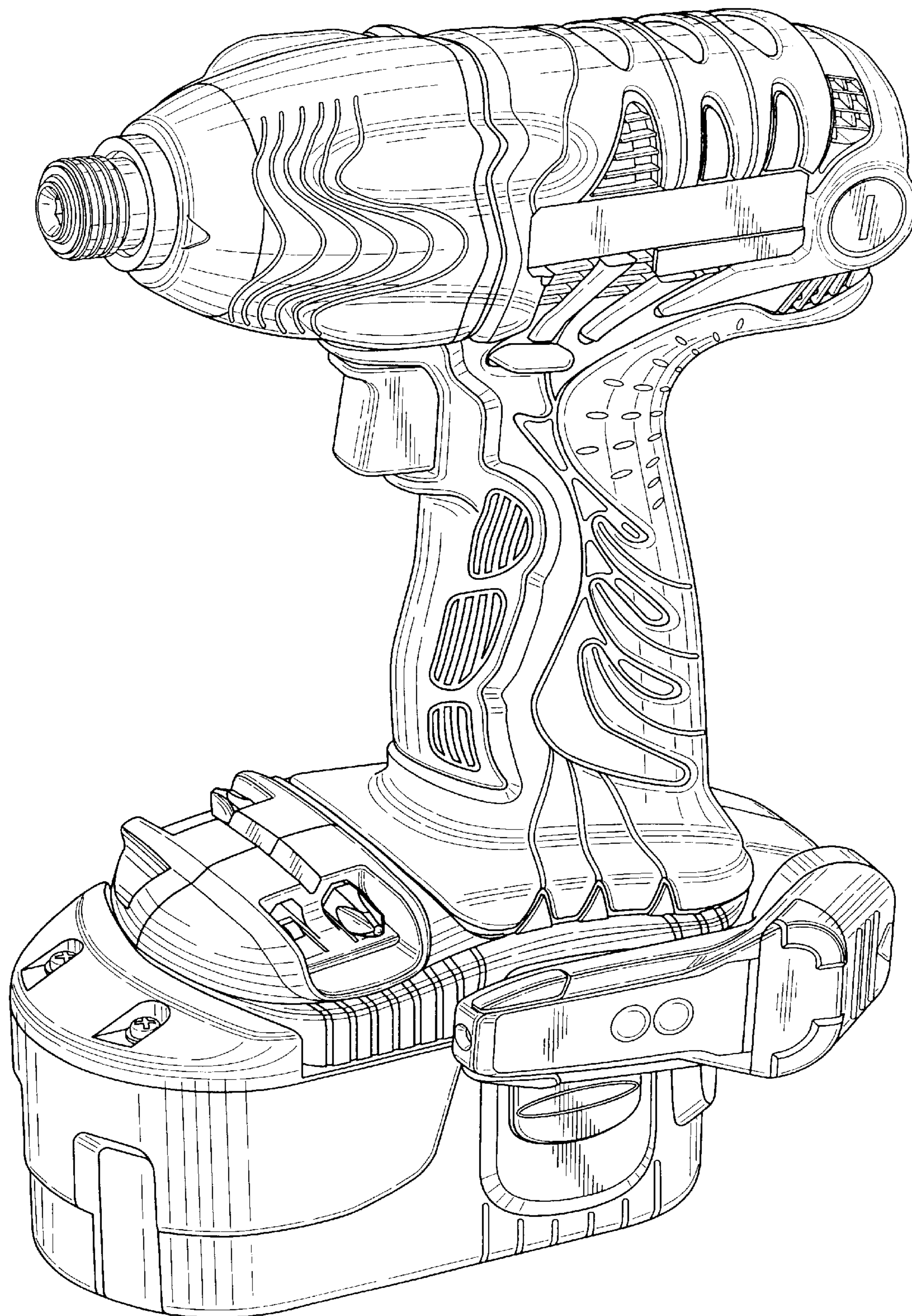

**FIG. 1**



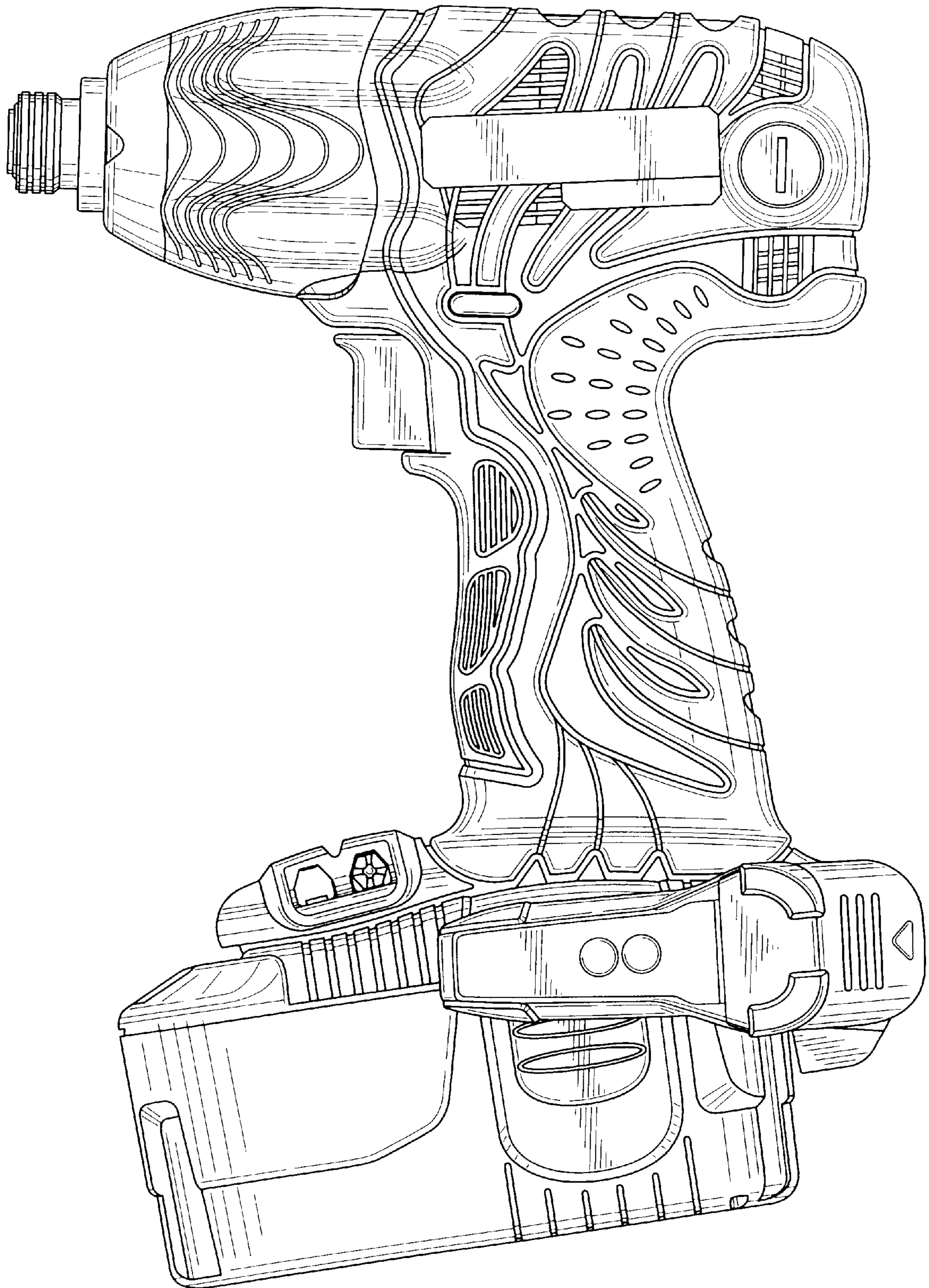

FIG. 2

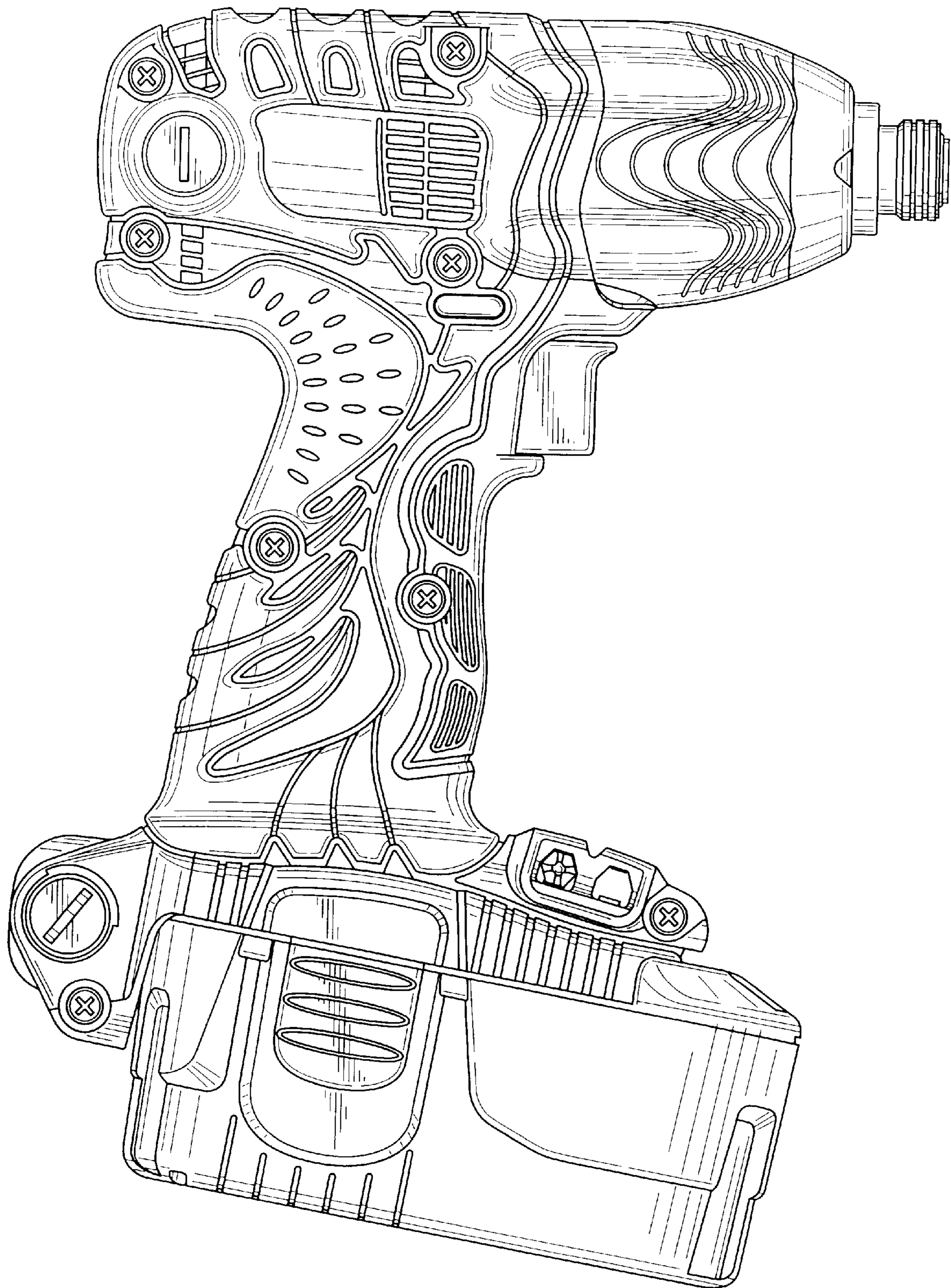

FIG. 3



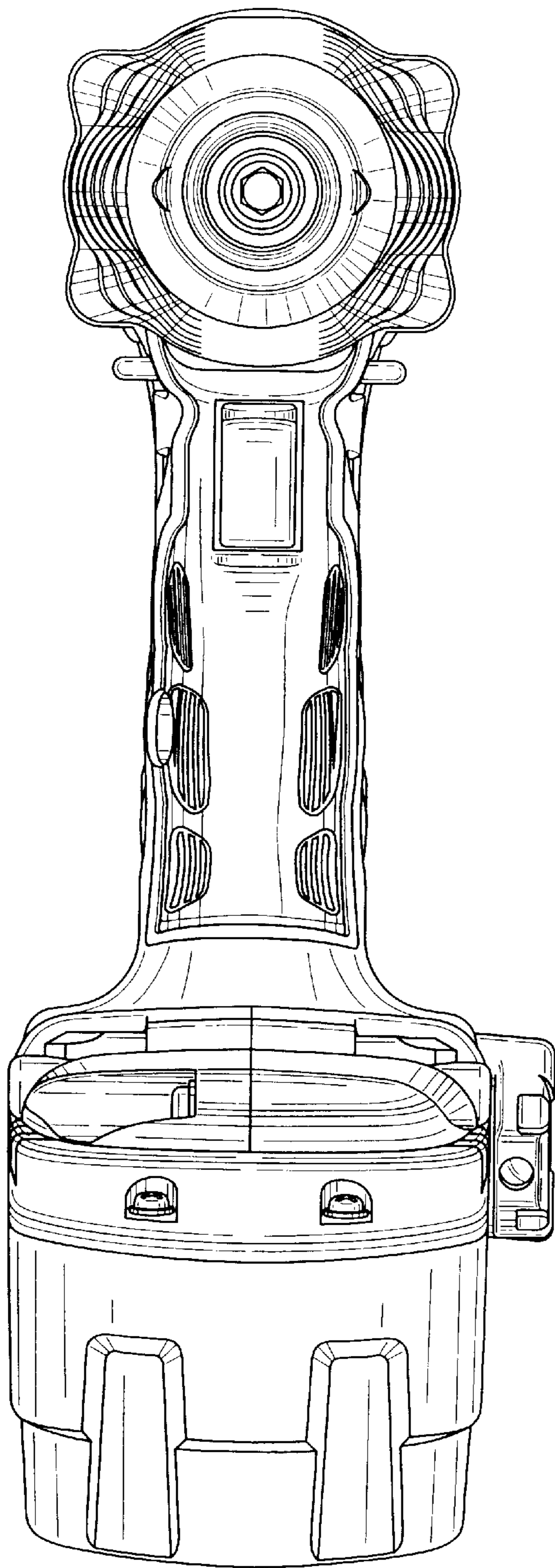

FIG. 4

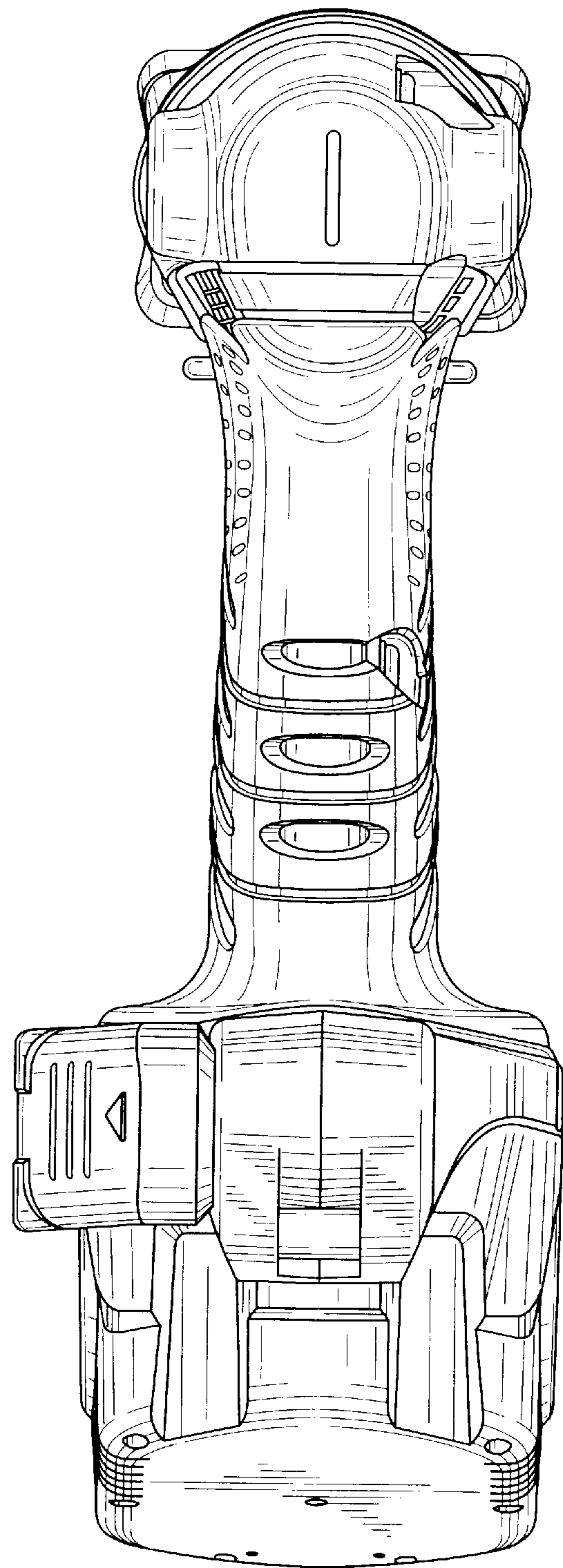
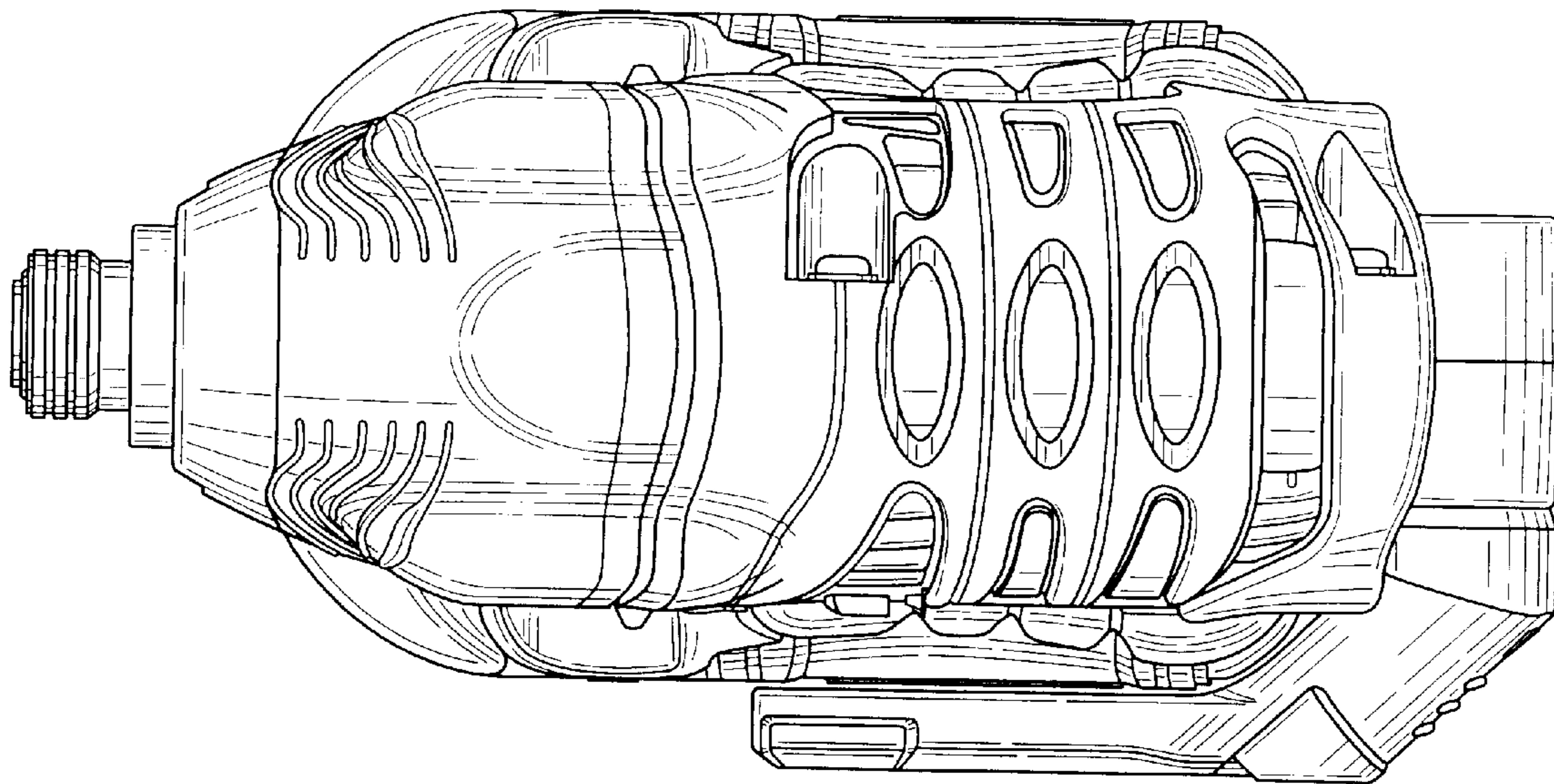
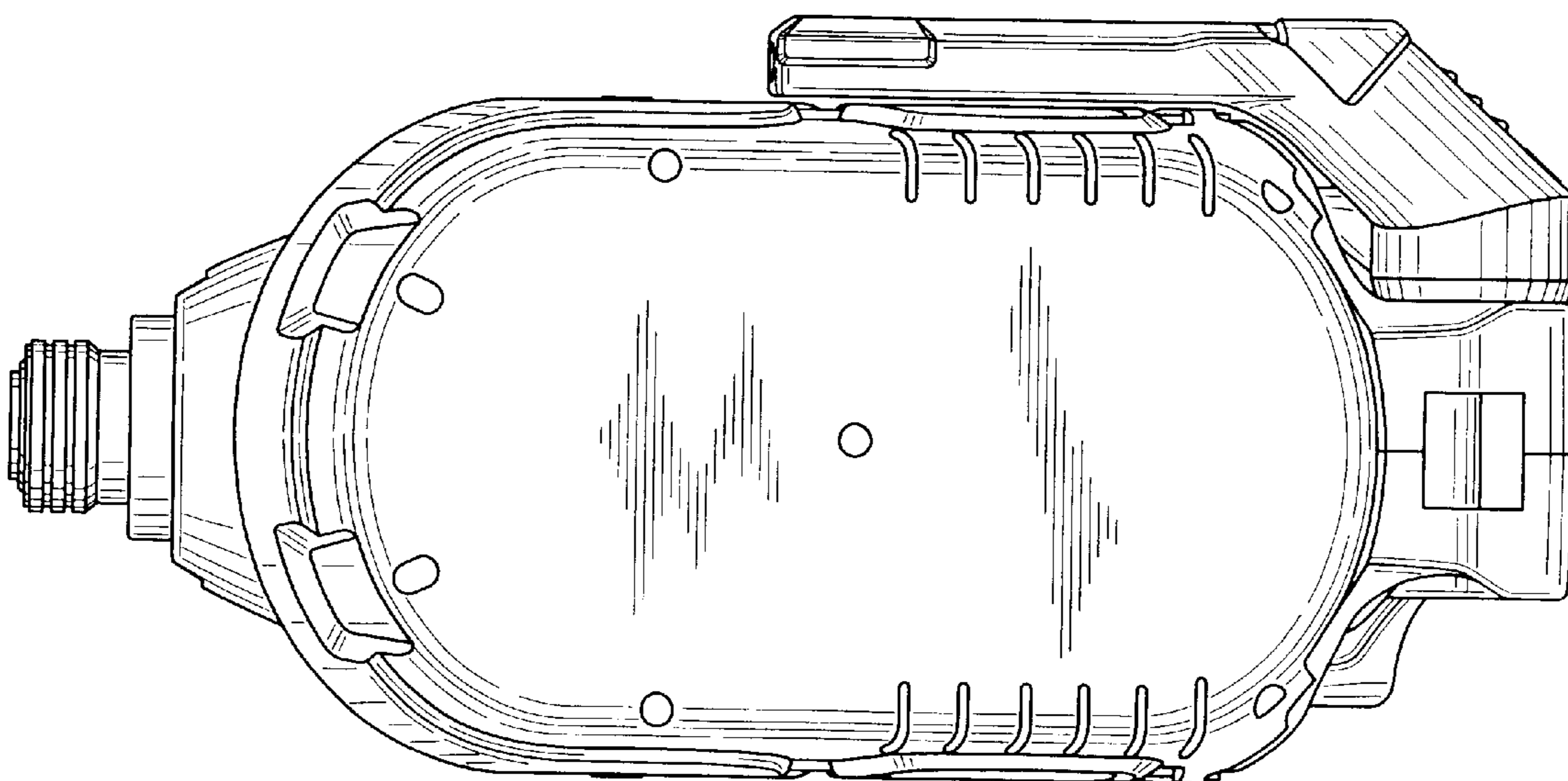

FIG. 5



*FIG. 6*



*FIG. 7*