

US00D520820S

(12) **United States Design Patent**
Chang et al.

(10) **Patent No.:** **US D520,820 S**
(45) **Date of Patent:** **** May 16, 2006**

(54) **SURE GRIPS FOR A CAULK DISPENSING DEVICE**
(76) Inventors: **Peter J. Y. Chang**, 11001 Petersborough Dr., Rockville, MD (US) 20852; **Albert Lee**, 5916 Perfect Calm Ct., Clarksville, MD (US) 21029

(**) **Term:** **14 Years**
(21) **Appl. No.:** **29/206,459**
(22) **Filed:** **May 28, 2004**

(51) **LOC (8) Cl.** **08-05**
(52) **U.S. Cl.** **D8/14.1**
(58) **Field of Classification Search** D8/14.1; 222/309
See application file for complete search history.

(56) **References Cited**

U.S. PATENT DOCUMENTS

D246,221 S	*	11/1977	Cox	D8/14.1
D285,895 S	*	9/1986	Cox	D8/14.1
D343,557 S	*	1/1994	Lin	D8/14.1
D354,208 S	*	1/1995	Vega	D8/14.1
D369,285 S	*	4/1996	Leech	D8/14.1
D388,672 S	*	1/1998	Kelders et al.	D8/14.1
D413,235 S	*	8/1999	Hwang	D8/14.1

* cited by examiner

Primary Examiner—Holly Baynham
(74) *Attorney, Agent, or Firm*—Law Offices of Royal W. Craig

(57) **CLAIM**
The ornamental design for sure grips for a caulk dispensing device.

DESCRIPTION
FIG. 1 is a front perspective view of the sure-grips for caulk dispensing devices according to a preferred embodiment of our new design.
FIG. 2 is a side perspective view of the sure-grips as in FIG. 1.
FIG. 3 is a rear perspective view of the sure-grips as in FIGS. 1–2.
FIG. 4 is a front view of the front trigger grip as in FIGS. 1–3.
FIG. 5 is a side view of the front trigger grip as in FIGS. 1–4.
FIG. 6 is a top view of the front trigger grip as in FIGS. 1–5.
FIG. 7 is a front view of the rear handle grip as in FIGS. 1–3.
FIG. 8 is a side view of the rear handle grip as in FIGS. 1–3 and 7; and,
FIG. 9 is a top view of the rear handle grip as in FIGS. 1–3 and 7–8.
Solid black surface shading is used to represent color contrast inasmuch as the sure-grips are preferably two-tone. The broken line showing of the body of a caulk dispenser is for illustrative purposes only and forms no part of the claimed design. The sure grips are show separate for clarity of illustration.

1 Claim, 5 Drawing Sheets

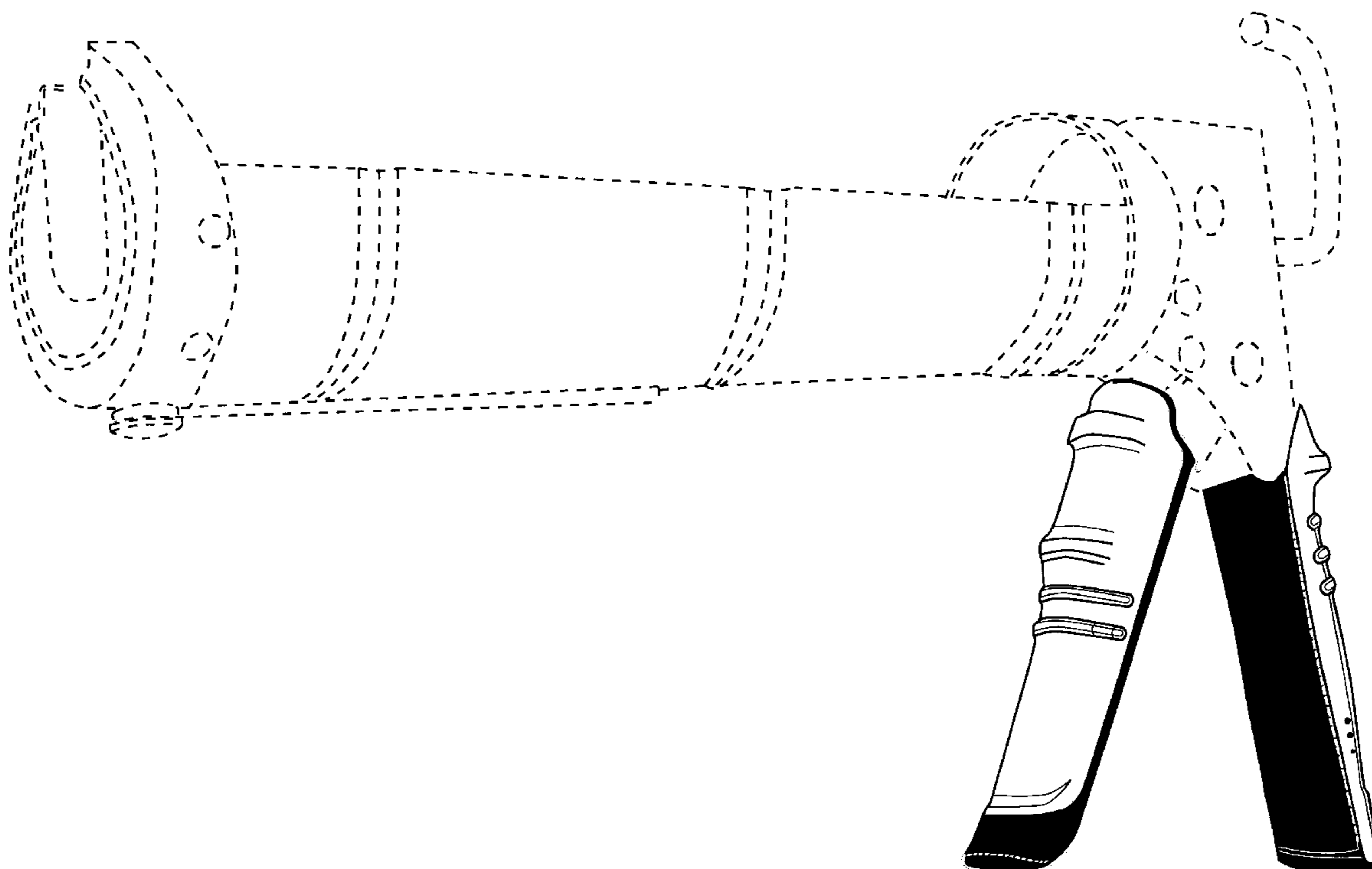

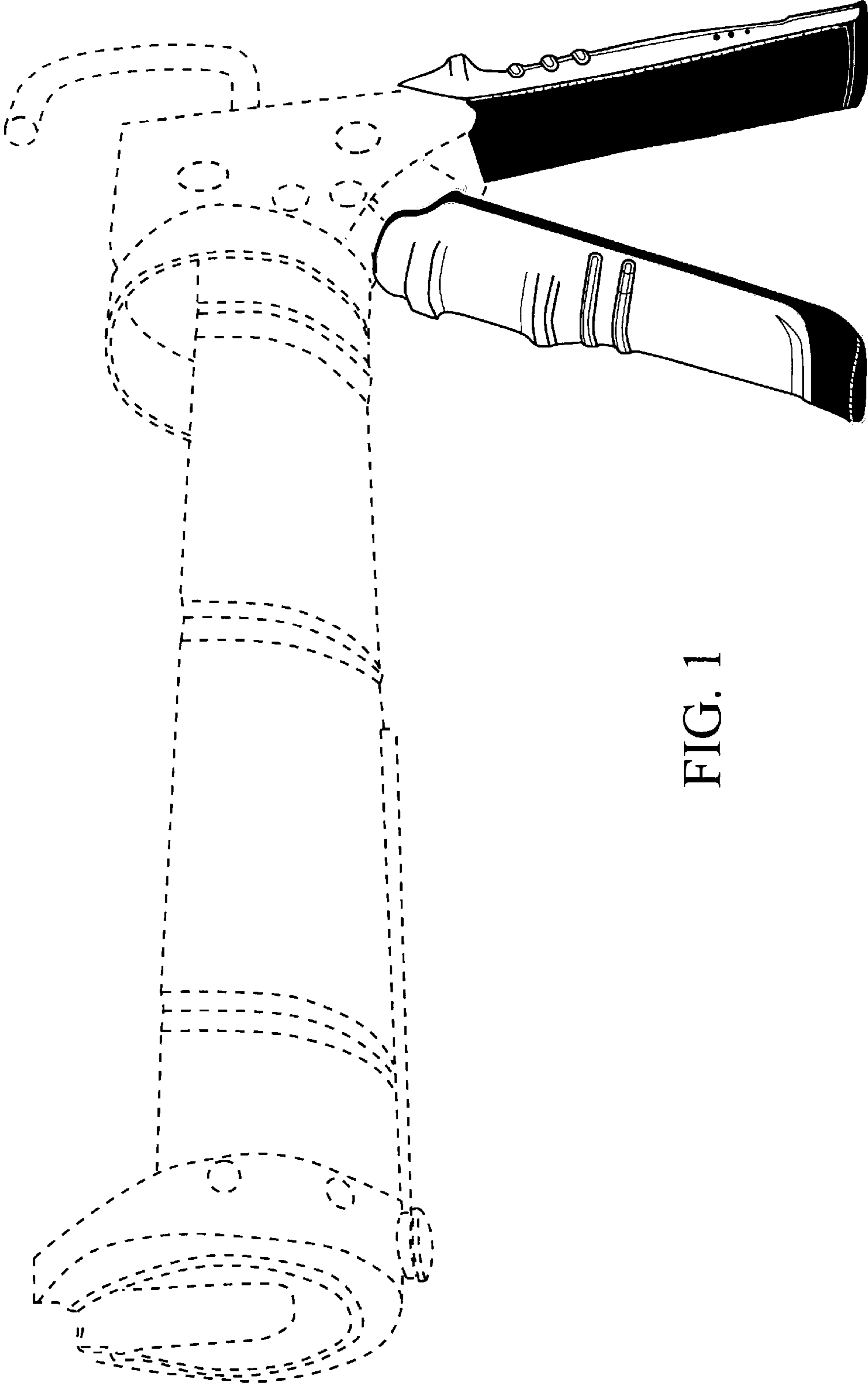

FIG. 1

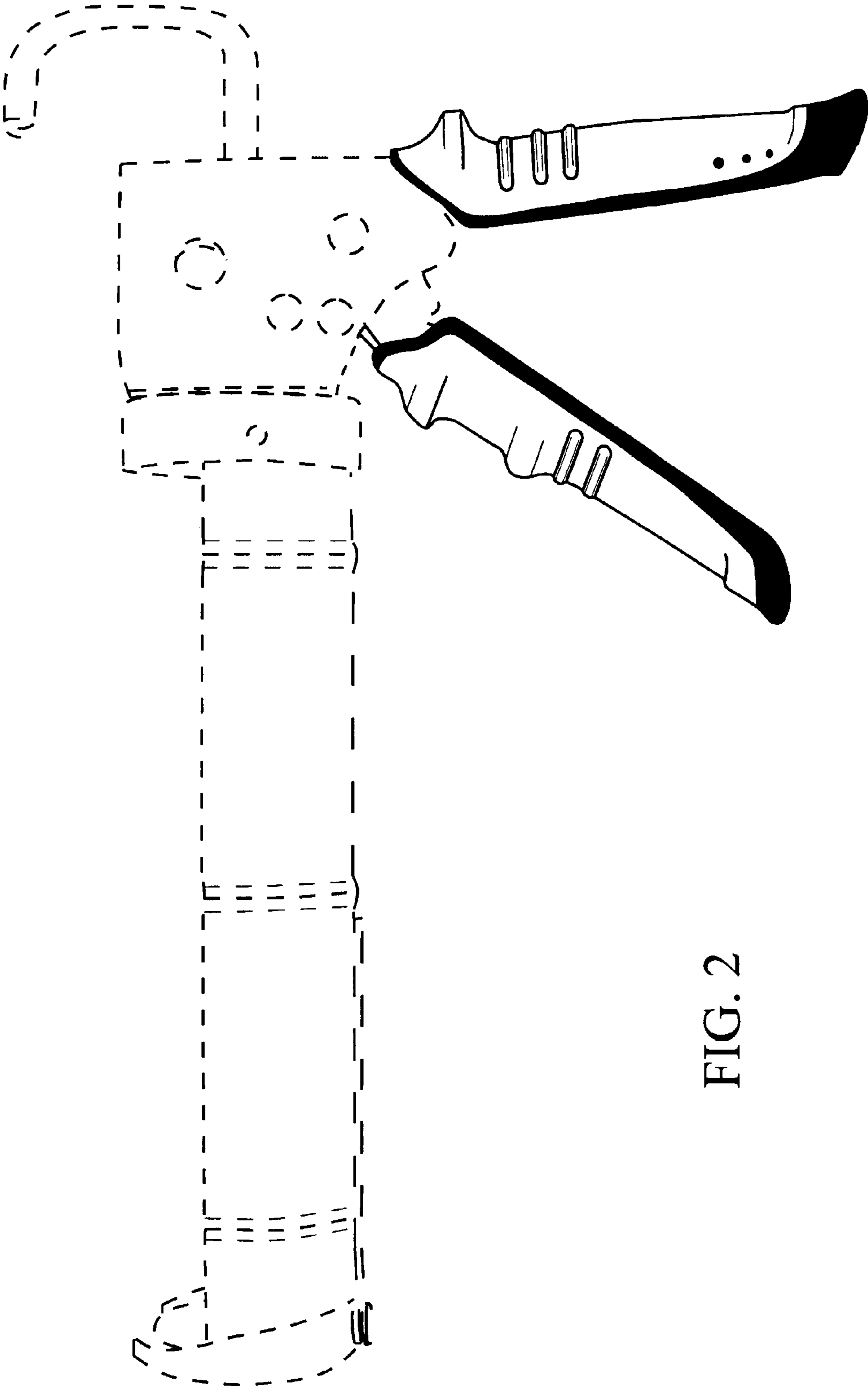

FIG. 2

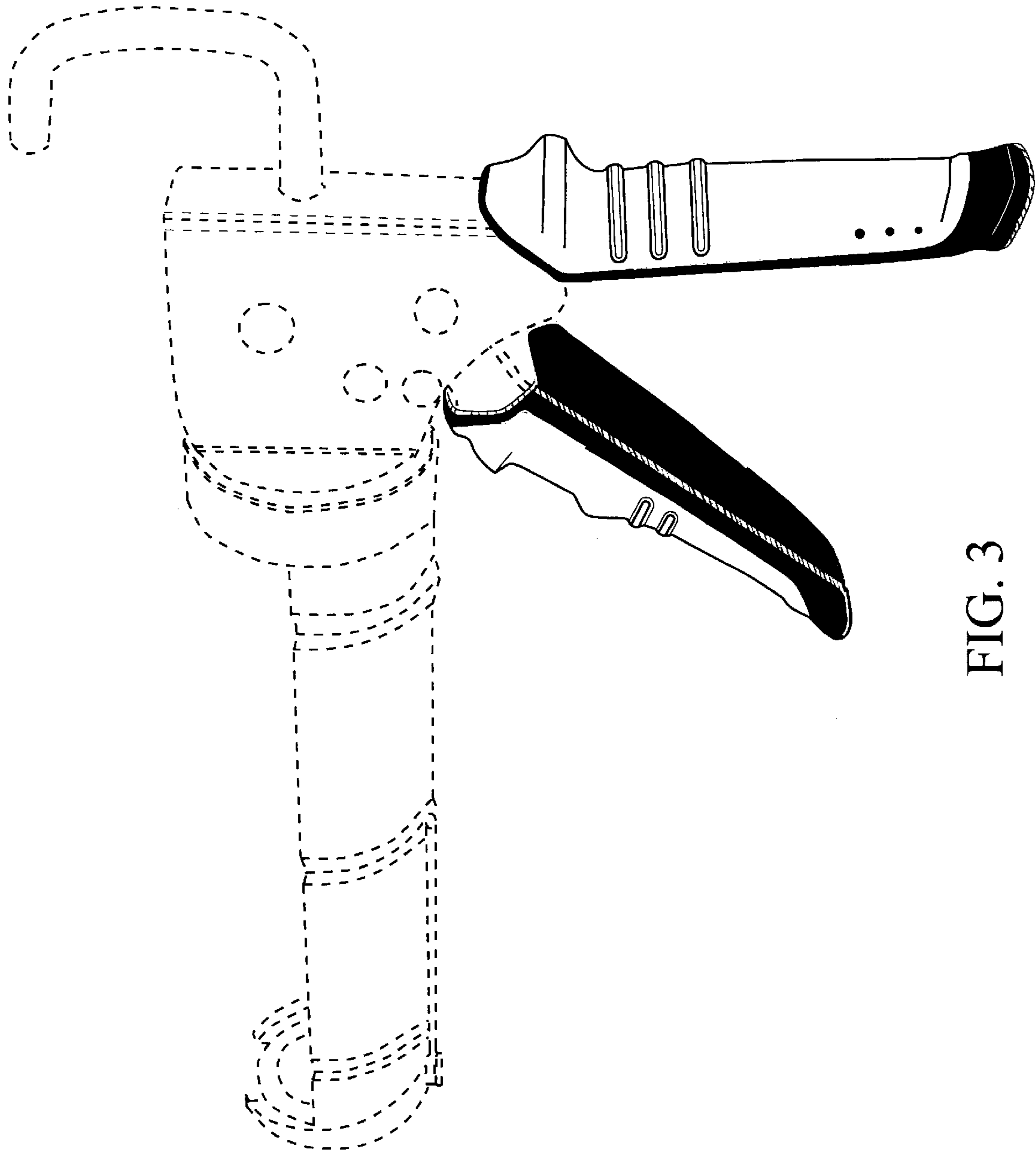

FIG. 3

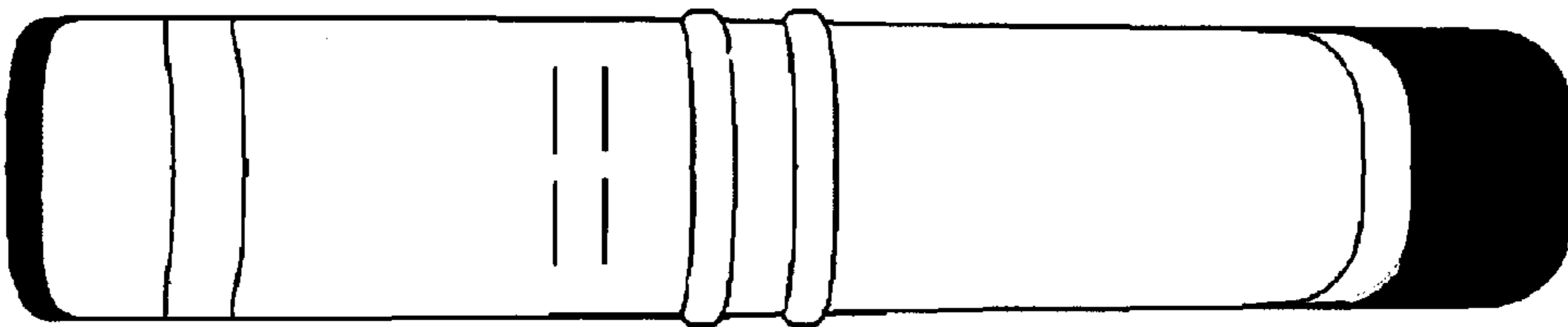

FIG. 4

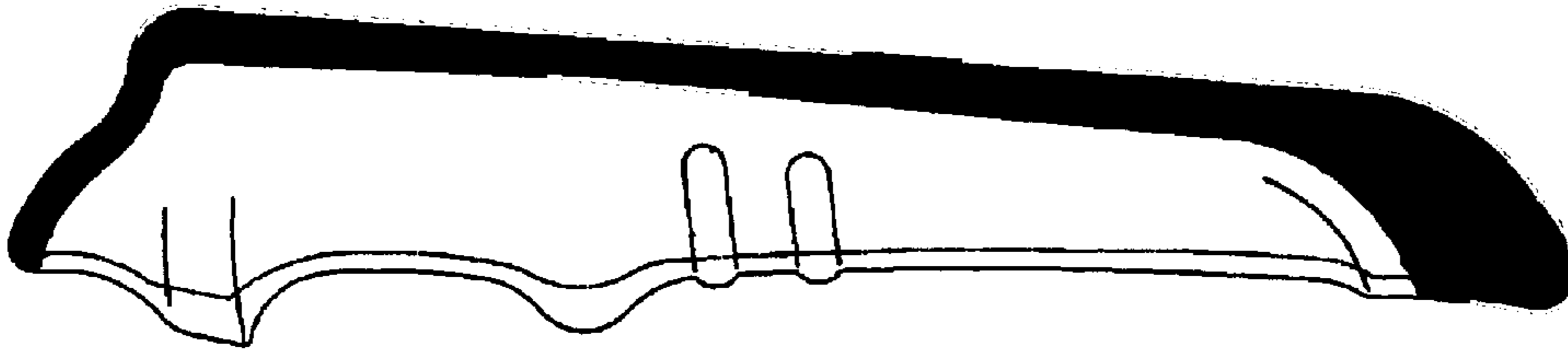

FIG. 5

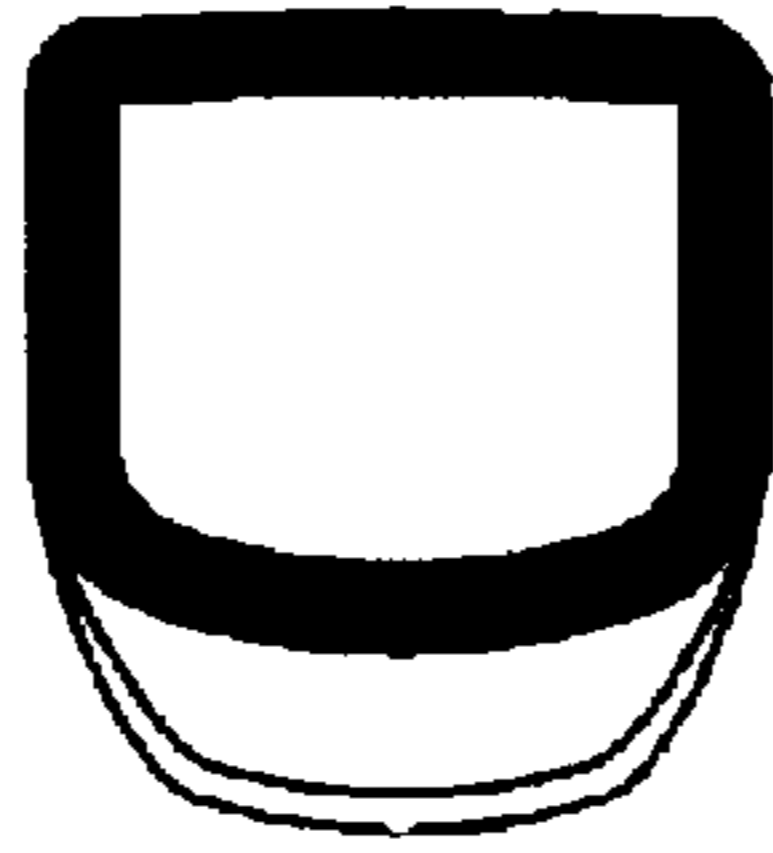

FIG. 6

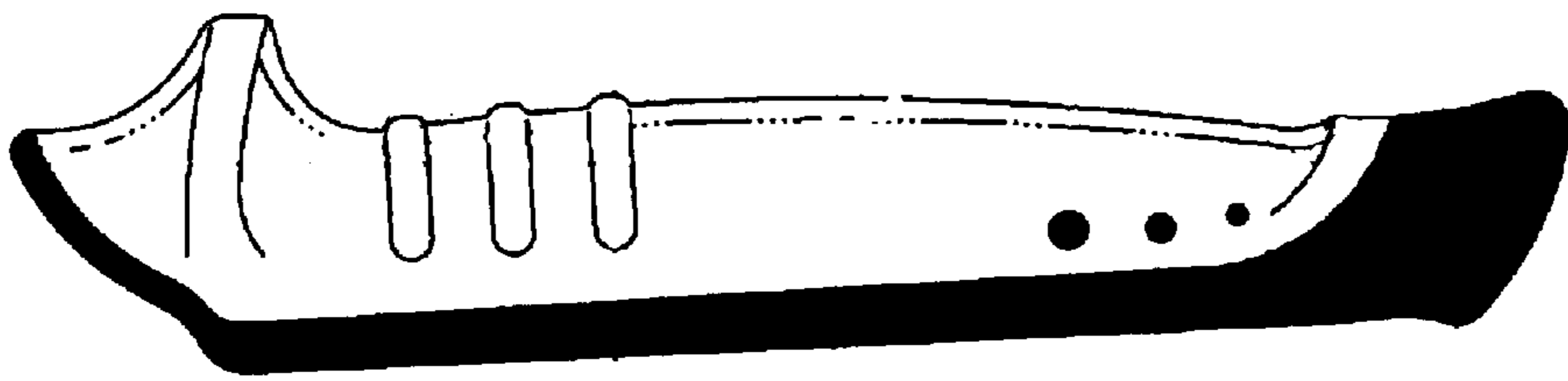

FIG. 7

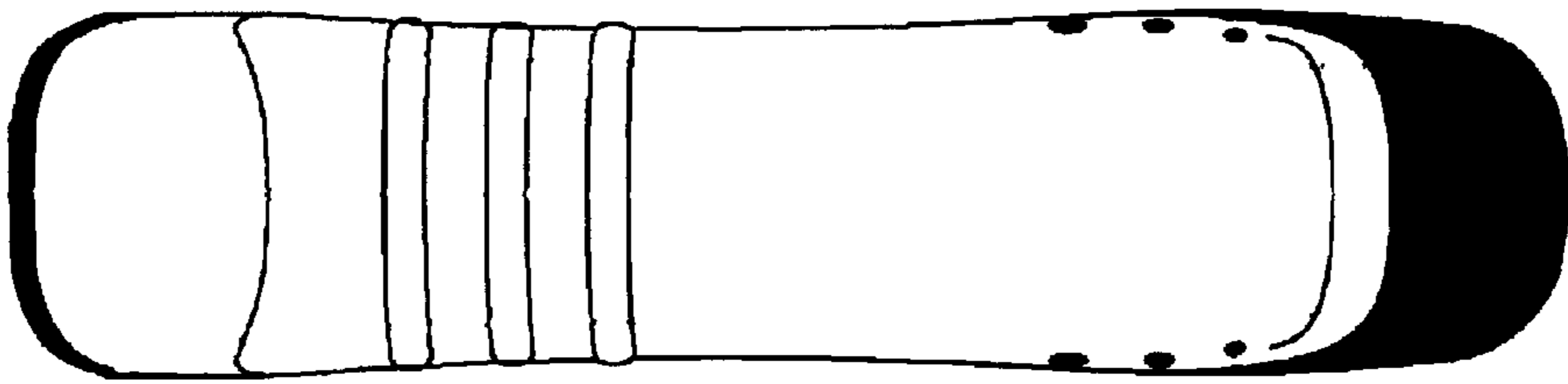

FIG. 8

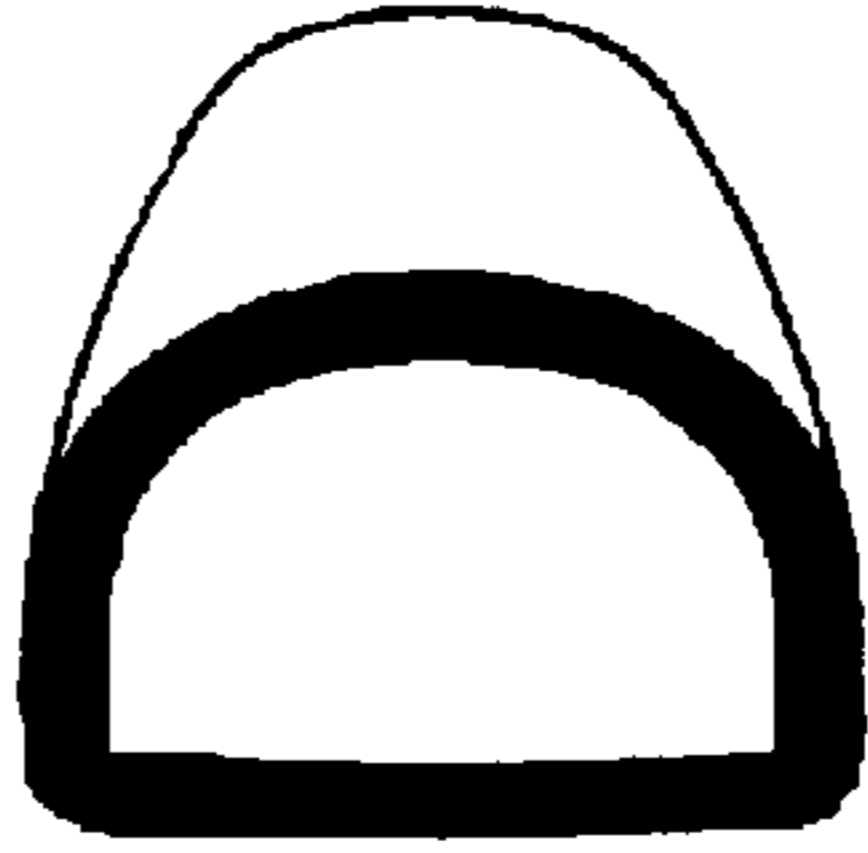

FIG. 9