



US00D520782S

(12) **United States Design Patent** (10) **Patent No.:** **US D520,782 S**  
**Glass et al.** (45) **Date of Patent:** **\*\* May 16, 2006**

(54) **CHAIR BACK**

(75) Inventors: **Peter Glass**, Arroyo Grande, CA (US);  
**Robert J. Mills**, Torrance, CA (US);  
**Jamie Toland**, Russellville, AR (US)

(73) Assignee: **Virco Mgmt. Corporation**, Torrance,  
CA (US)

(\*\*) Term: **14 Years**

(21) Appl. No.: **29/230,849**

(22) Filed: **May 27, 2005**

(51) **LOC (8) Cl.** ..... **06-06**

(52) **U.S. Cl.** ..... **D6/502**

(58) **Field of Classification Search** ..... D6/334-336,  
D6/338, 360, 365, 366, 371-373, 341, 374,  
D6/375, 376, 379, 380, 500-502; 297/296,  
297/445.1, 446.1, 447.1, 447.2, 451.1, 452.2,  
297/452.29, 239

See application file for complete search history.

(56) **References Cited**

**U.S. PATENT DOCUMENTS**

D122,005 S	8/1940	Schreckengost	
D127,281 S	2/1941	Schreckengost	
D144,991 S	* 6/1946	Spence	D6/380
D149,162 S	4/1948	Bond	
D150,683 S	* 8/1948	Eames	D6/374
D150,685 S	* 8/1948	Eames	D6/374
D155,272 S	* 9/1949	Eames	D6/374
D155,273 S	* 9/1949	Eames	D6/363
D155,274 S	* 9/1949	Eames	D6/374
D171,116 S	* 12/1953	Adkinson	D6/374
D186,103 S	* 9/1959	Junkune	D6/365
D189,347 S	11/1960	Chapman	
D195,620 S	* 7/1963	Chapman et al.	D6/374
D197,644 S	3/1964	Sudberg et al.	
3,669,496 A	6/1972	Chisholm	

(Continued)

**OTHER PUBLICATIONS**

Virco "Furniture Solutions" 2003 General Catalog, pp. 6, 9,  
52, 56, 57, 58, 59, 62, 66, 69, and last page, 2027 Harpers  
Way, Torrance, CA 90501.

American Desk, "Classroom Furniture," Catalog, pp. 6, 18,  
and end page, P.O. Box 6107, Temple TX 76403.

Artco-Bell Corporation, "Furniture to Enhance Education,"  
Catalog, pp. 12 and 13, Culver-Newlin, Inc., 840 Wanama-  
ker Ave., Ontario CA 91761.

Artco-Bell Corporation, "Product Library 2001," Catalog,  
pp. 6, 7, 8, and end page, P.O. Box 608, 1302 Industrial  
Blvd., Temple, TX 76403.

Capital Seating Company, "Premium Quality Classroom  
Furniture," Catalog, 3 pages.

CDF, "School Furniture," Catalog, 1 page.

Columbia, "Alpha Chairs," One Cycle Street, Westfield, MA  
01086.

Ivy League School Furniture, Catalog, 1 page.

National School Lines, "Classroom Furniture," Catalog, pp.  
7 and 8, Oshkosh, WI, www.nsi-inc.com.

Royal Seating Corporation, "Educational and Computer  
Furniture," Catalog, pp. 6, 8, 20, and 24.

Scholarcraft, "School Furniture," Catalog, pp. 3, 5, 9, and  
end page, P.O. Box 170748, Birmingham, AL, 35217  
(2001).

*Primary Examiner*—Mimosa De

(74) *Attorney, Agent, or Firm*—Robert M. Hupe; Virco  
Mgmt. Corporation

(57) **CLAIM**

The ornamental design for a "chair back," as shown and  
described.

**DESCRIPTION**

FIG. 1 is a front perspective view of a chair back showing  
my new design;

FIG. 2 is a bottom view thereof;

FIG. 3 is a back view thereof;

FIG. 4 is a left side view, the opposite side view being a  
mirror image, thereof;

FIG. 5 a front view thereof;

FIG. 6 is a top view thereof; and,

FIG. 7 is a back perspective view thereof.

**1 Claim, 2 Drawing Sheets**

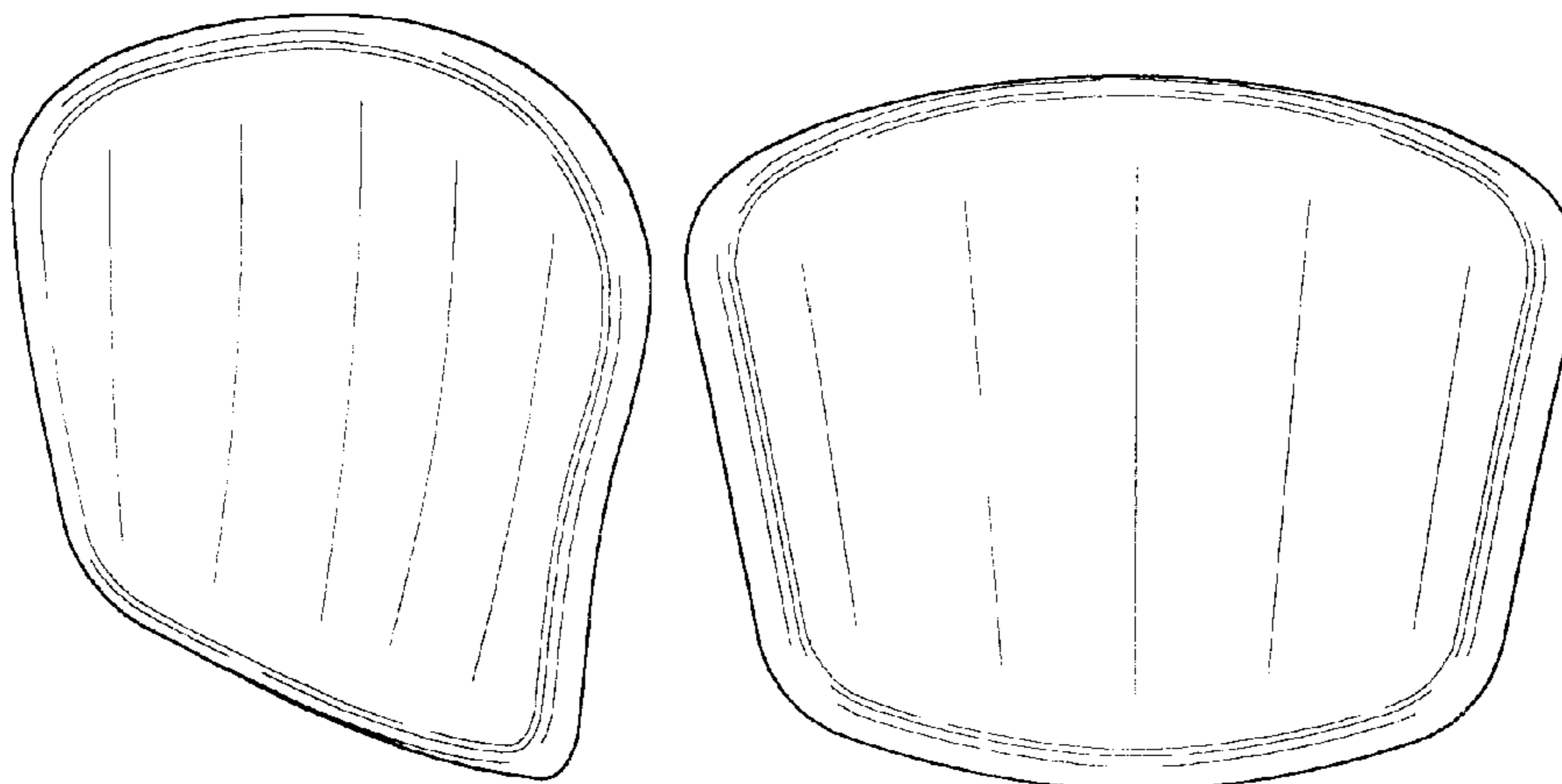

# US D520,782 S

Page 2

---

## U.S. PATENT DOCUMENTS

4,002,369	A	1/1977	Jennings				
D252,904	S	9/1979	Springfield				
D279,443	S	* 7/1985	Diffrient	.....	D6/501		
5,154,474	A	* 10/1992	Desanta	.....	297/239		
D336,805	S	* 6/1993	Starke	.....	D6/502		
D383,009	S	* 9/1997	Piretti	.....	D6/372		
D395,765	S	* 7/1998	Preisig	.....	D6/372		
D409,407	S	5/1999	Wang				
D417,570	S	* 12/1999	Baumann et al.	.....	D6/502		
D438,734	S	* 3/2001	Turner et al.	.....	D6/502		
D439,070	S	* 3/2001	Turner et al.	.....	D6/380		
D463,178	S	* 9/2002	Chu	.....	D6/502		
D469,969	S	2/2003	Glass et al.				
D470,320	S	2/2003	Schloss				
D471,730	S	3/2003	Schloss				
D473,407	S	4/2003	Ross				
D492,147	S	6/2004	Mizelle				
D499,260	S	12/2004	Glass et al.				

\* cited by examiner

*FIG. 1*

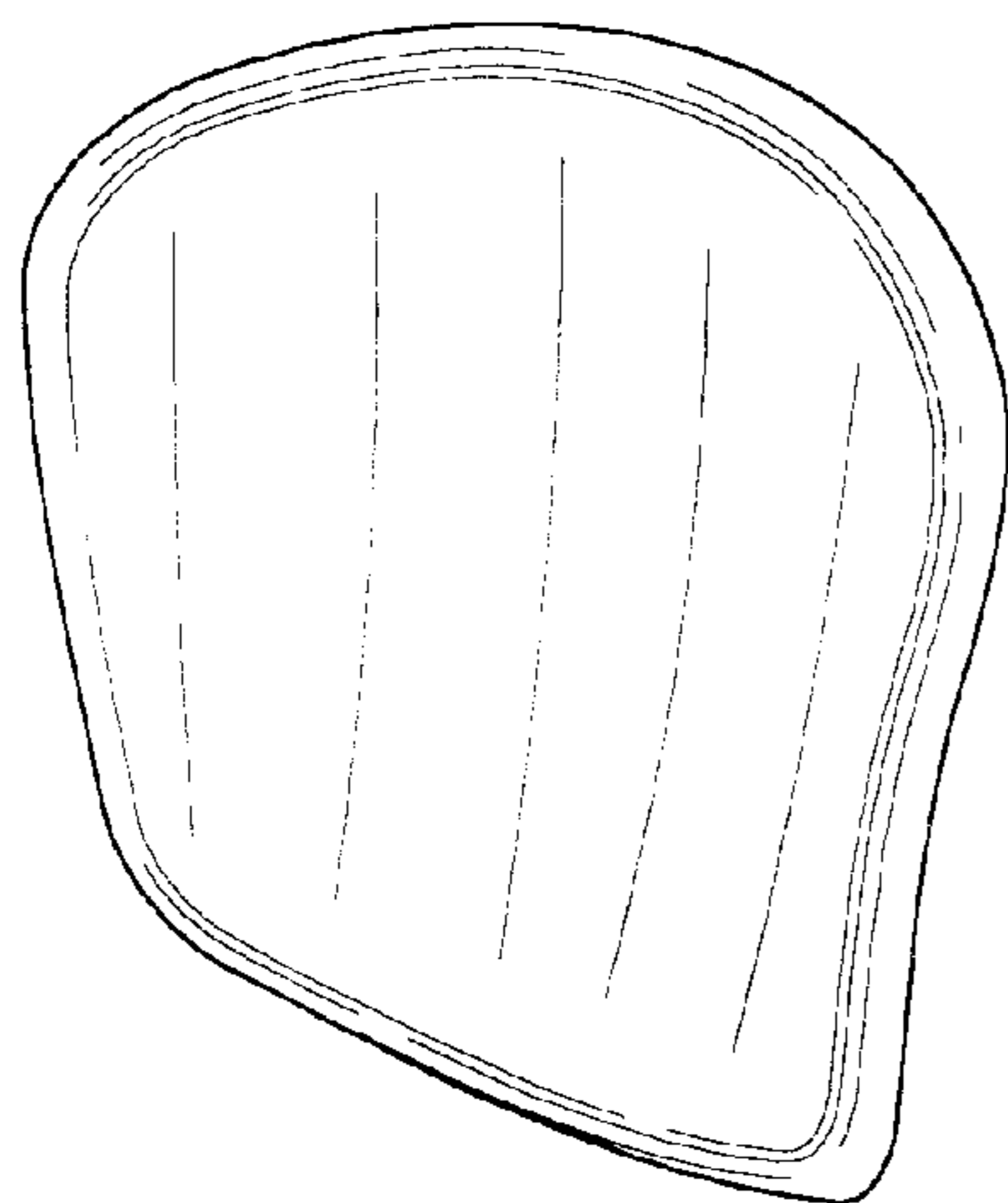

*FIG. 2*

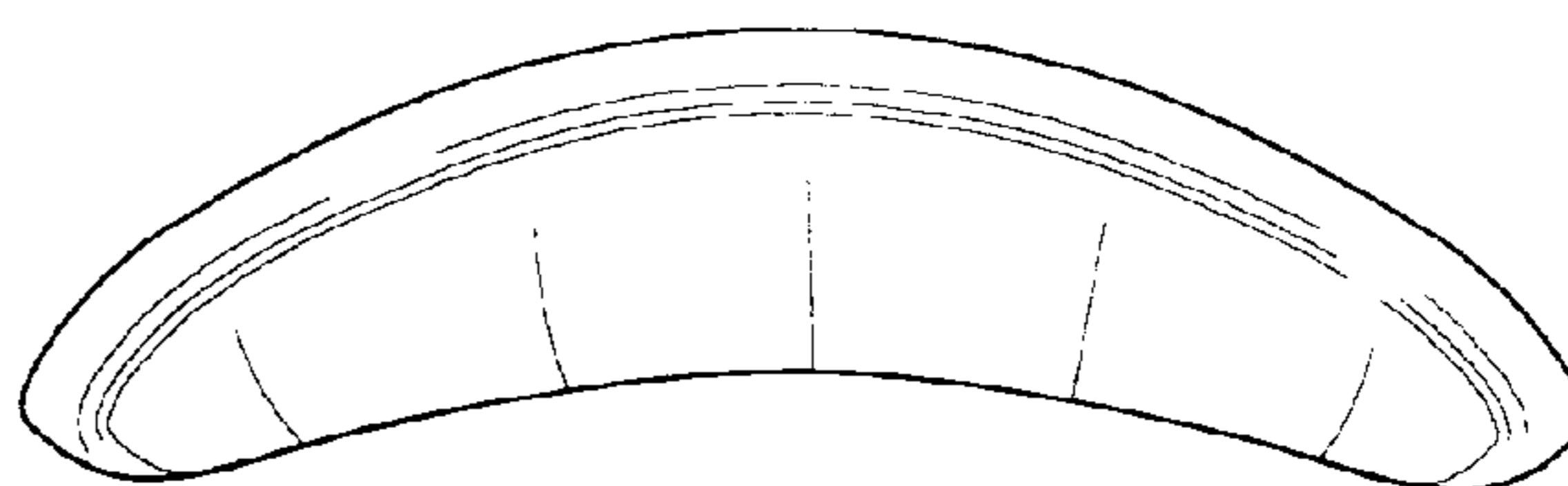

*FIG. 3*

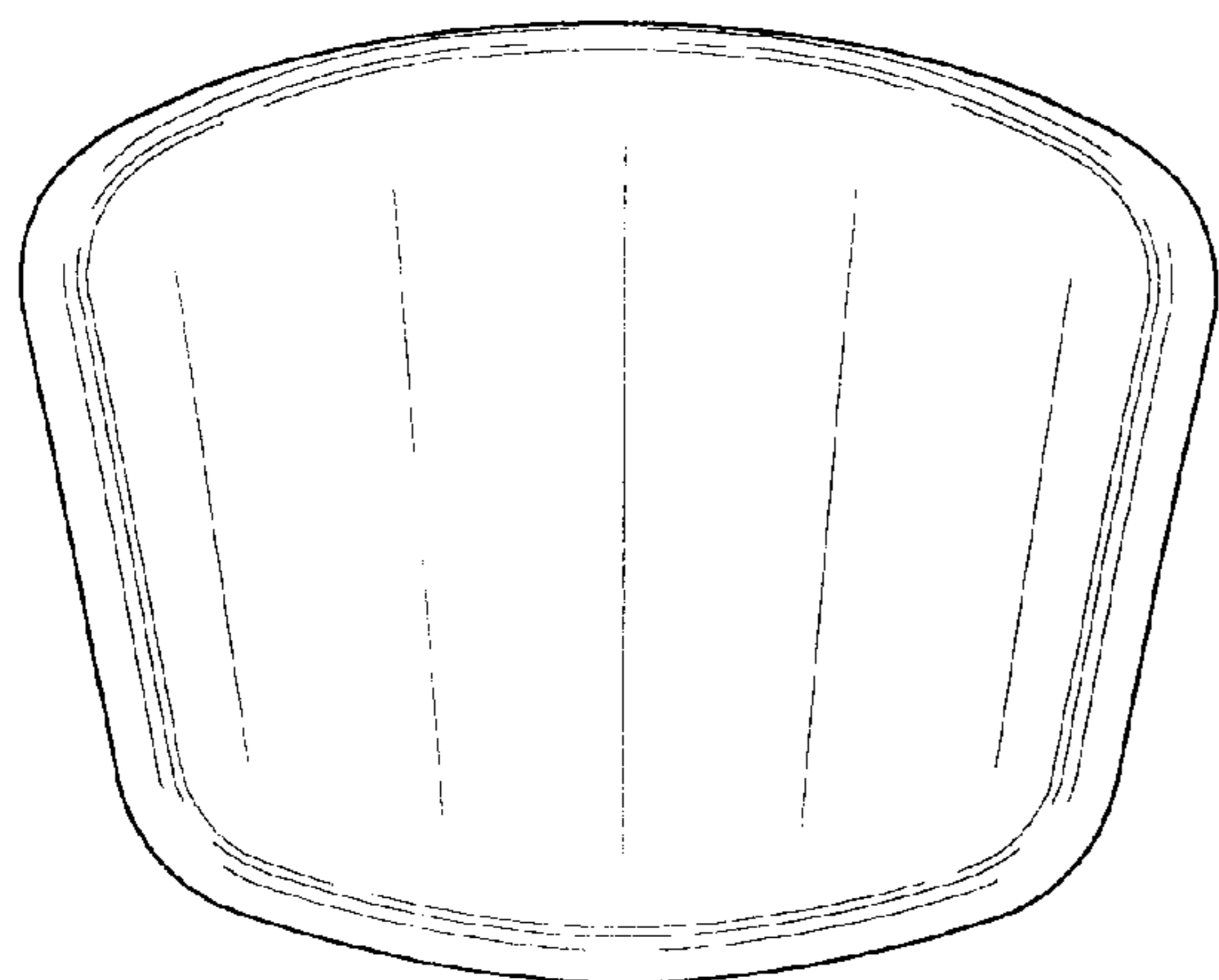

*FIG. 4*

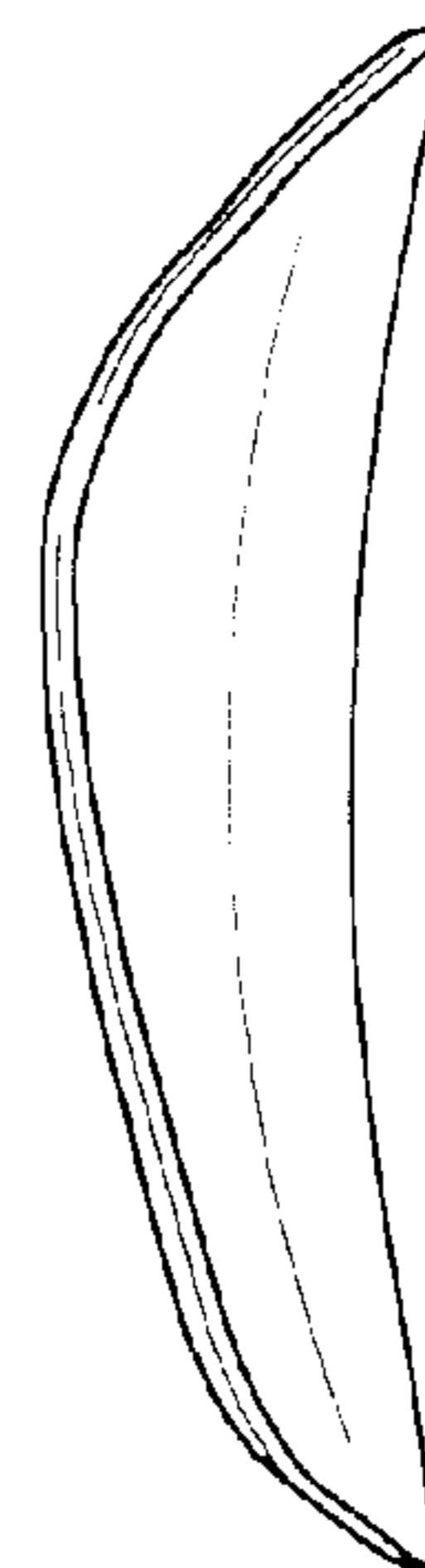

*FIG. 5*

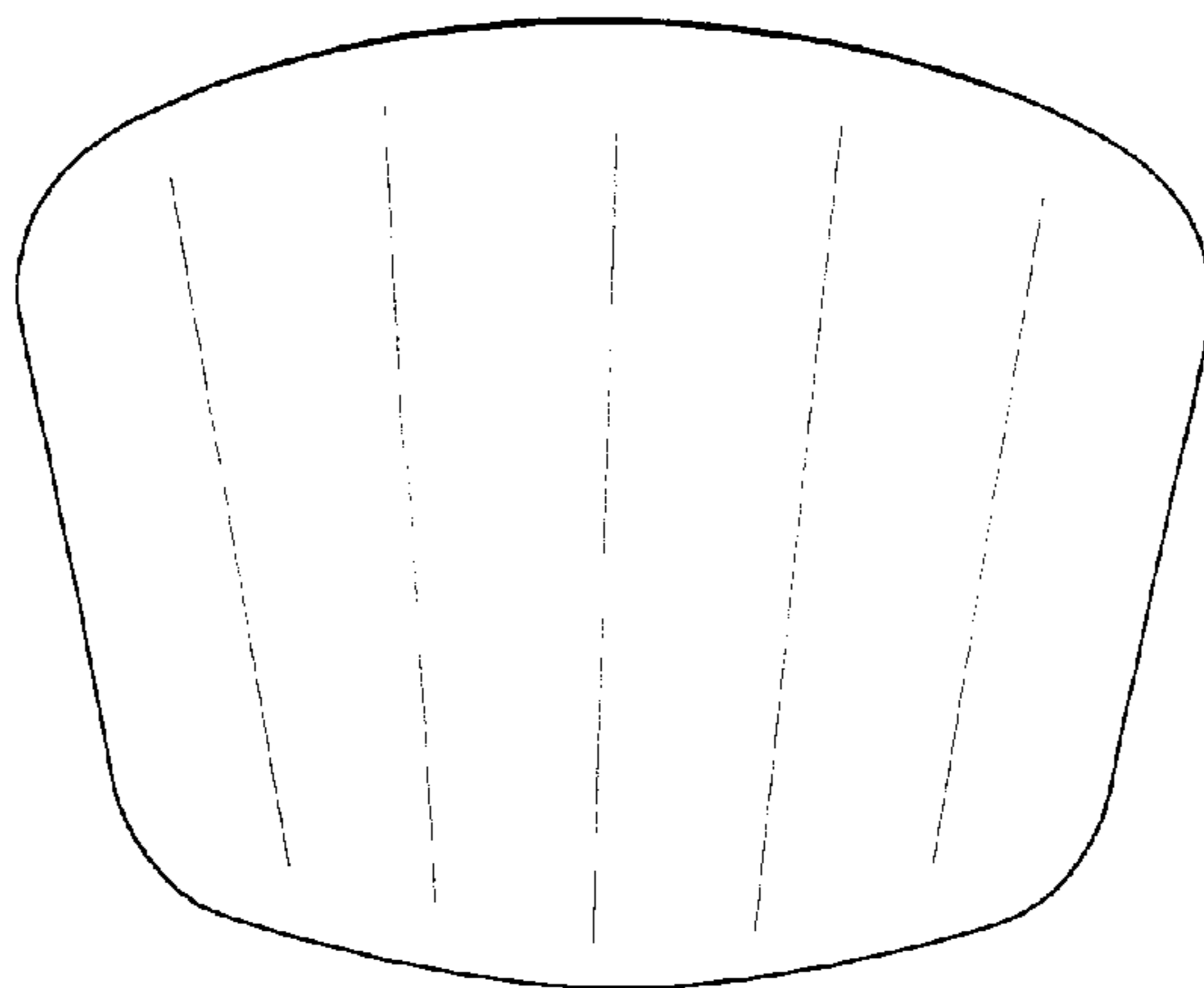

*FIG. 6*

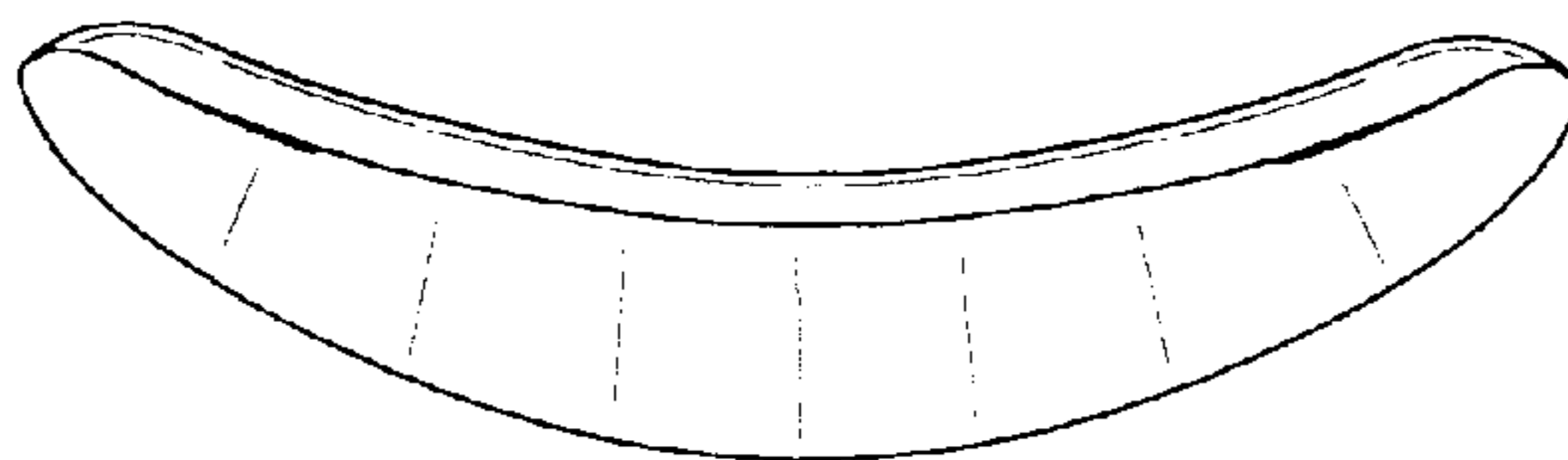

*FIG. 7*

