



US00D520744S

(12) **United States Design Patent** (10) **Patent No.:** **US D520,744 S**
Pangerc et al. (45) **Date of Patent:** **** May 16, 2006**

(54) **STORAGE CONTAINER**
 (75) Inventors: **James E. Pangerc**, Parkville, MD
 (US); **David L. Wikle**, York, PA (US)
 (73) Assignee: **Black & Decker Inc.**, Newark, DE
 (US)
 (**) Term: **14 Years**

DE	G8514919.5	8/1985
DE	3837829 C1	10/1989
DE	G9310875.3	6/1994
DE	29618465 U1	2/1997
DE	19612149 C1	7/1997
DE	29710394 U1	9/1997
DE	19611301 C2	10/1999
DE	29913188 U1	12/1999
DE	20119665	3/2002
EP	0199080 B1	3/1986

(21) Appl. No.: **29/199,721**
 (22) Filed: **Feb. 18, 2004**

Primary Examiner—Philip S. Hyder
 (74) *Attorney, Agent, or Firm*—Harness, Dickey & Pierce,
 P.L.C.

(51) **LOC (8) Cl.** **03-01**
 (52) **U.S. Cl.** **D3/273; D3/294; D3/905**
 (58) **Field of Classification Search** **D3/273,**
D3/276, 282, 294, 295, 905; 206/349, 372,
206/373; 312/902

(57) **CLAIM**

The ornamental design for a storage container, as shown and described.

See application file for complete search history.

DESCRIPTION

(56) **References Cited**

U.S. PATENT DOCUMENTS

1,013,576	A	1/1912	Wermerskirchen
RE13,408	E	4/1912	Sine
2,403,825	A	7/1946	Nissenbaum
2,564,601	A	8/1951	Huot
2,568,089	A	9/1951	Pendleton
2,589,234	A	3/1952	Drohman
3,018,876	A	1/1962	Huot
3,074,539	A	1/1963	Rogovin
4,006,821	A	2/1977	Sautter

FIG. 1 is a front right perspective view of a storage container;
 FIG. 2 is a front left perspective view thereof;
 FIG. 3 is a front planar view thereof;
 FIG. 4 is a rear planar view thereof;
 FIG. 5 is a top view thereof;
 FIG. 6 is a bottom view thereof;
 FIG. 7 is a right side view thereof;
 FIG. 8 is a left side view thereof;
 FIG. 9 is a front right perspective view of a second embodiment of a storage container;
 FIG. 10 is a front left perspective view thereof;
 FIG. 11 is a rear planar view thereof;
 FIG. 12 is a front planar view thereof;
 FIG. 13 is a top view thereof;
 FIG. 14 is a bottom view thereof;
 FIG. 15 is a right side view thereof; and,
 FIG. 16 is a left side view thereof.

(Continued)

FOREIGN PATENT DOCUMENTS

DE	1037956	2/1959
DE	1059368	12/1959
DE	1895600	5/1964
DE	2008963	9/1971
DE	7721646	1/1979
DE	2461766 C3	5/1982
DE	G8304781.6	6/1983
DE	G8314923.6	9/1983
DE	215290	11/1984
DE	G8514919	8/1985

The lines shown in phantom are for illustrative purposes only and do not form part of the invention.

The broken line portions of the disclosure are is for illustrative purposes only and forms no part of the claimed design.

1 Claim, 6 Drawing Sheets

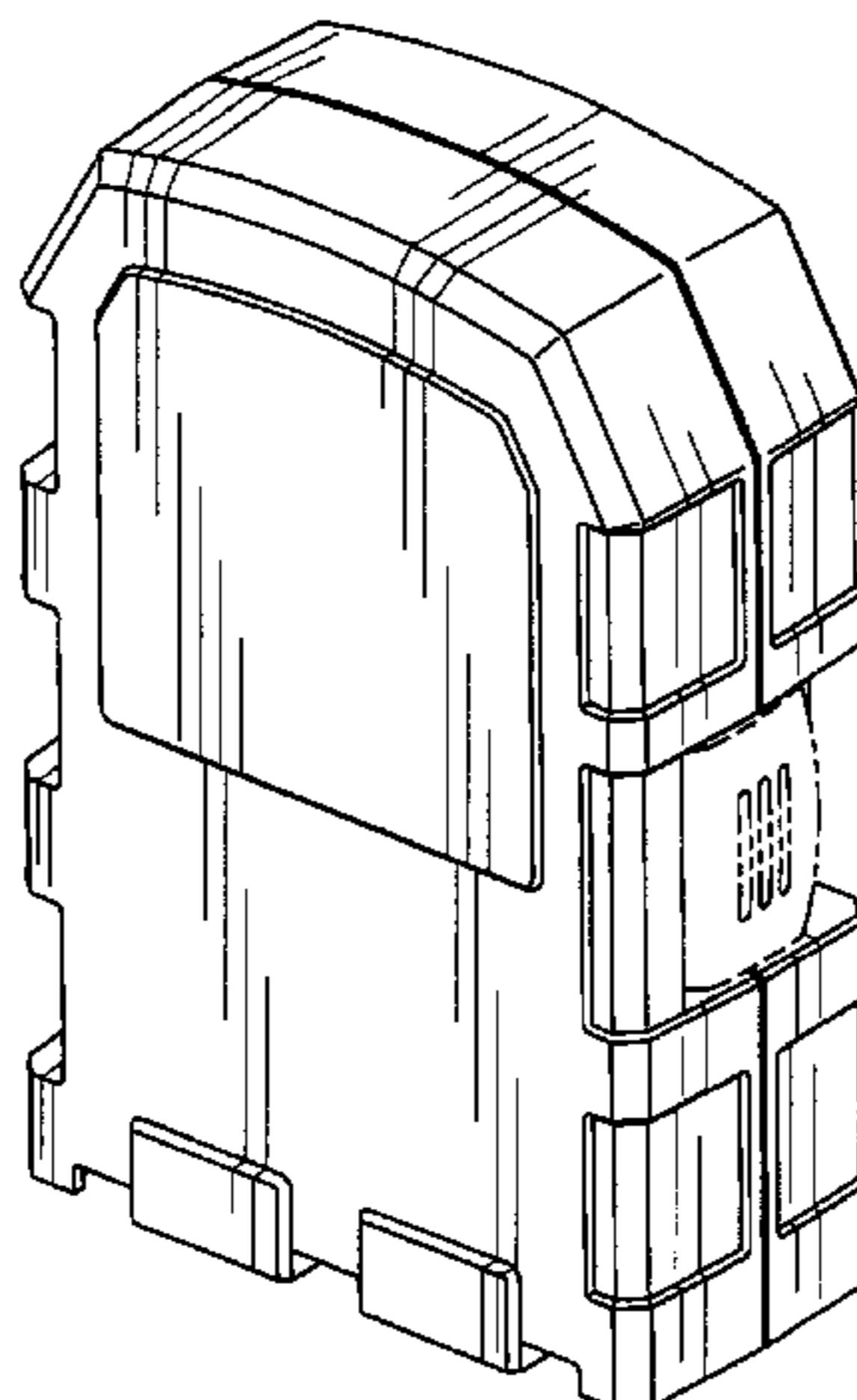

US D520,744 S

Page 2

U.S. PATENT DOCUMENTS

D266,115 S	9/1982	Glenn, Sr. et al.	
4,660,719 A	4/1987	Peterson et al.	
4,848,585 A	7/1989	Snyder	
D317,380 S	6/1991	Snyder	
5,186,339 A	2/1993	Heissler	
D334,534 S	4/1993	Friz et al.	
D345,650 S	* 4/1994	Boyd	D3/294
D374,988 S	* 10/1996	Hillinger	D3/294
D382,115 S	* 8/1997	Chang	D3/282
5,687,849 A	11/1997	Borenstein et al.	
5,746,316 A	5/1998	La Barre	
5,813,533 A	9/1998	Knoblauch	
D418,977 S	* 1/2000	Streich	D3/273
D431,359 S	10/2000	Lapidus	
D436,441 S	1/2001	Lapidus	
D437,684 S	* 2/2001	Streich et al.	D3/273
D446,018 S	8/2001	Streich et al.	
D449,931 S	* 11/2001	Snider	D3/294
6,415,922 B1	7/2002	Lee	
D467,078 S	* 12/2002	Snider	D3/294
6,508,360 B1	1/2003	Chen	
6,547,074 B1	4/2003	Chen	
6,547,077 B1	4/2003	Budert	
D477,714 S	* 7/2003	Cunningham et al.	D3/273
D478,209 S	* 8/2003	Chen	D3/282
D481,868 S	* 11/2003	Cunningham et al.	D3/273

* cited by examiner

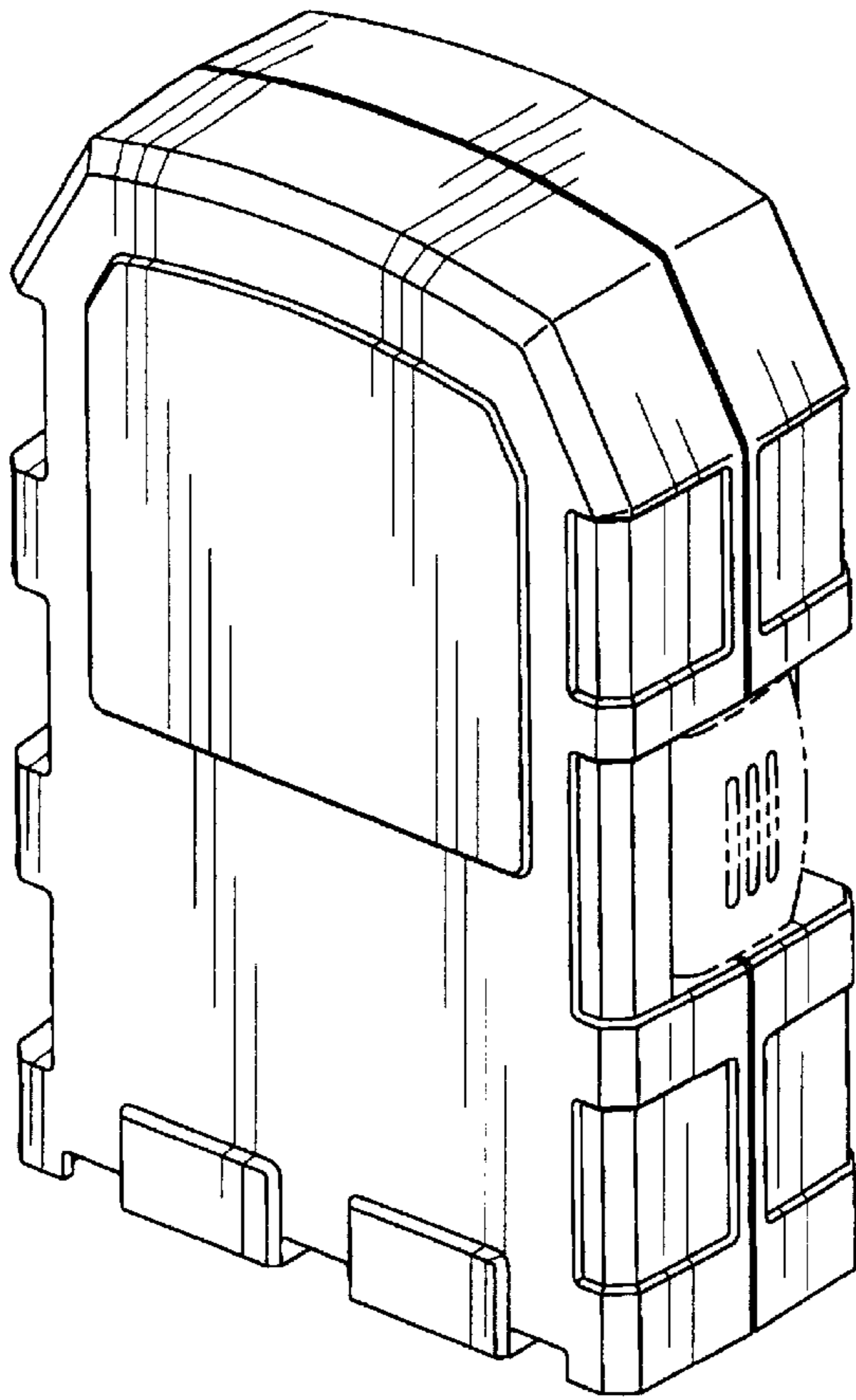

Fig-1

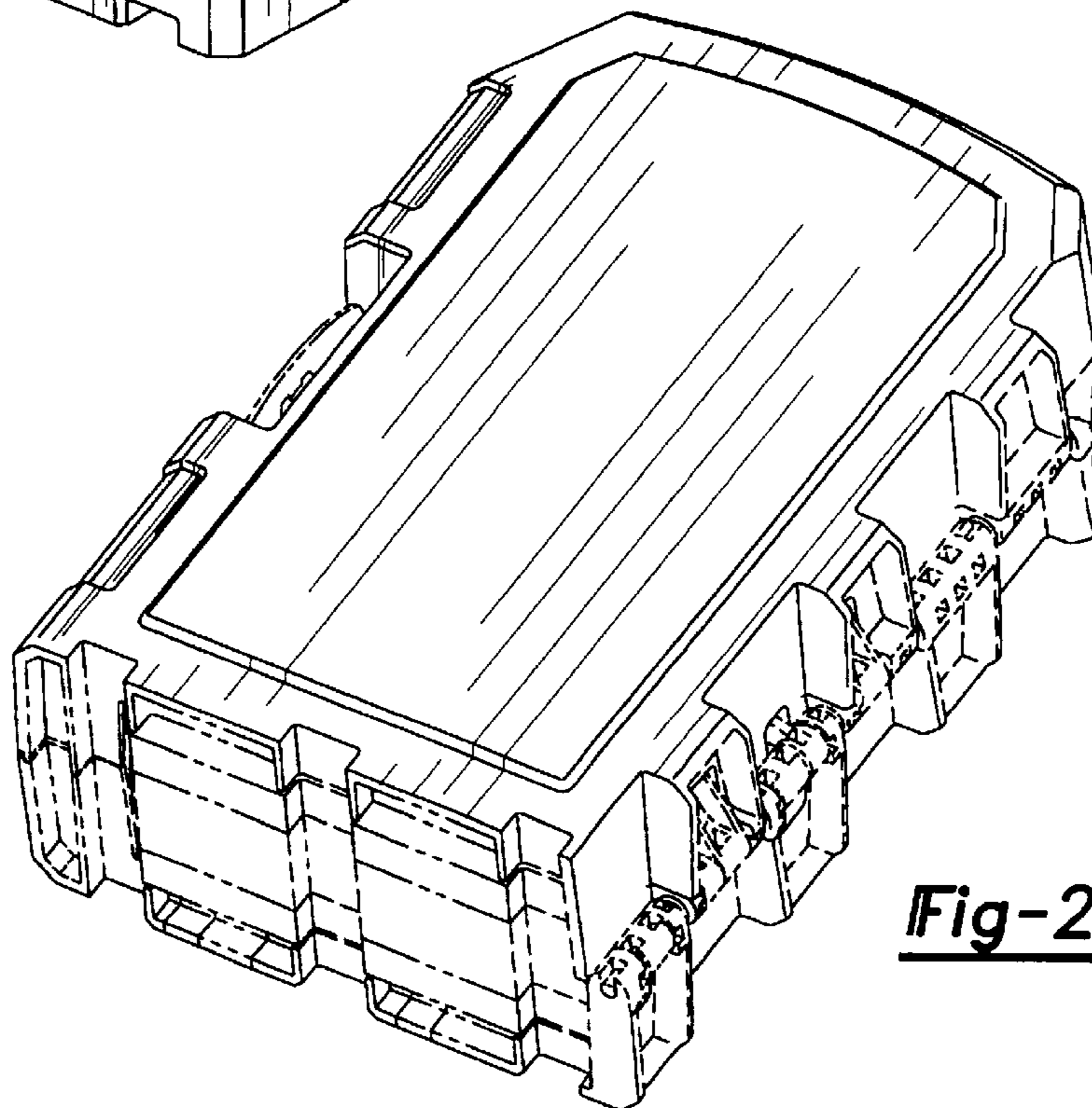

Fig-2

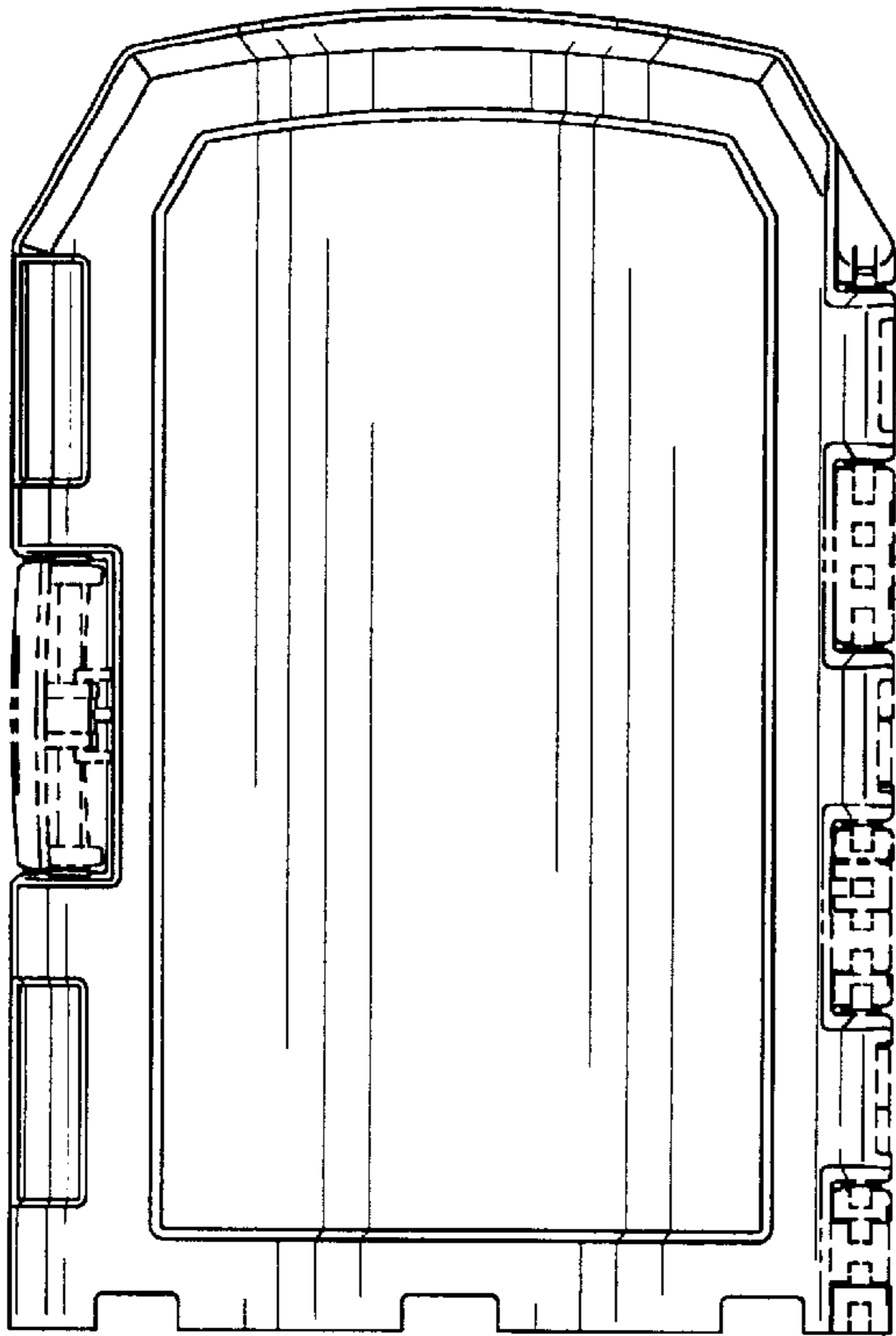

Fig-3

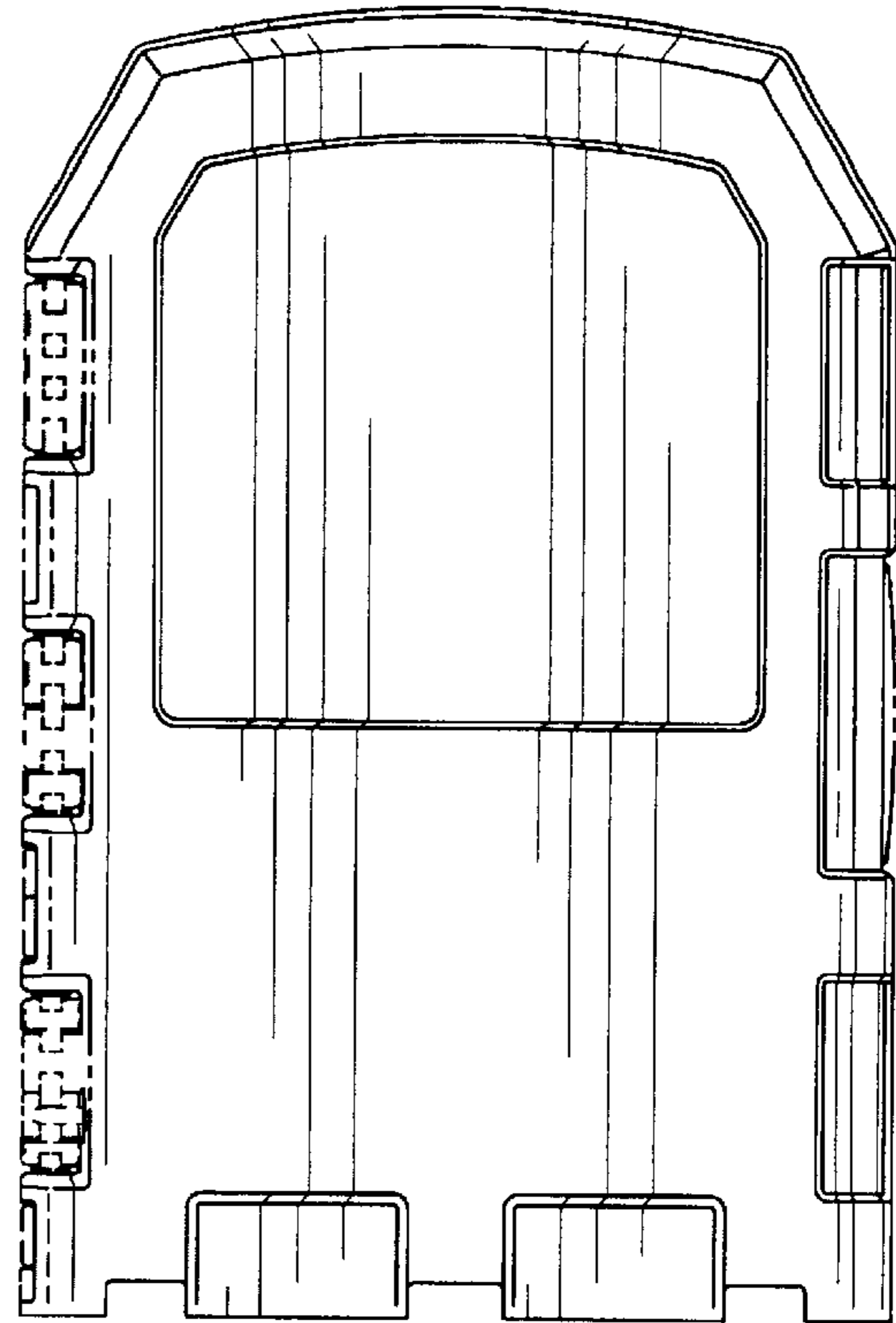

Fig-4

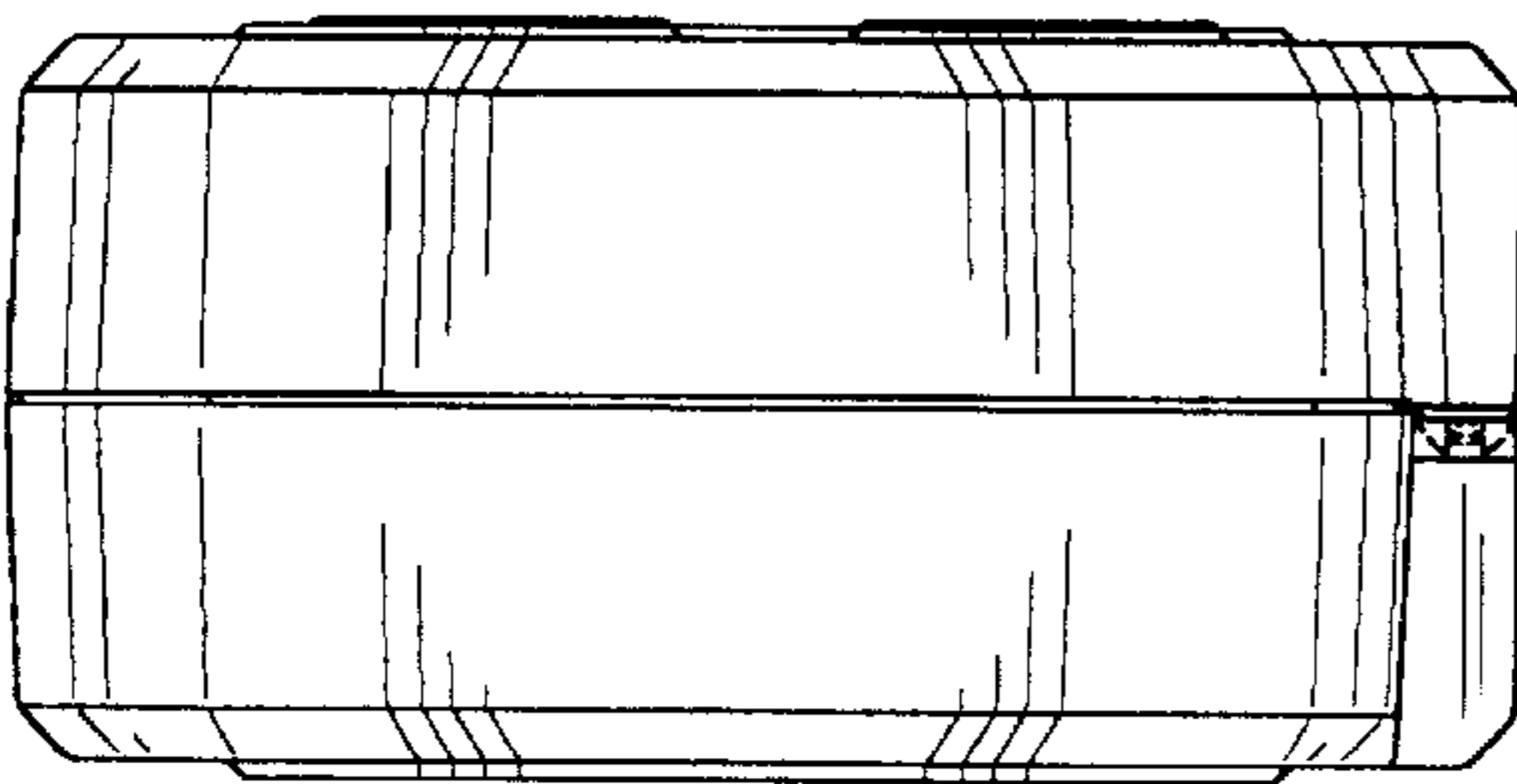

Fig-5

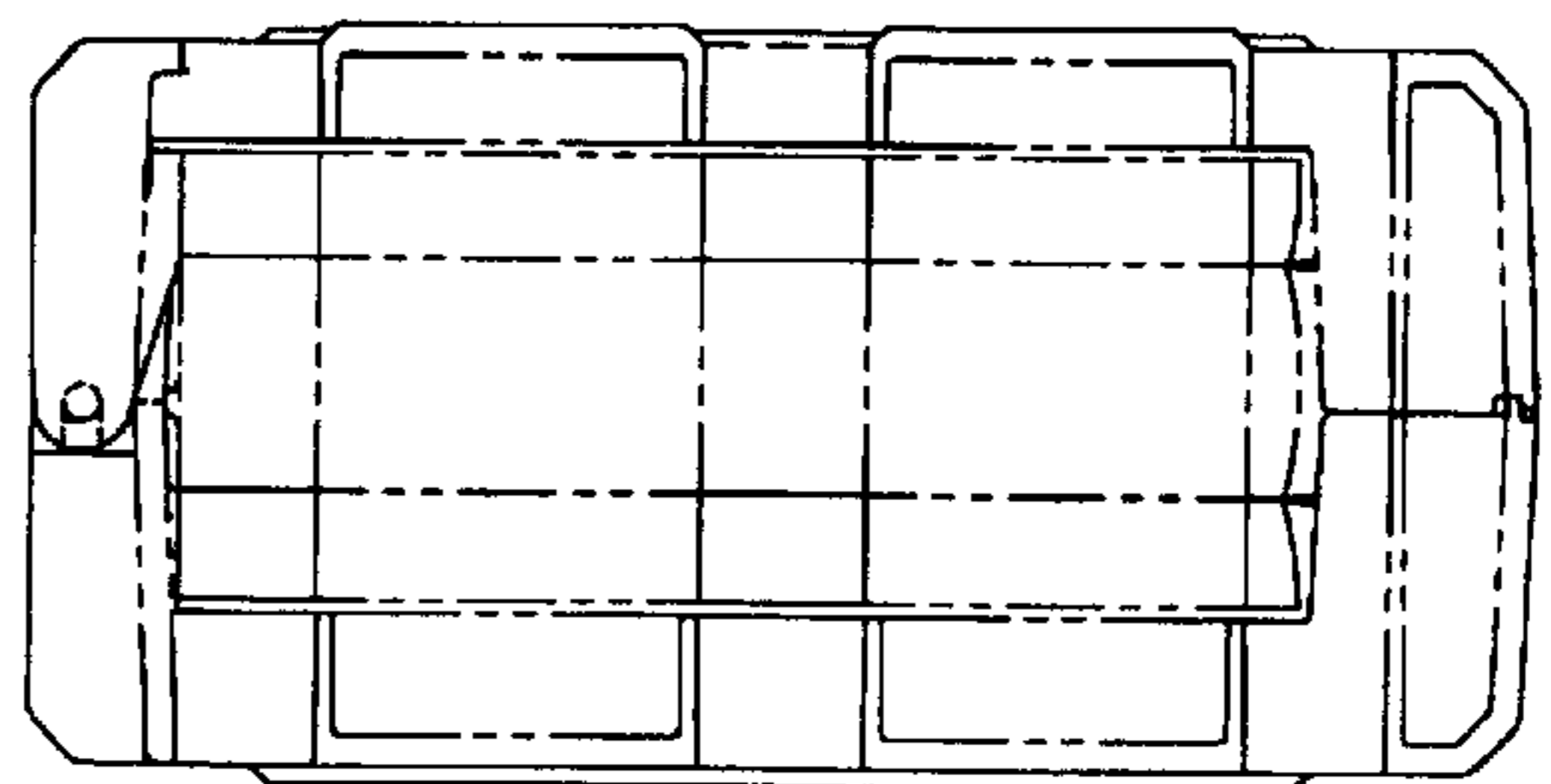

Fig-6

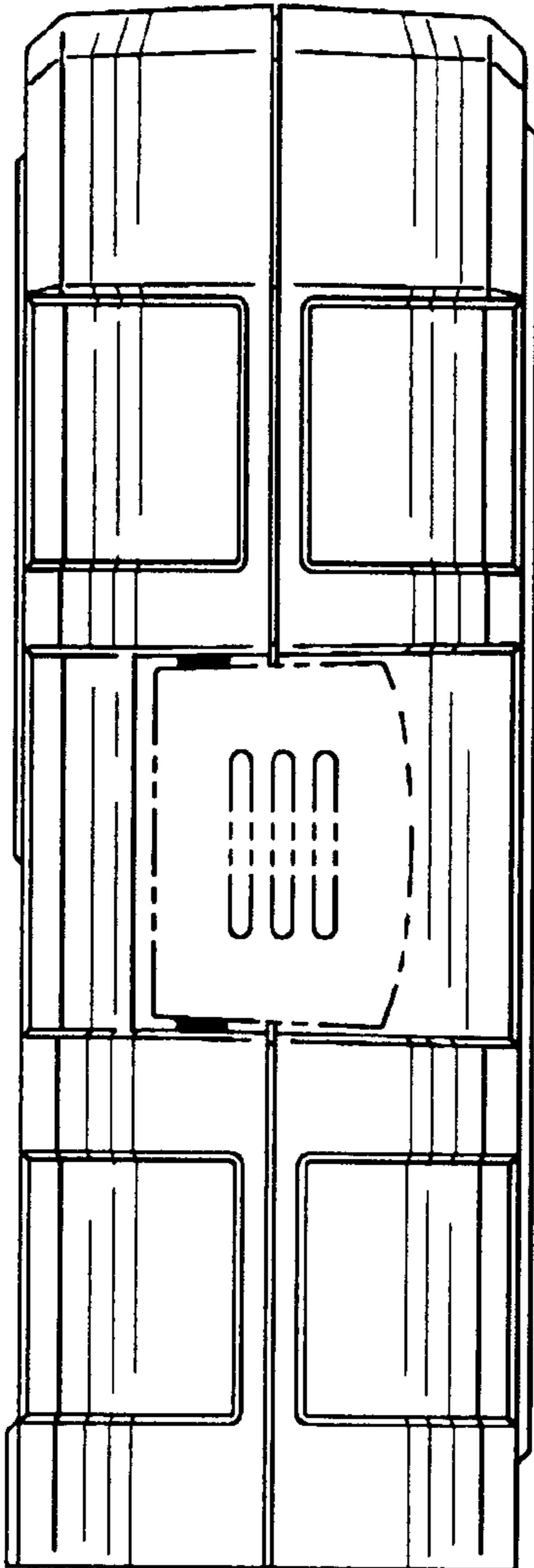

Fig-7

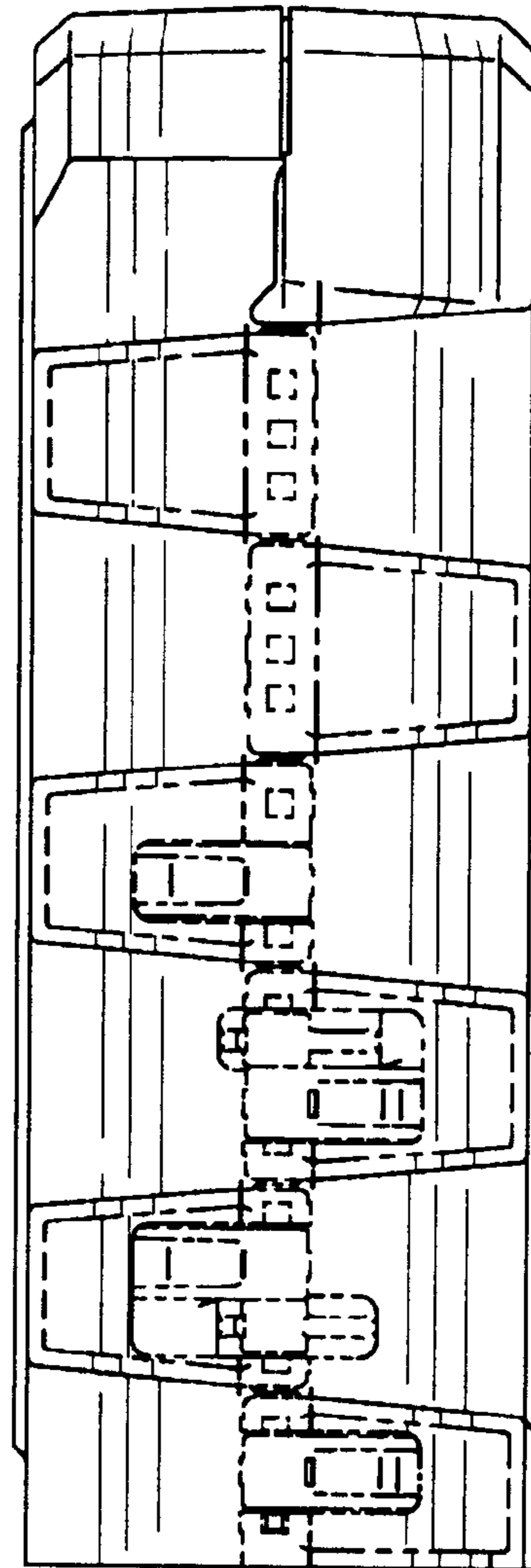

Fig-8

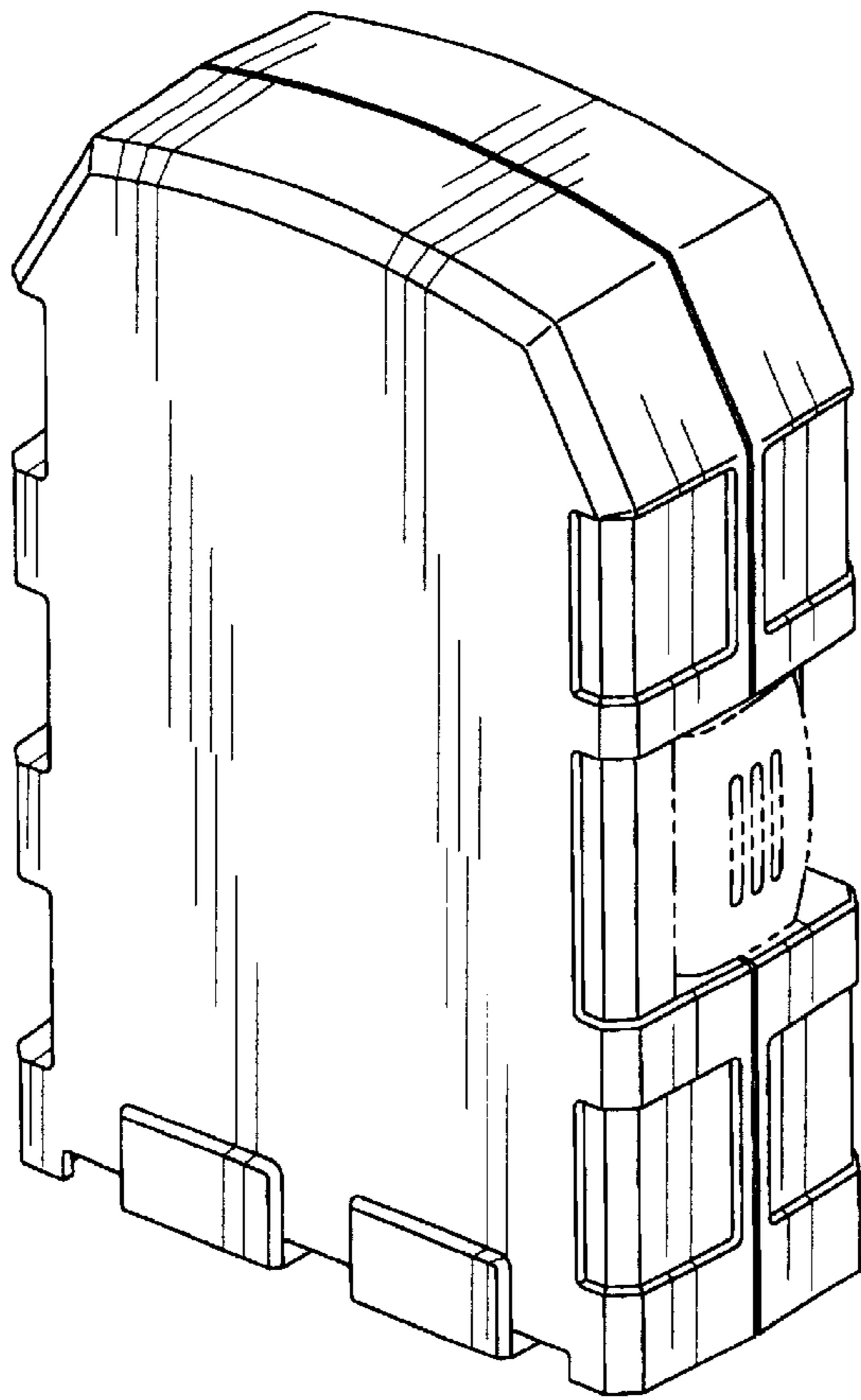

Fig-9

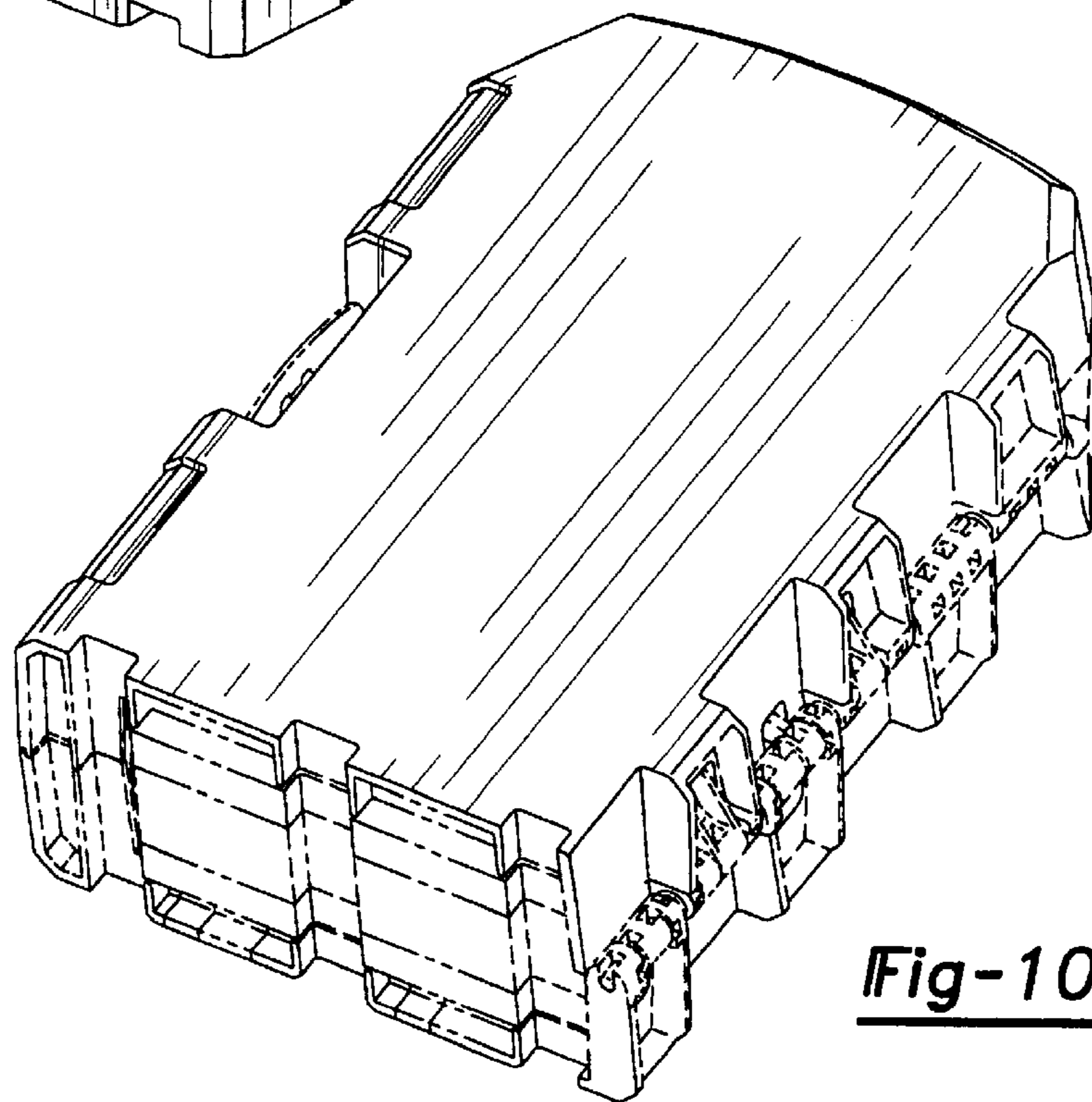

Fig-10

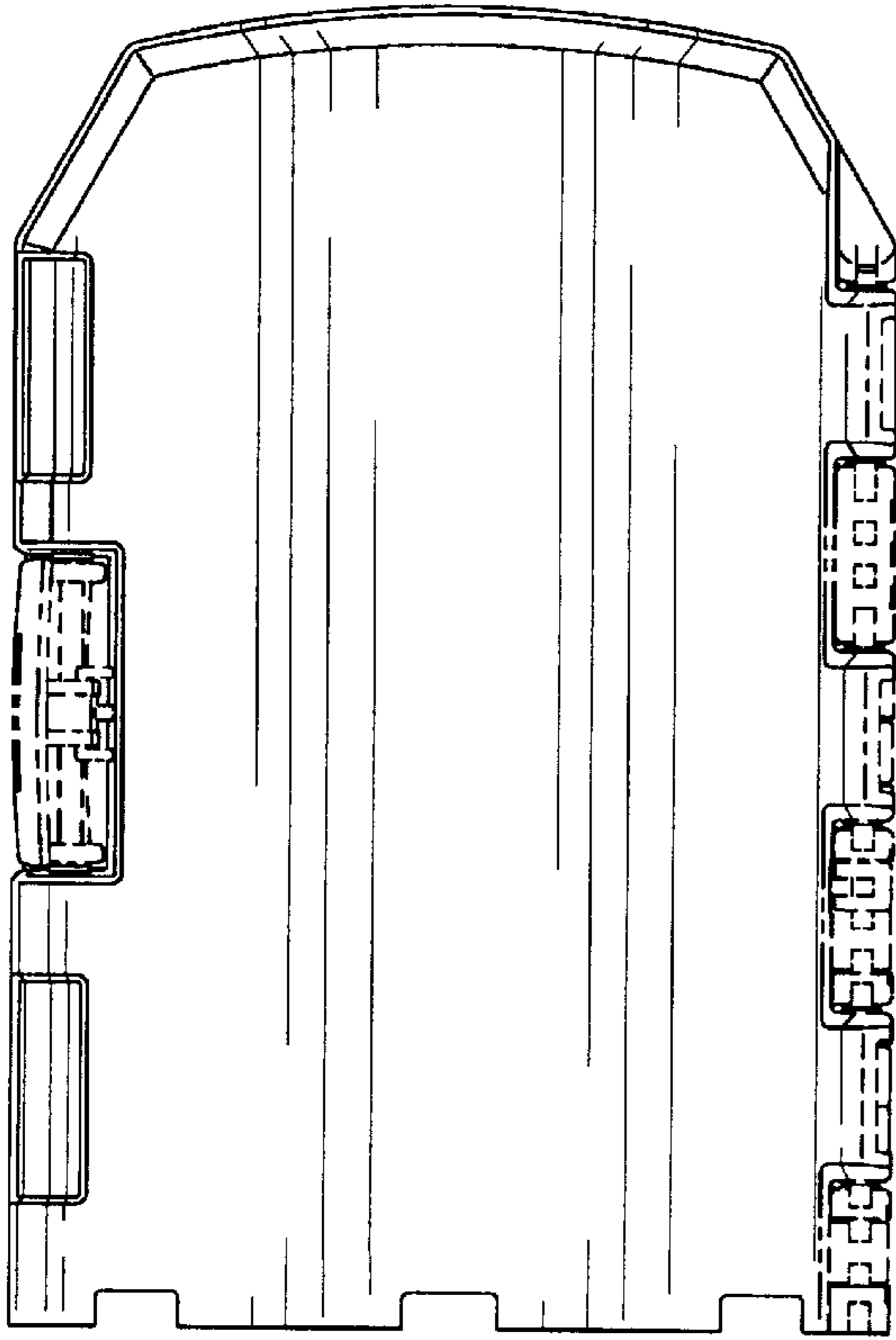

Fig-11

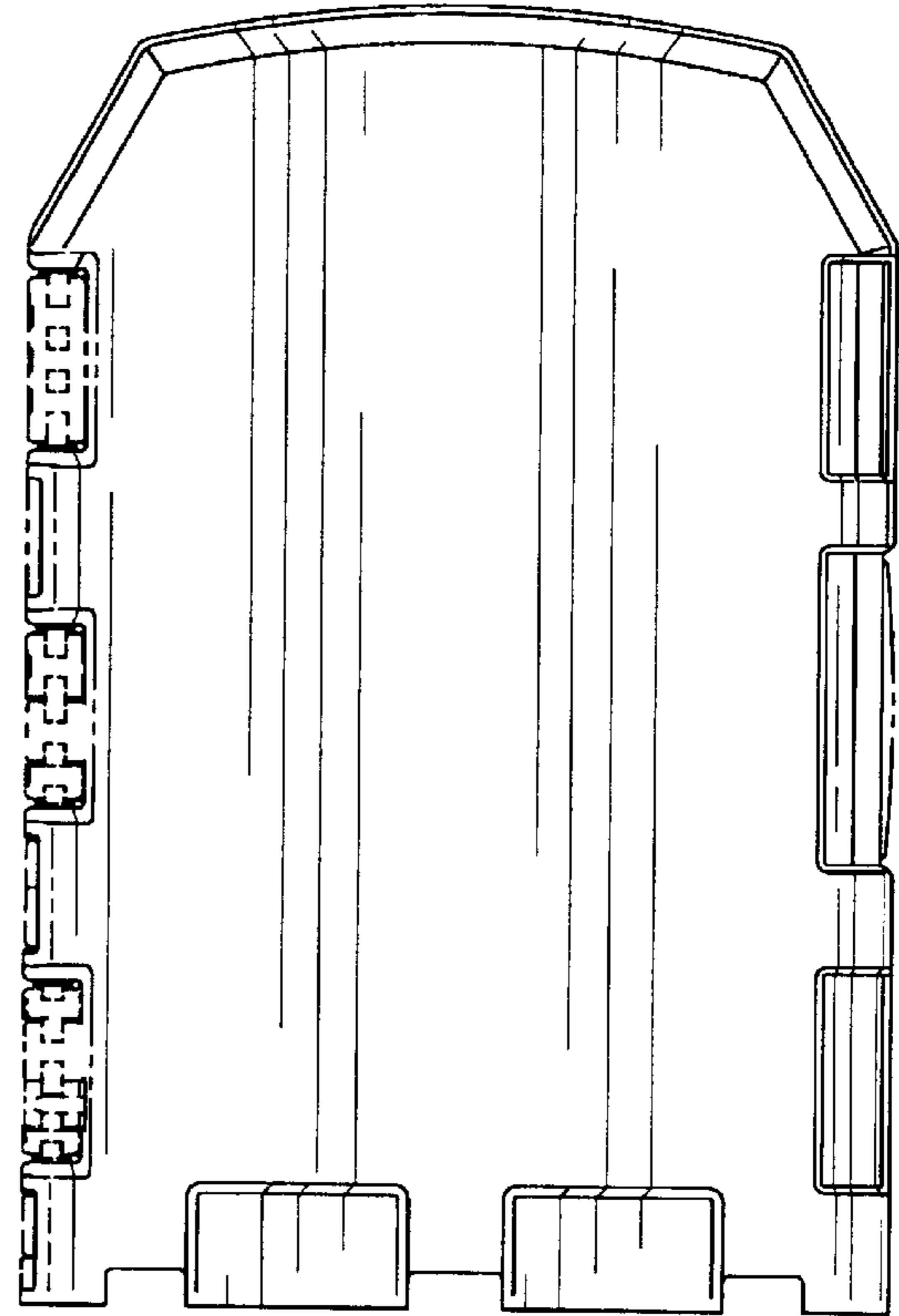

Fig-12

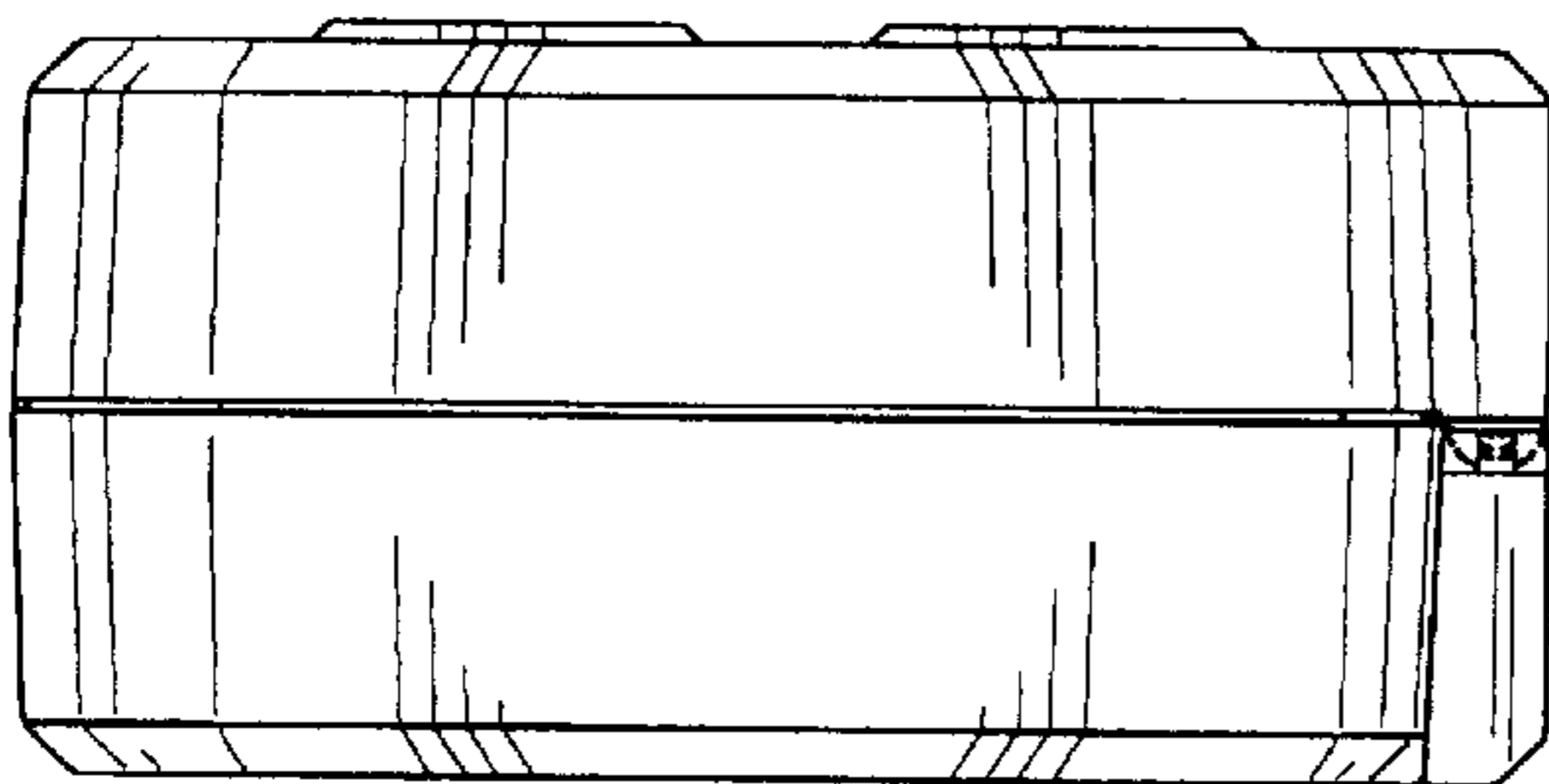

Fig-13

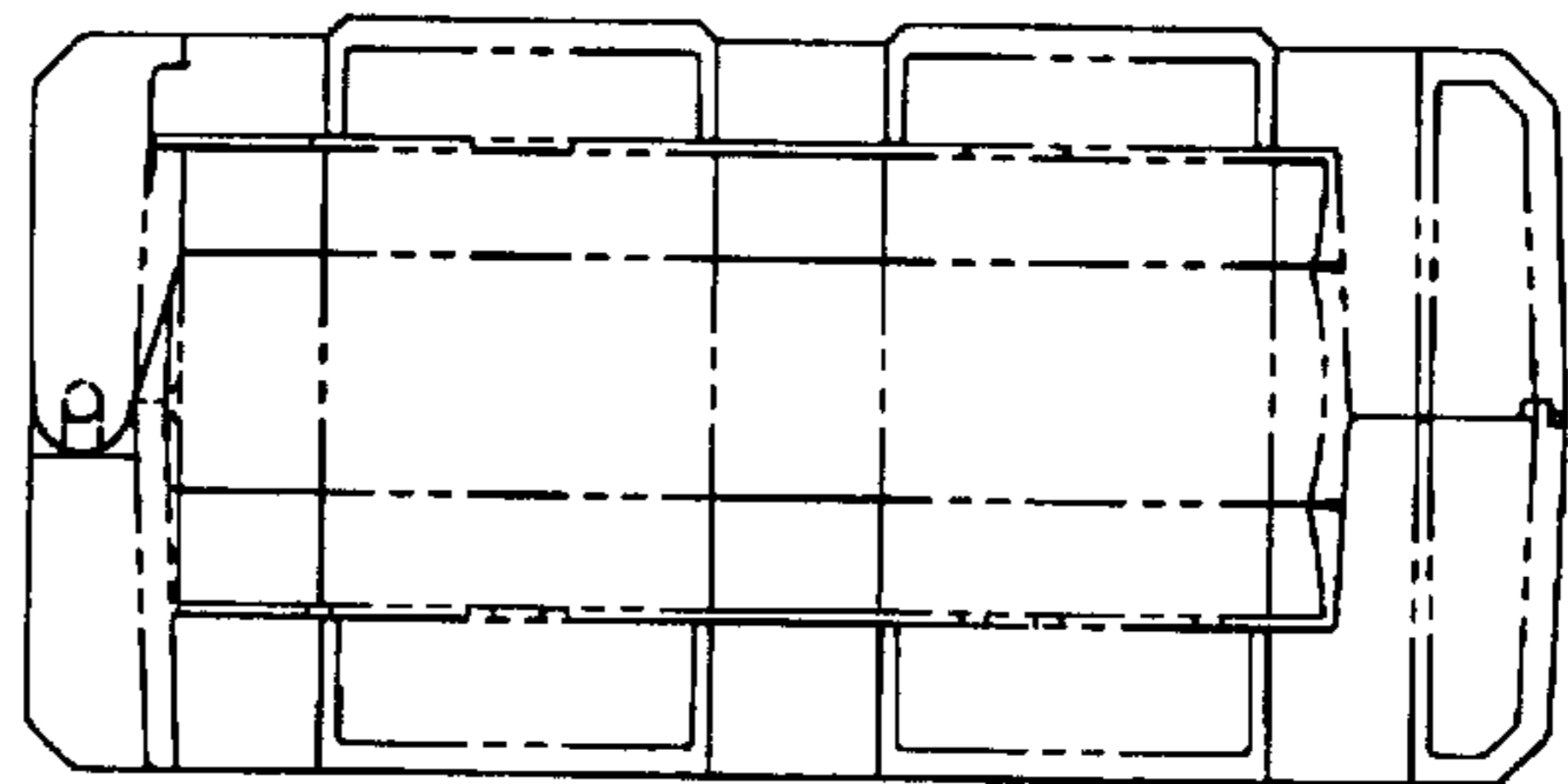

Fig-14

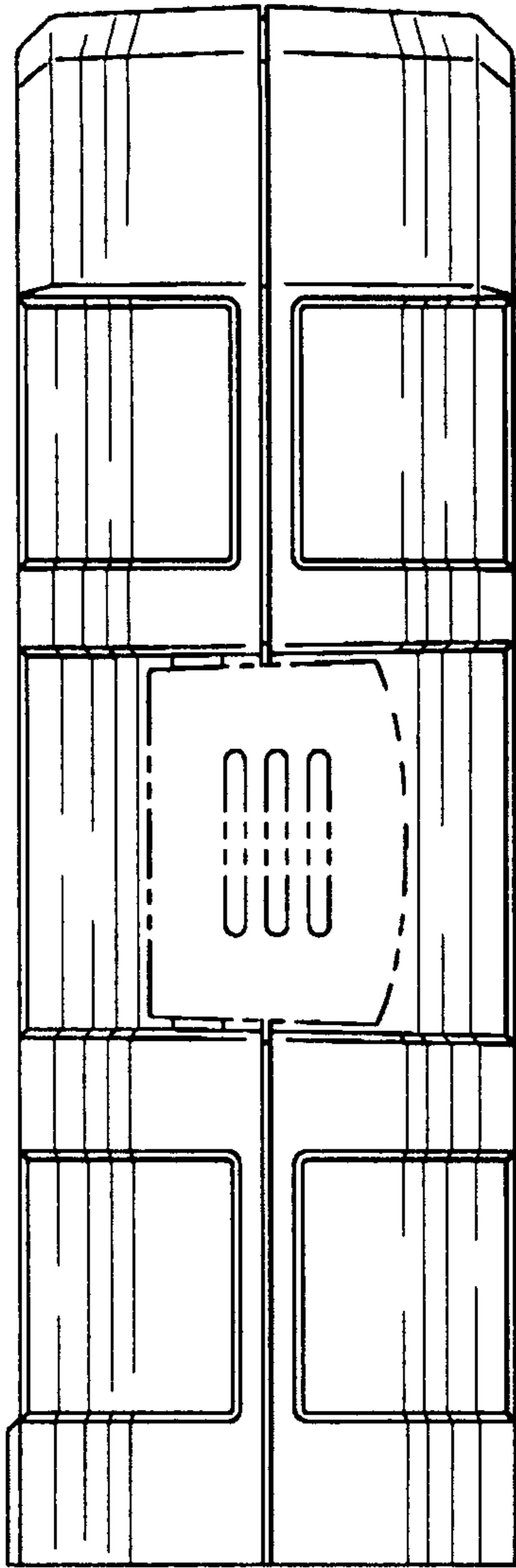

Fig-15

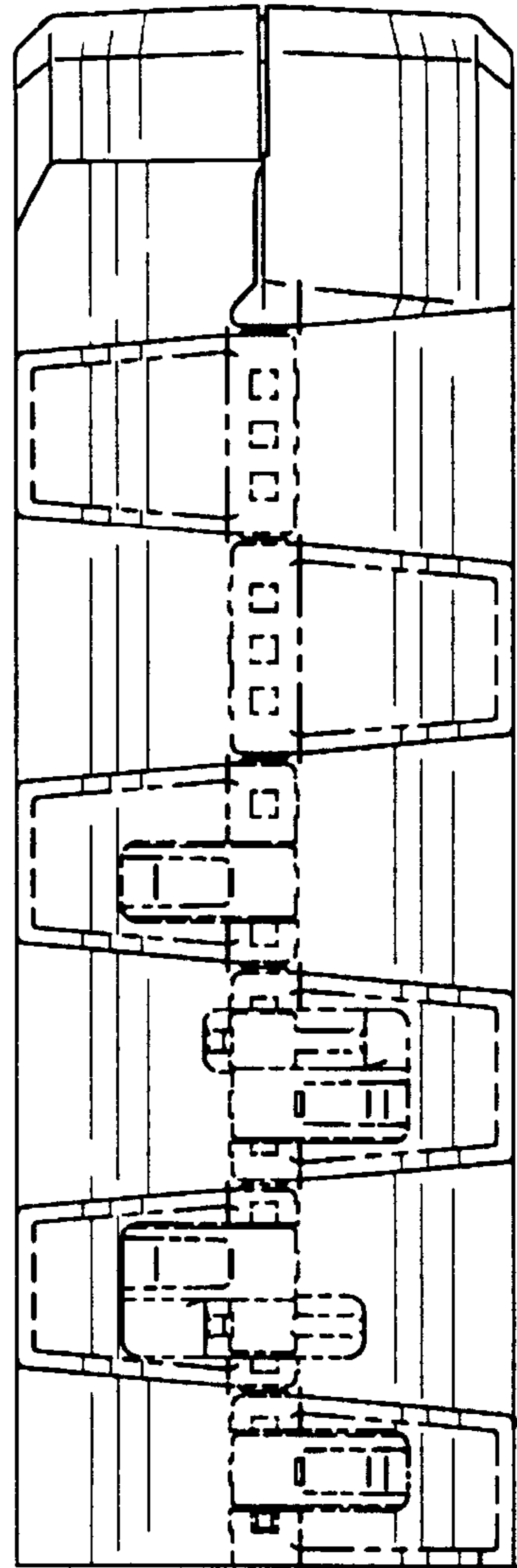

Fig-16