



US00D520699S

(12) **United States Design Patent**  
**Yang et al.**

(10) **Patent No.:** **US D520,699 S**

(45) **Date of Patent:** **\*\* May 9, 2006**

(54) **DISH RACK**

(75) Inventors: **Frank Yang**, Rancho Palos Verdes, CA (US); **Adam C. Wade**, Rancho Santa Margarita, CA (US); **Myk Wayne Lum**, Irvine, CA (US)

(73) Assignee: **Simplehuman LLC**, Los Angeles, CA (US)

(\*\*) Term: **14 Years**

(21) Appl. No.: **29/203,828**

(22) Filed: **Apr. 19, 2004**

(51) **LOC (8) Cl.** ..... **07-05**

(52) **U.S. Cl.** ..... **D32/55**

(58) **Field of Classification Search** ..... D32/55,  
D32/56; 4/637, 656; 211/41.2-41.4, 41.8,  
211/41.9, 85.25, 126.8, 126.9, 181.1; 220/485,  
220/487, 488, 494, 572

See application file for complete search history.

(56) **References Cited**

**U.S. PATENT DOCUMENTS**

D97,654 S \* 11/1935 Watral ..... D32/55

D189,311 S \* 11/1960 Christoffersen ..... D32/55  
D271,339 S \* 11/1983 Lee ..... D32/55  
D321,771 S \* 11/1991 Cavicchia ..... D32/55  
D373,866 S \* 9/1996 Belden et al. .... D32/55

\* cited by examiner

*Primary Examiner*—Alan P. Douglas

*Assistant Examiner*—Lavone D. Tabor

(74) *Attorney, Agent, or Firm*—Raymond Sun

(57) **CLAIM**

The ornamental design for a dish rack, as shown and described.

**DESCRIPTION**

FIG. 1 is a perspective view of a dish rack according to the present invention.

FIG. 2 is a top plan view of the dish rack of FIG. 1;

FIG. 3 is a bottom plan view of the dish rack of FIG. 1;

FIG. 4 is a front view of the dish rack of FIG. 1, the rear plan view being symmetrical thereto;

FIG. 5 is one side view of the dish rack of FIG. 1; and,

FIG. 6 is another side view of the dish rack of FIG. 1.

**1 Claim, 6 Drawing Sheets**

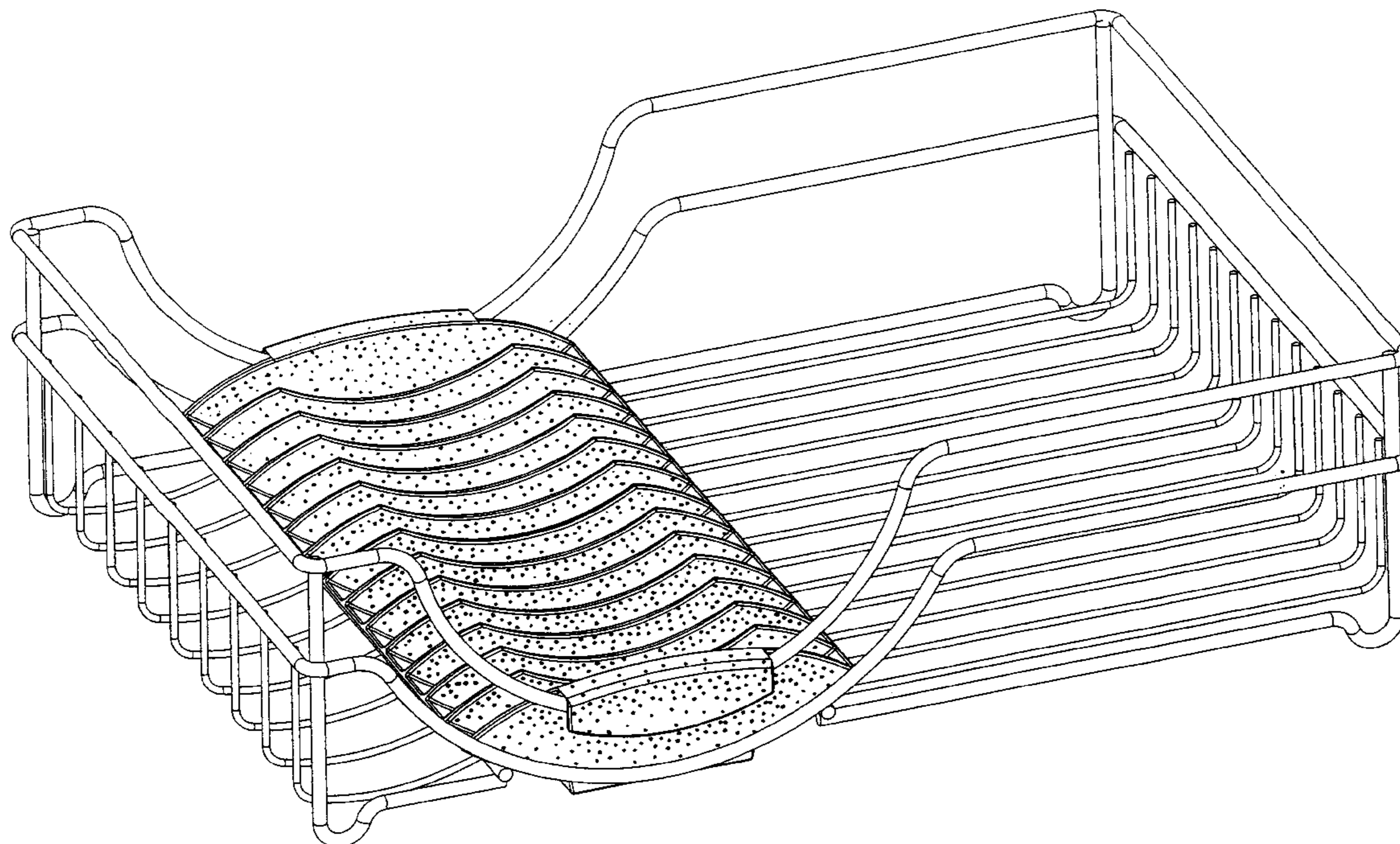

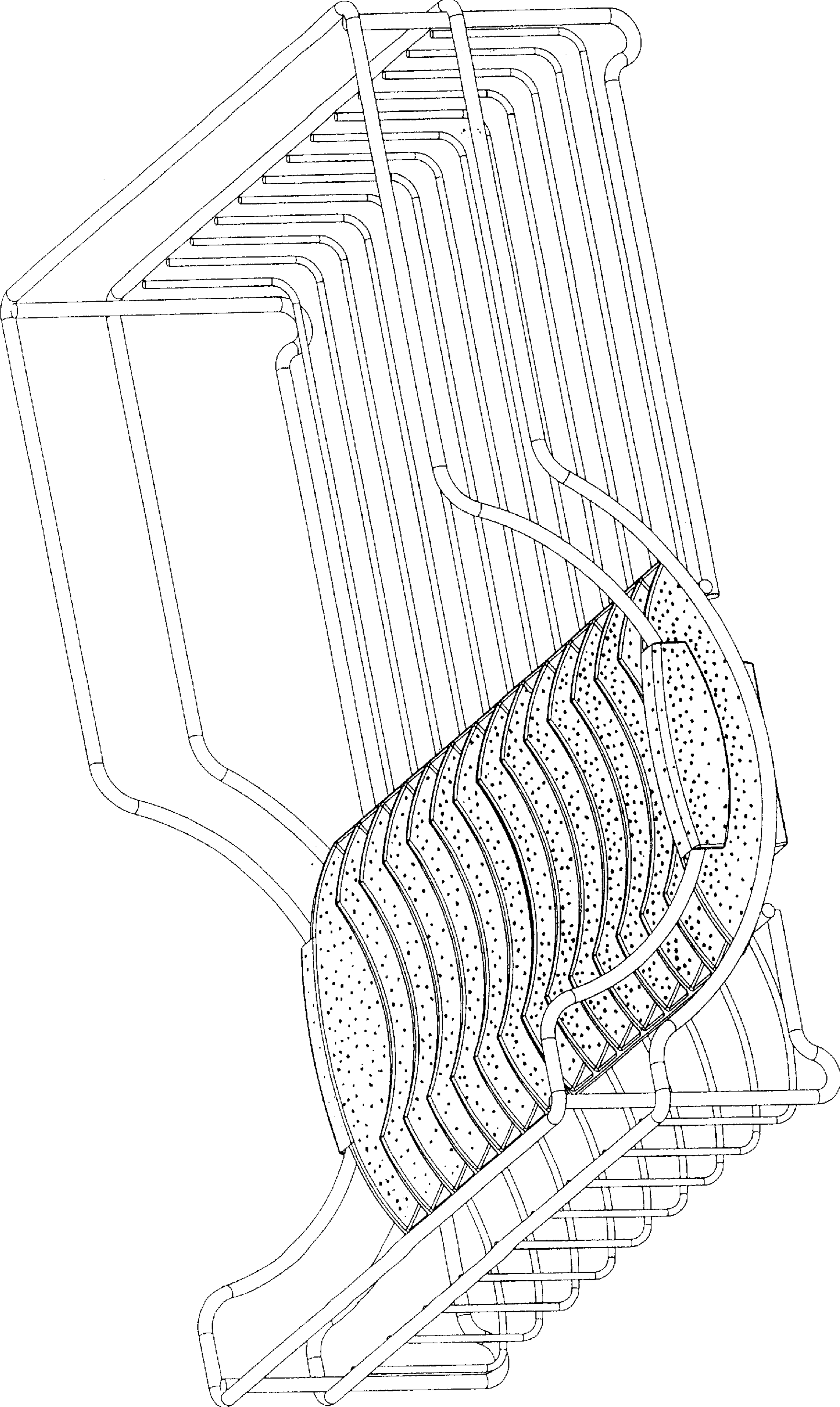

FIG. 1

FIG. 2

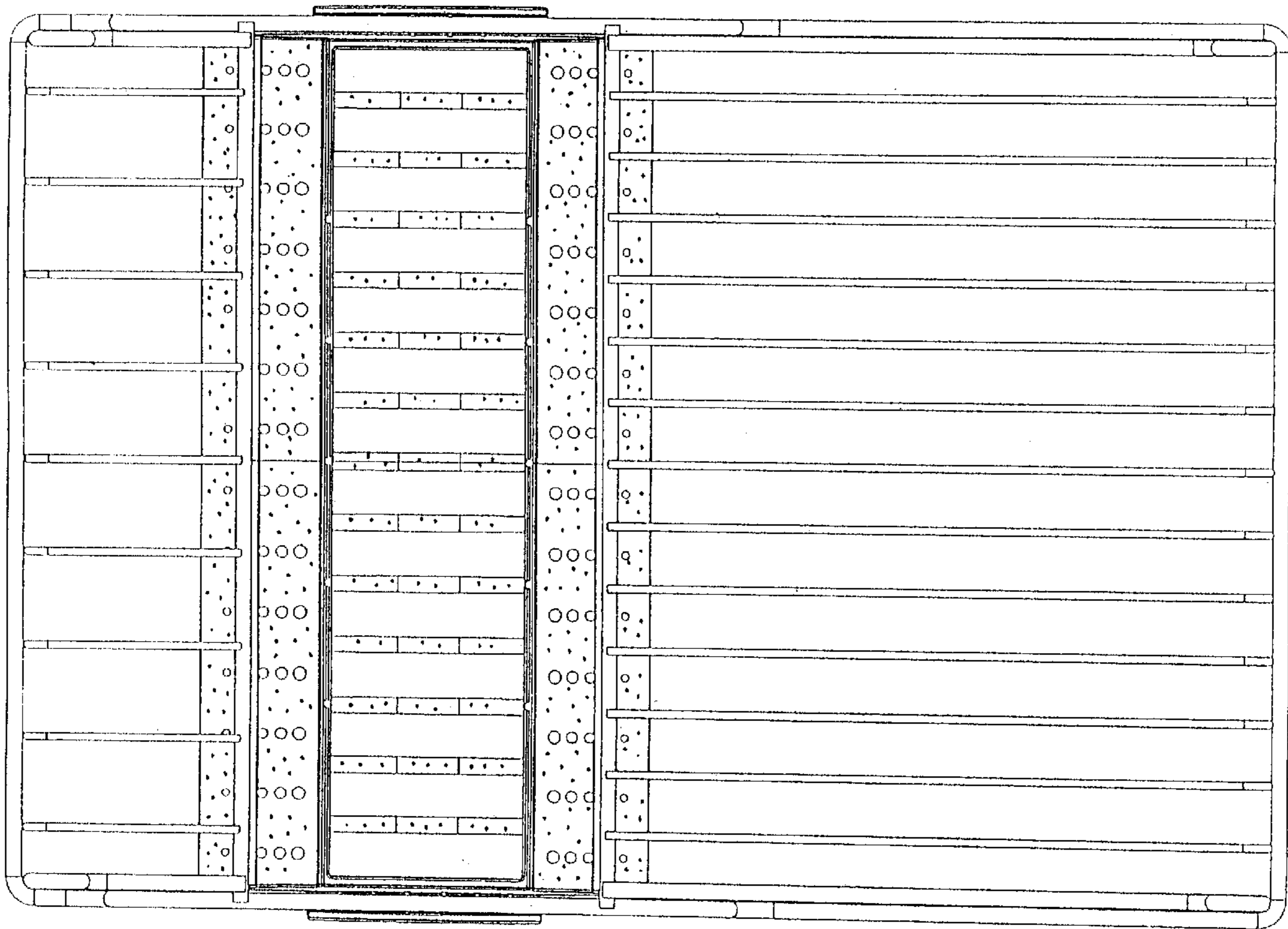
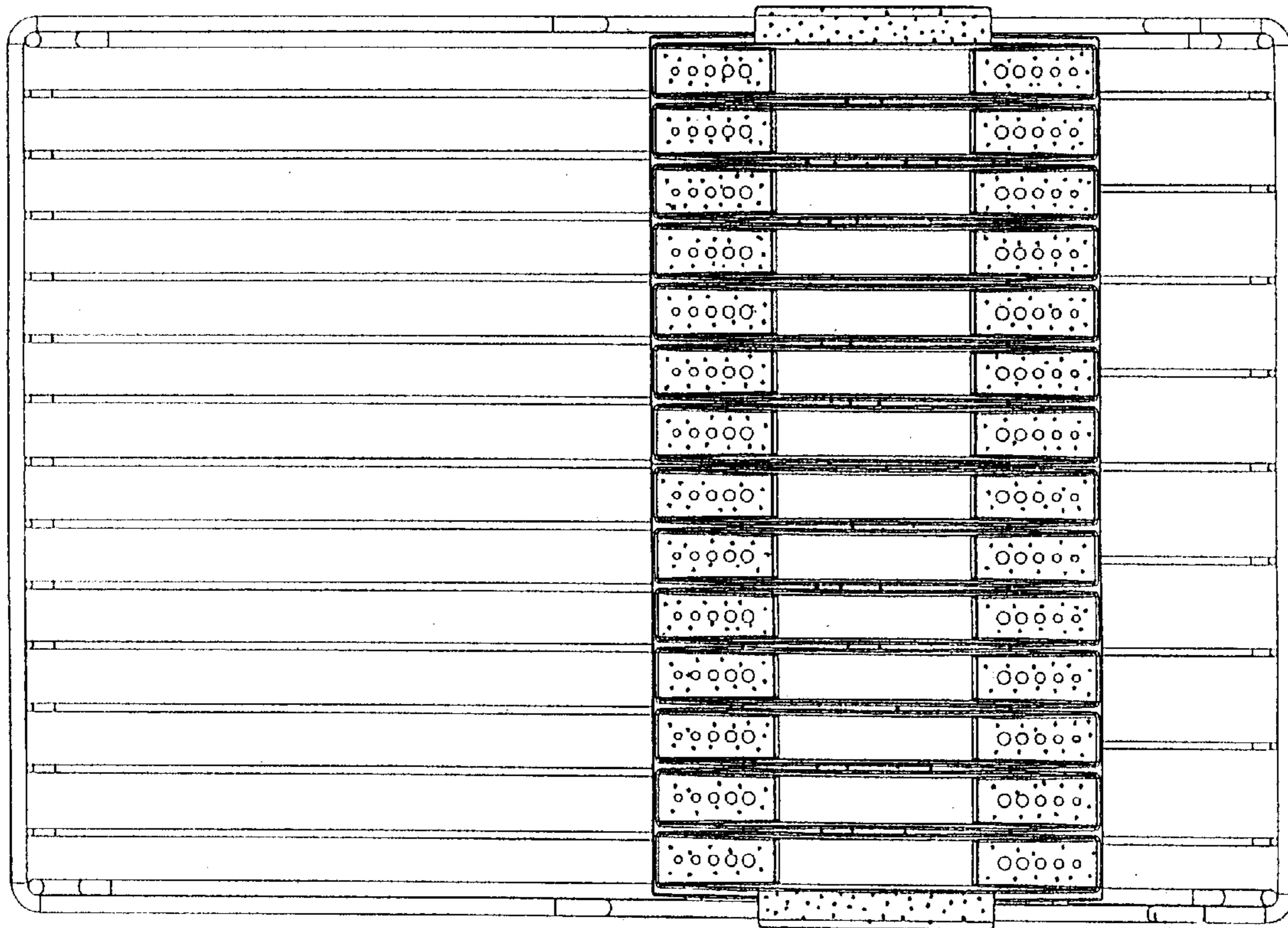

FIG. 3



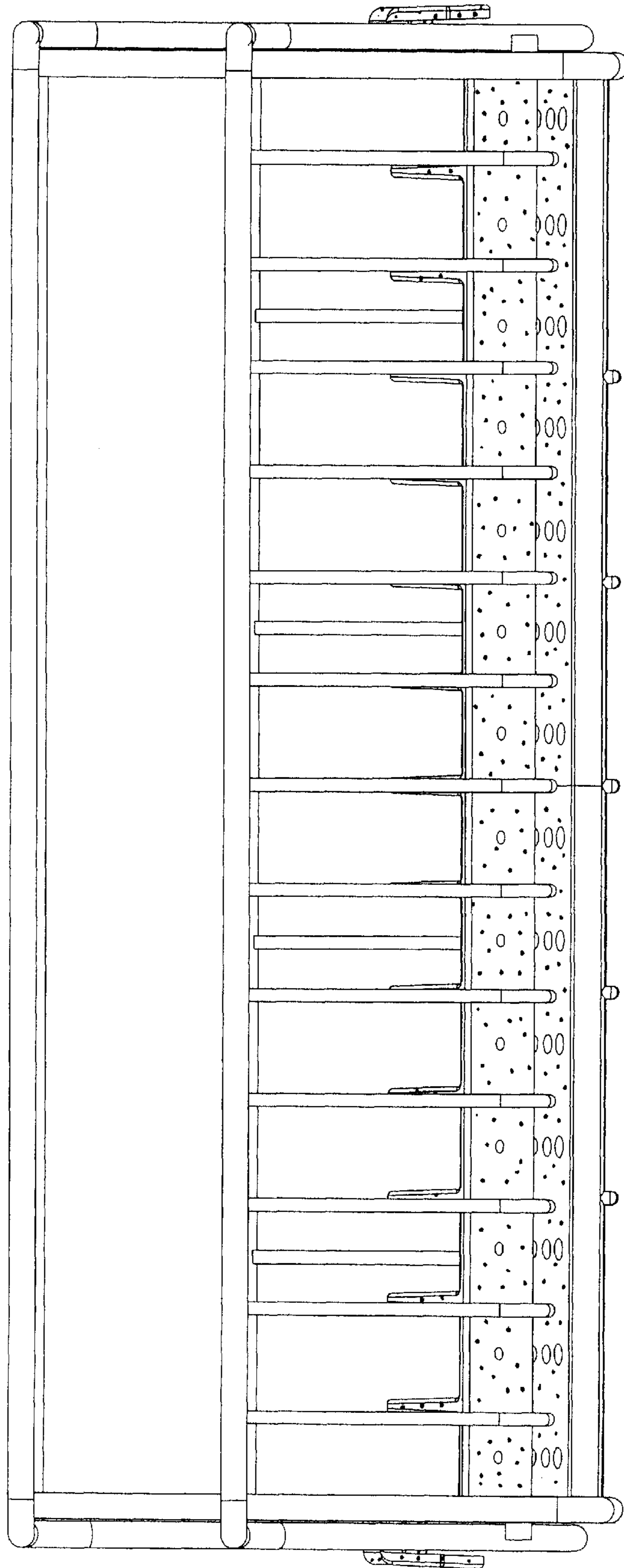

FIG. 4

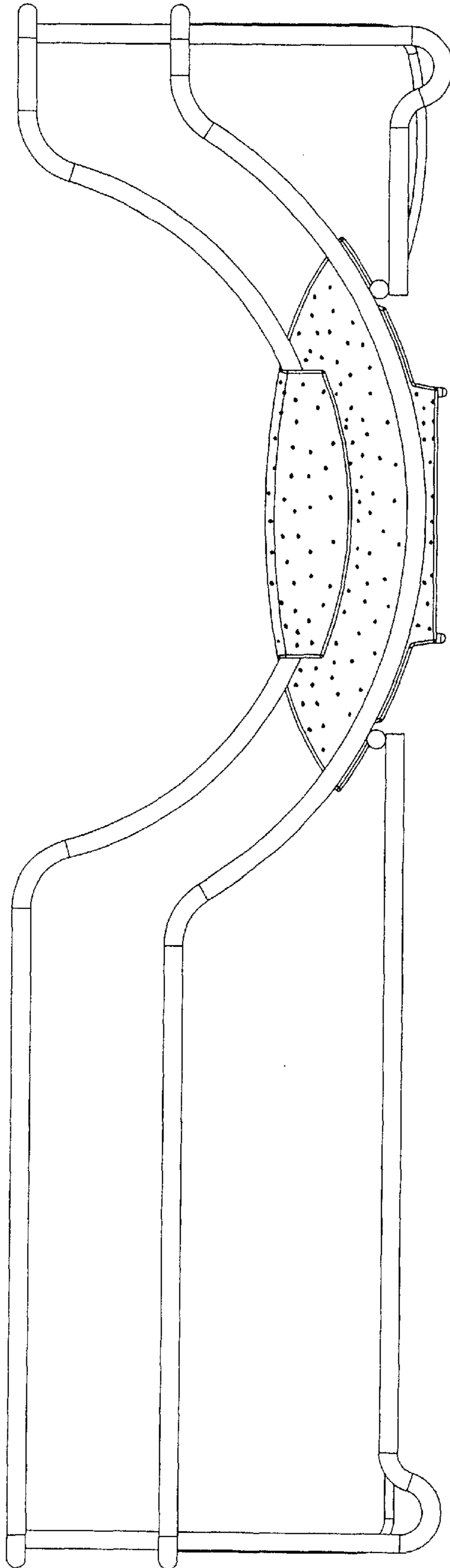

FIG. 5

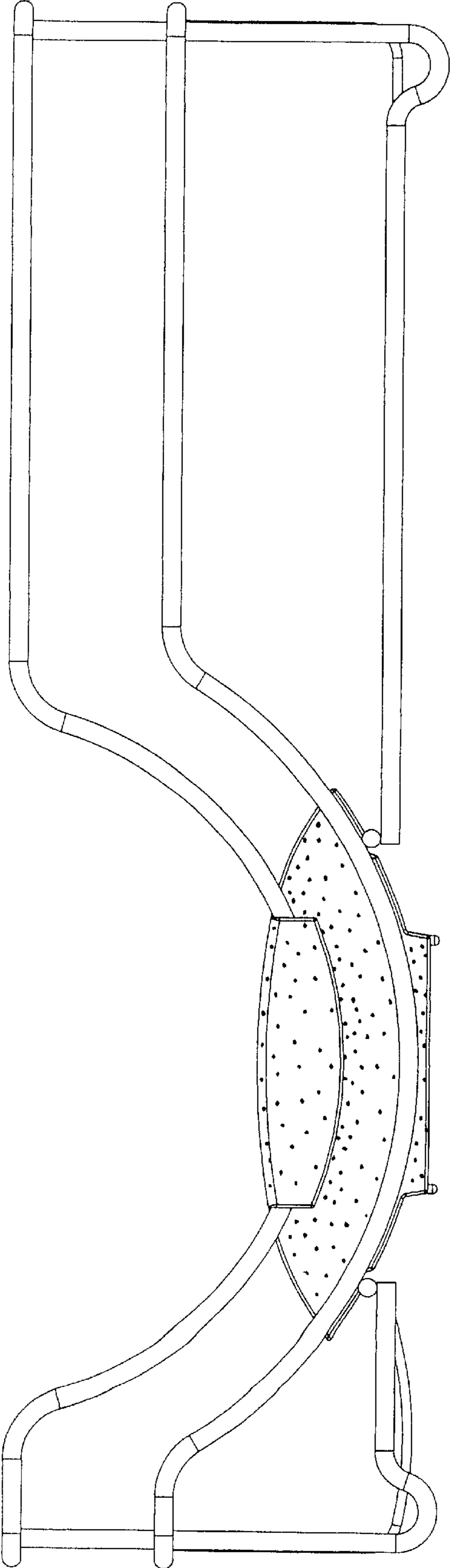

FIG. 6