



US00D520643S

(12) **United States Design Patent** (10) **Patent No.:** **US D520,643 S**
Clarke et al. (45) **Date of Patent:** **** May 9, 2006**

(54) **TOOL FOR LABORATORIES**

(57) **CLAIM**

(75) Inventors: **John Clarke**, Ballinasloe (IE); **Peter Le Feuvre**, Castel (GB); **David Inder**, Vale (GB)

The ornamental design for a tool for laboratories, as shown and described.

DESCRIPTION

(73) Assignee: **Enfer Technology Limited**, Dublin (IE)

FIG. 1 is a front view of a tool for laboratories showing our new design;

(**) Term: **14 Years**

FIG. 2 is a bottom view thereof;

(21) Appl. No.: **29/205,396**

FIG. 3 is a top view thereof;

(22) Filed: **May 13, 2004**

FIG. 4 is a perspective view thereof taken from the bottom and right;

(30) **Foreign Application Priority Data**

Nov. 14, 2003 (EM) 000099544

FIG. 5 is a perspective view thereof taken from the top and left;

(51) **LOC (8) Cl.** **24-04**

FIG. 6 is a left side view thereof;

(52) **U.S. Cl.** **D24/216**

FIG. 7 is a left side perspective view taken from the top and right with the cap removed;

(58) **Field of Classification Search** D24/108,
D24/121, 217, 224, 216, 231, 163; 600/562;
422/100, 102

FIG. 8 is a right side perspective view taken from the bottom and left with the cap removed;

See application file for complete search history.

FIG. 9 is an enlarged front view with the cap removed and without the inner portion;

(56) **References Cited**

U.S. PATENT DOCUMENTS

4,505,433 A 3/1985 Selenke

FIG. 10 is a front view of the inner portion of the design;

FOREIGN PATENT DOCUMENTS

WO WO 2005/047866 5/2005

FIG. 11 is a perspective view taken from the top and left of FIG. 10;

Primary Examiner—Louis S. Zarfaz

Assistant Examiner—Melanie Levy

FIG. 12 is a perspective view taken from the bottom and right of FIG. 10;

(74) *Attorney, Agent, or Firm*—Patterson & Sheridan, LLP

FIG. 13 is a bottom view of FIG. 10;

FIG. 14 is a top view of FIG. 10;

FIG. 15 is an enlarged perspective view of the lid;

FIG. 16 is an enlarged side view of FIG. 15; and,

FIG. 17 is an enlarged perspective view taken from the bottom and left of FIG. 15.

1 Claim, 7 Drawing Sheets

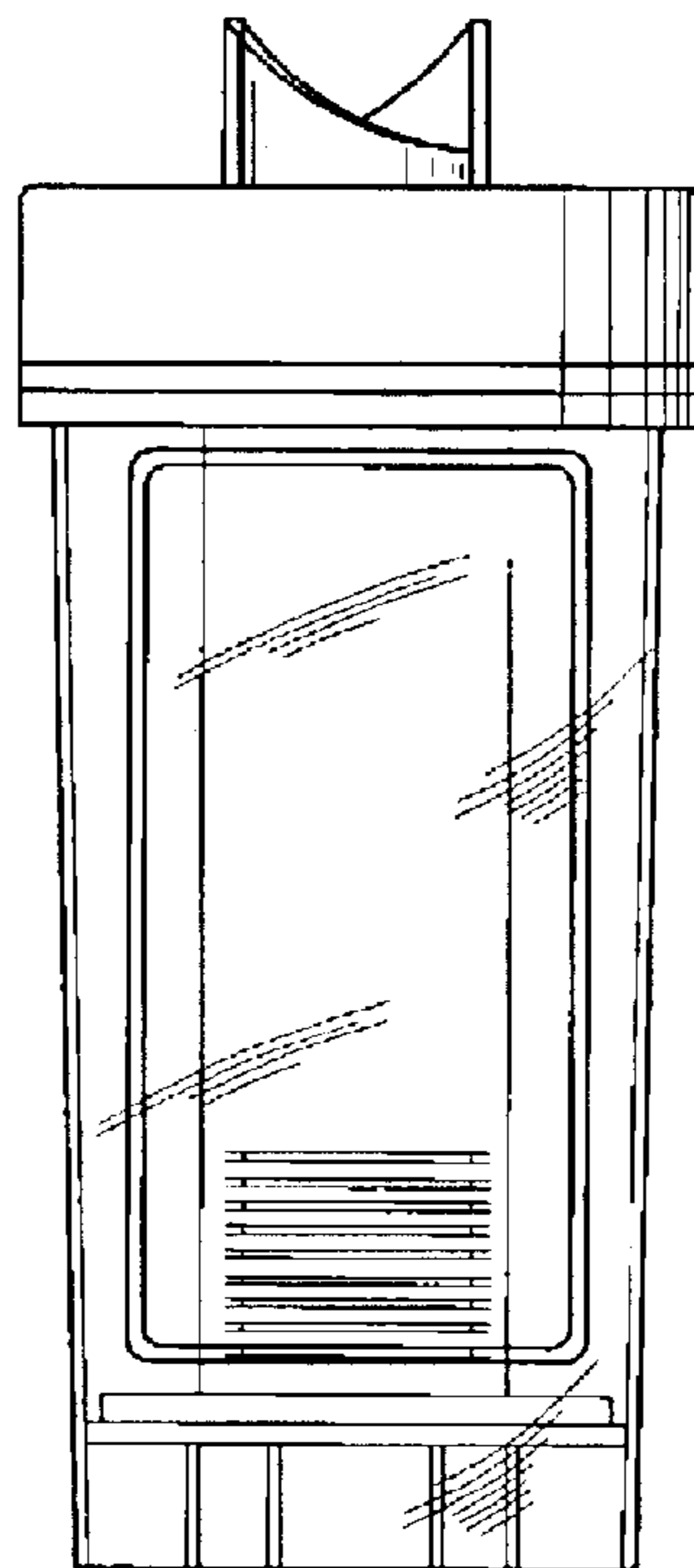

FIG. 1

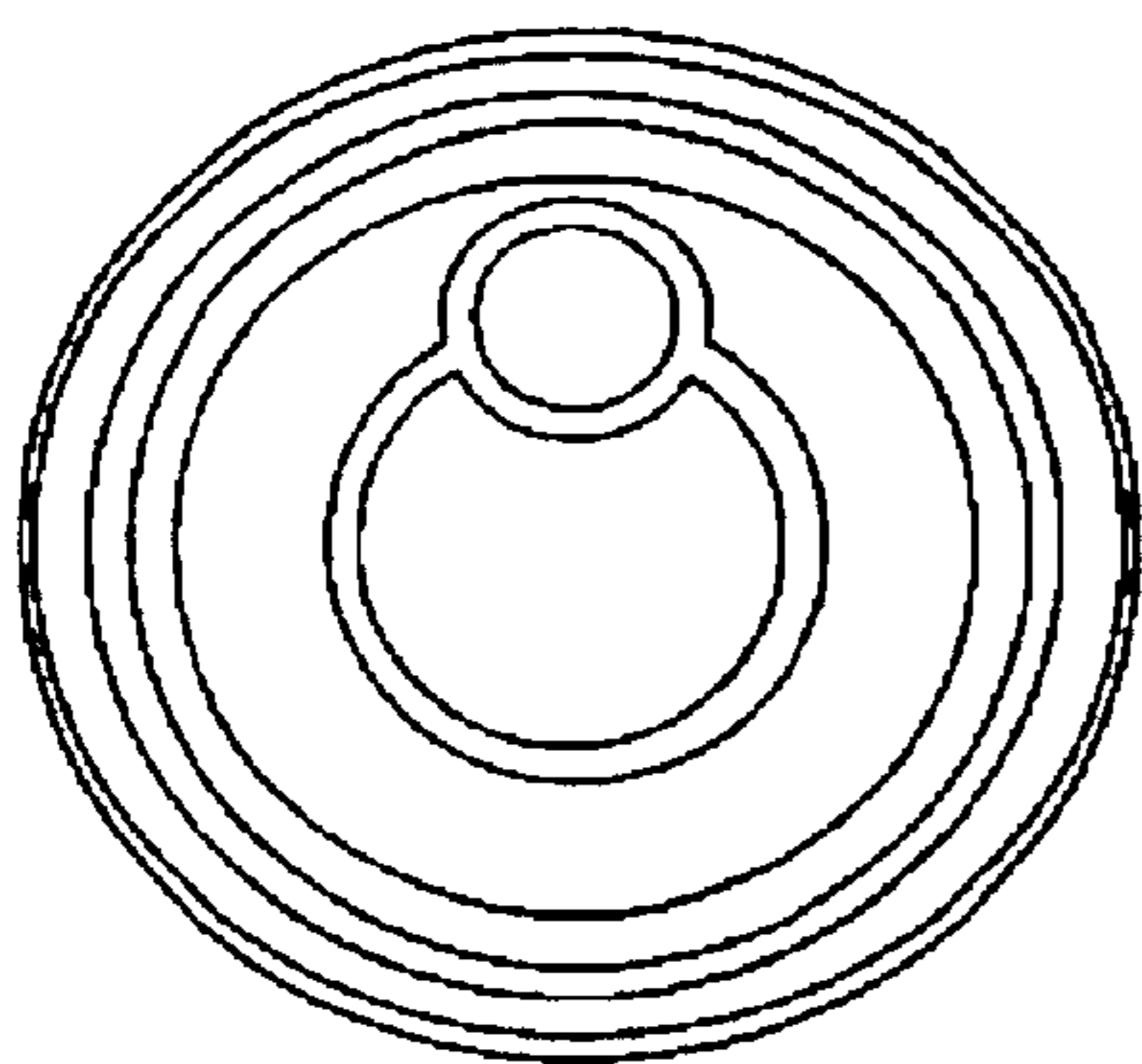
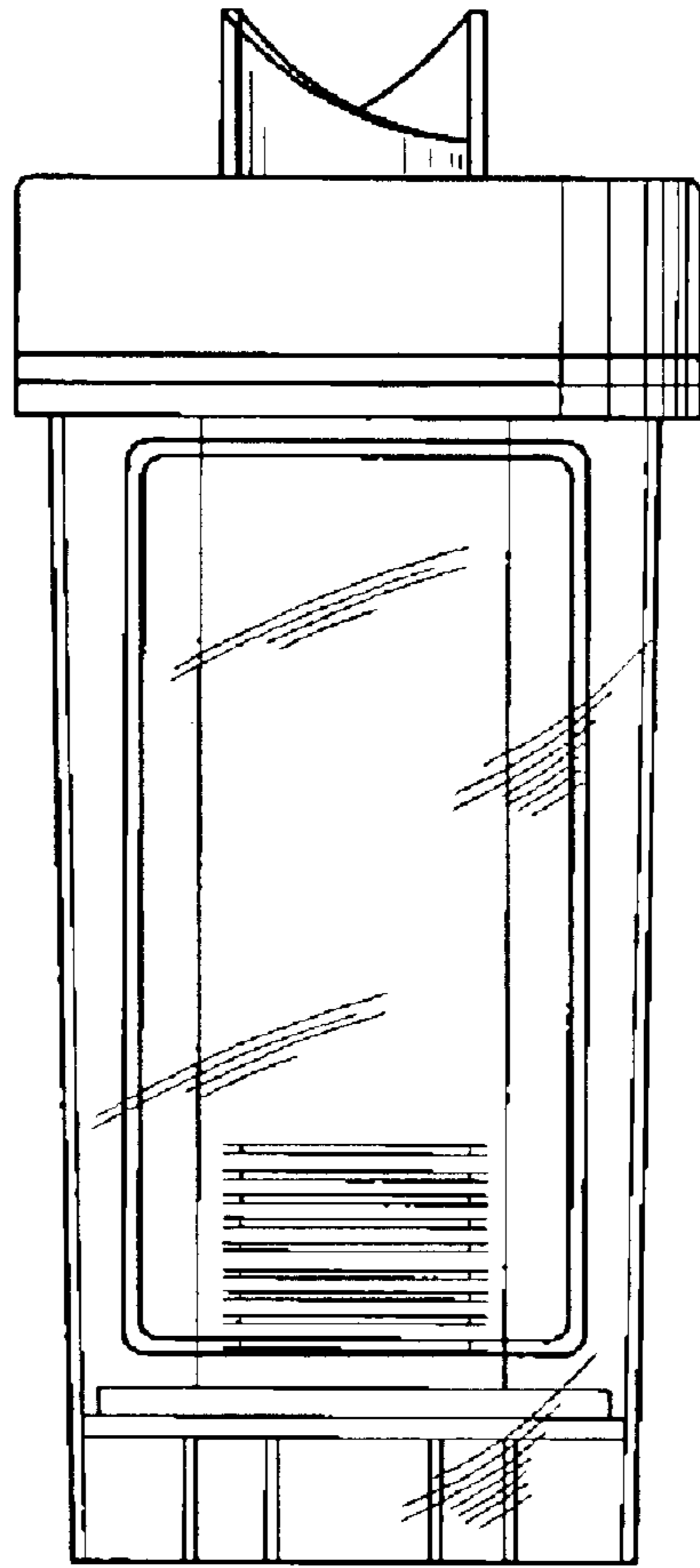

FIG. 2

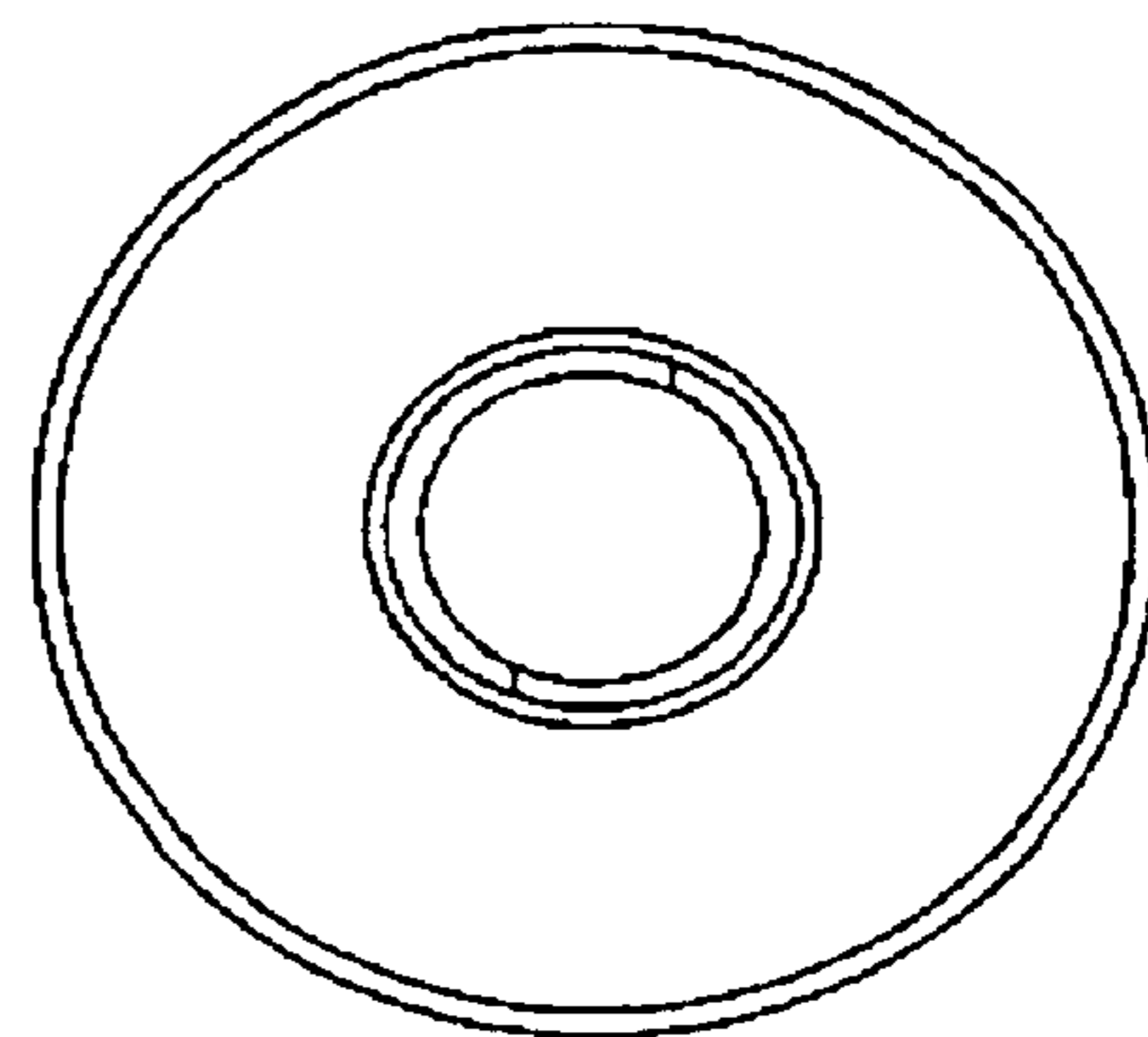

FIG. 3

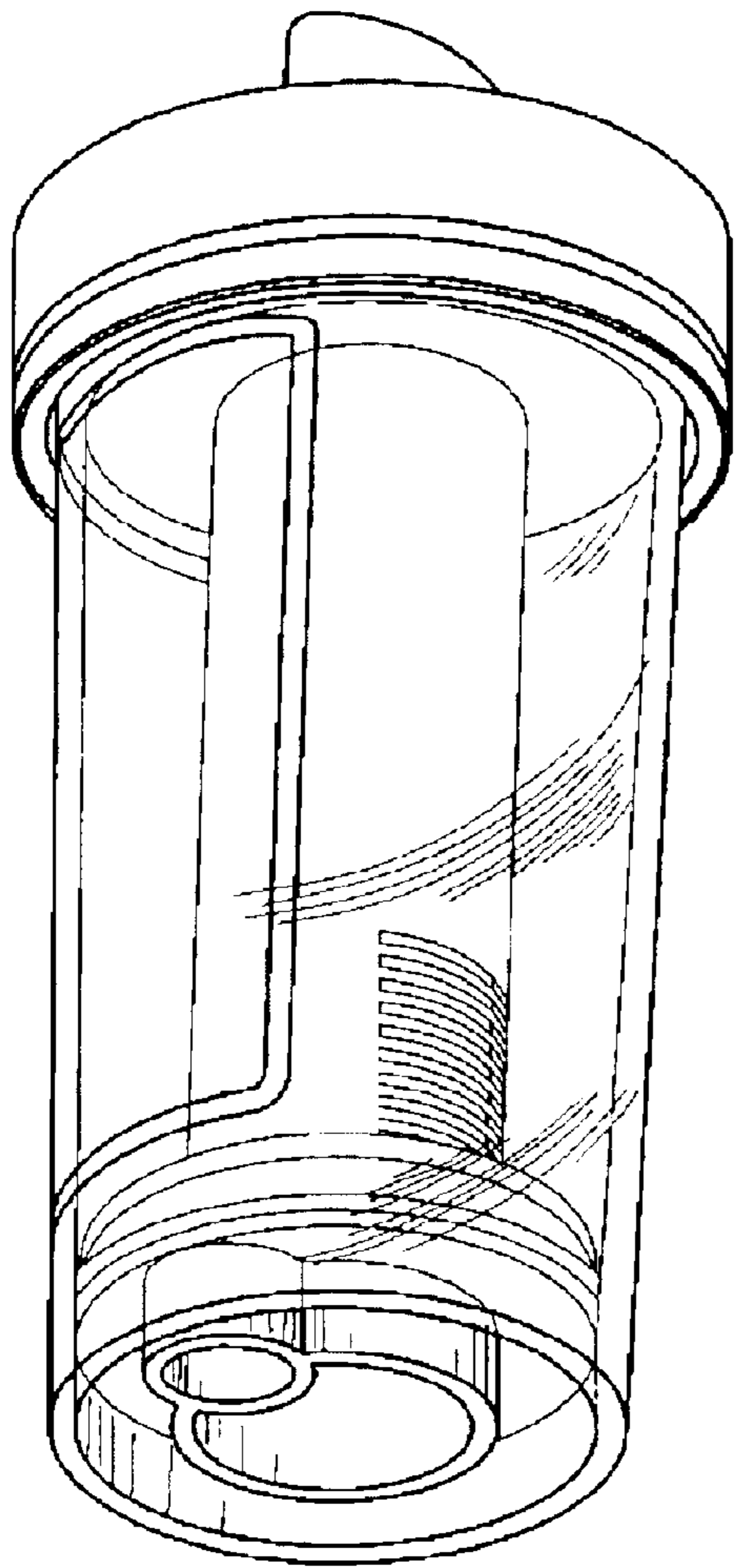

FIG. 4

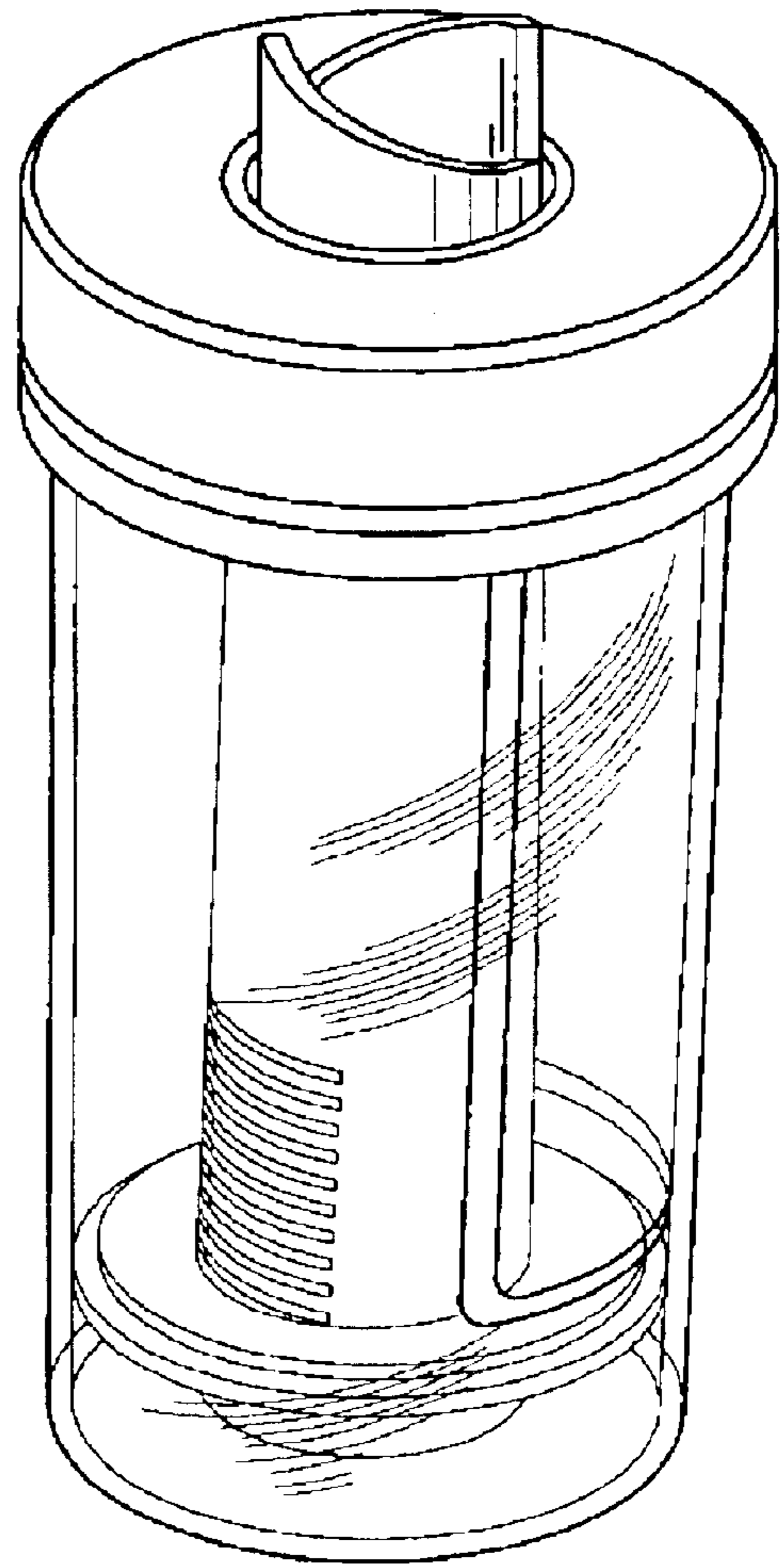

FIG. 5

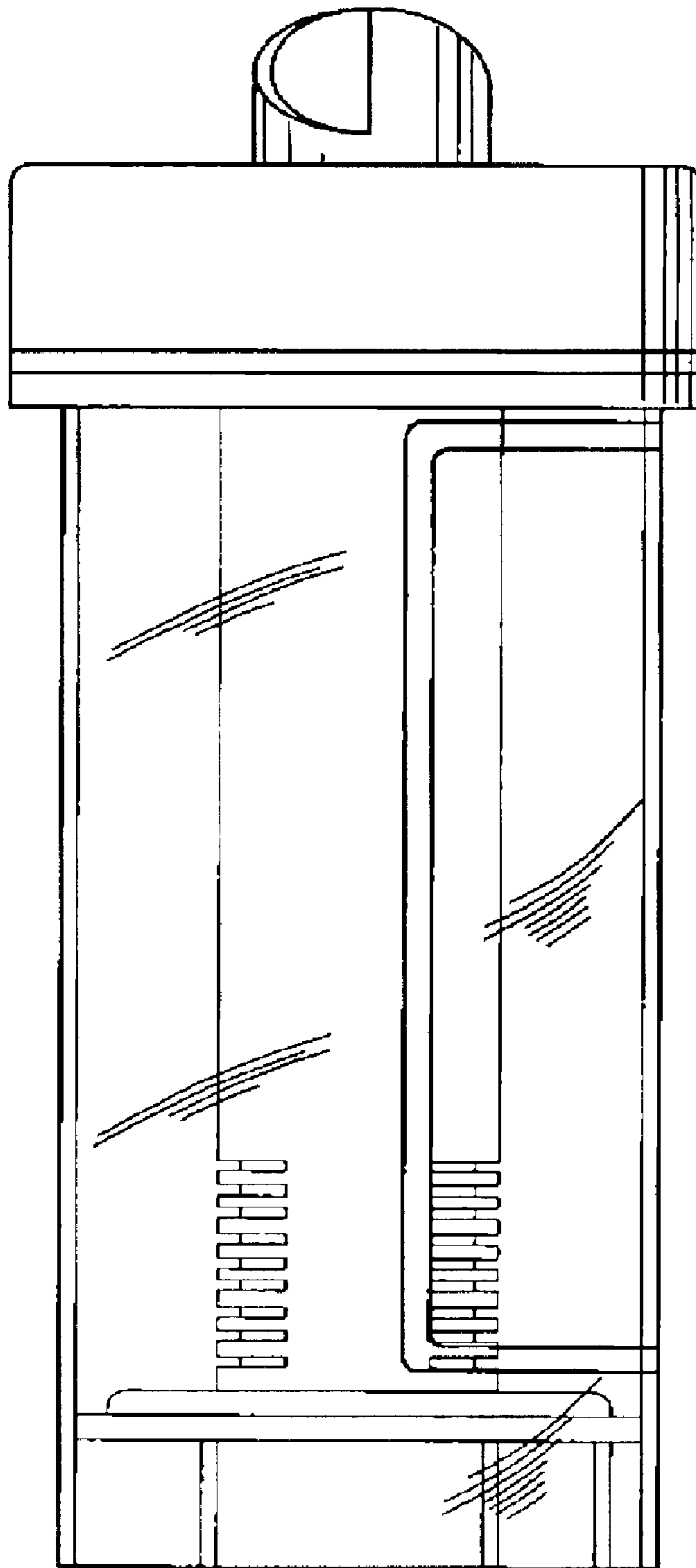

FIG. 6

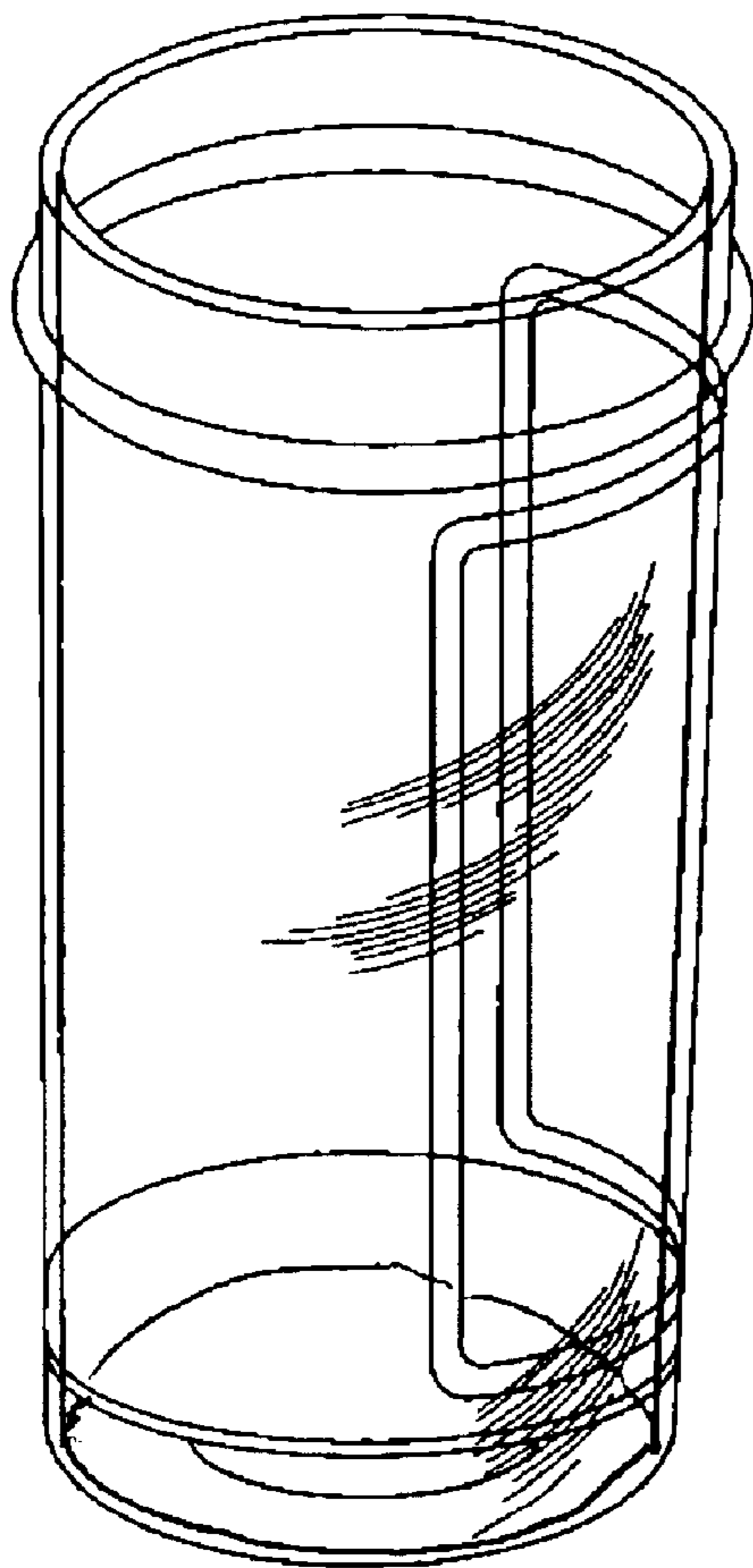

FIG. 7

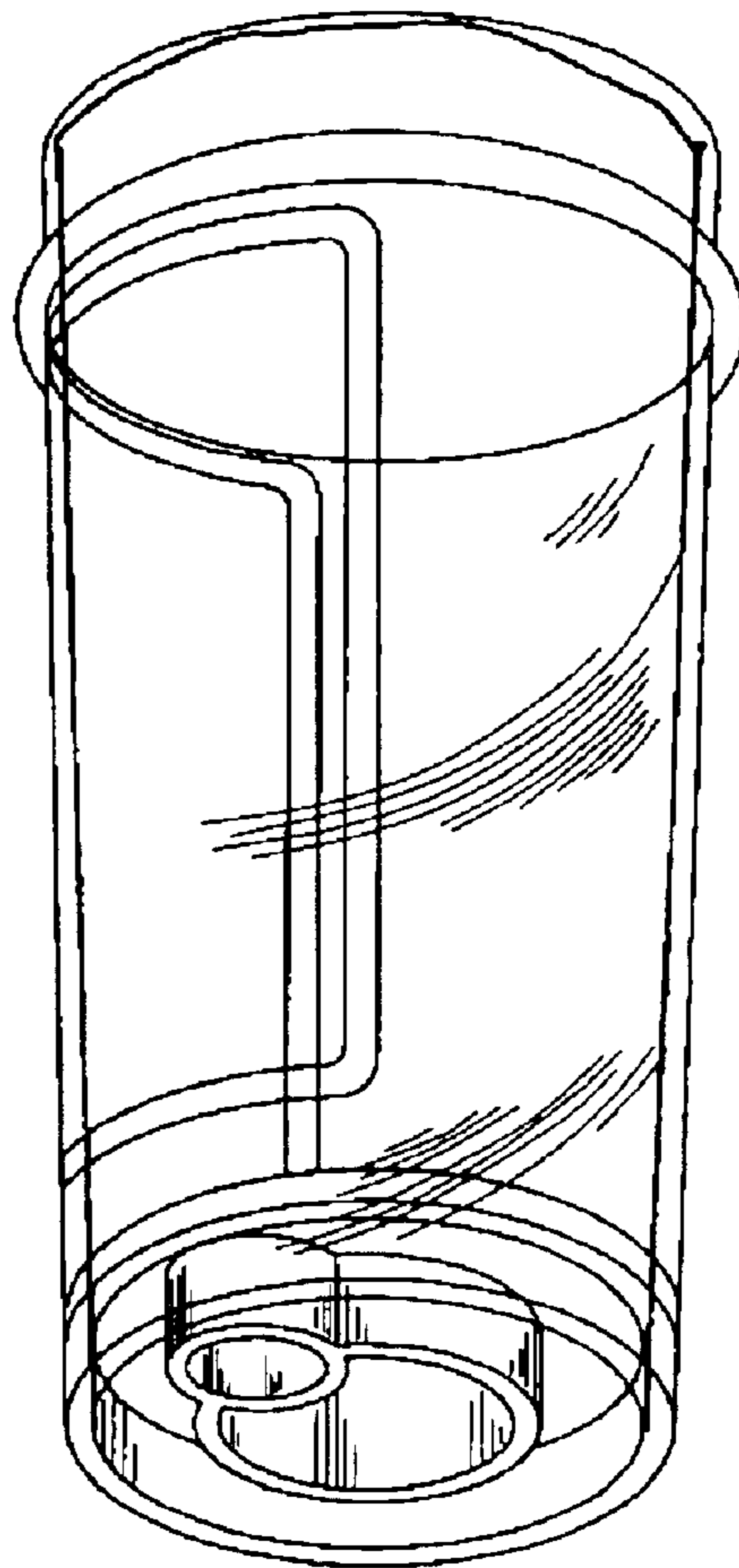

FIG. 8

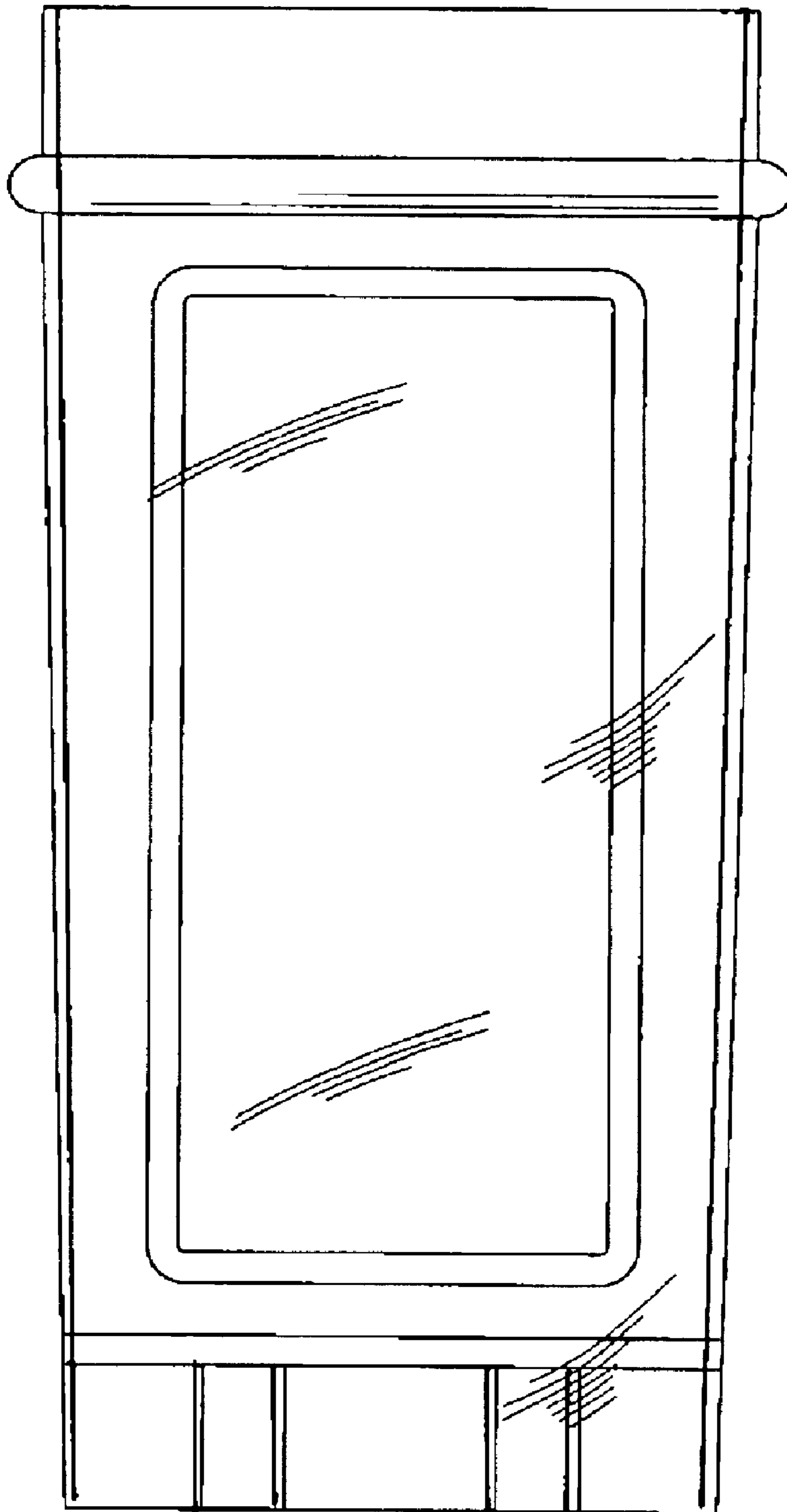

FIG. 9

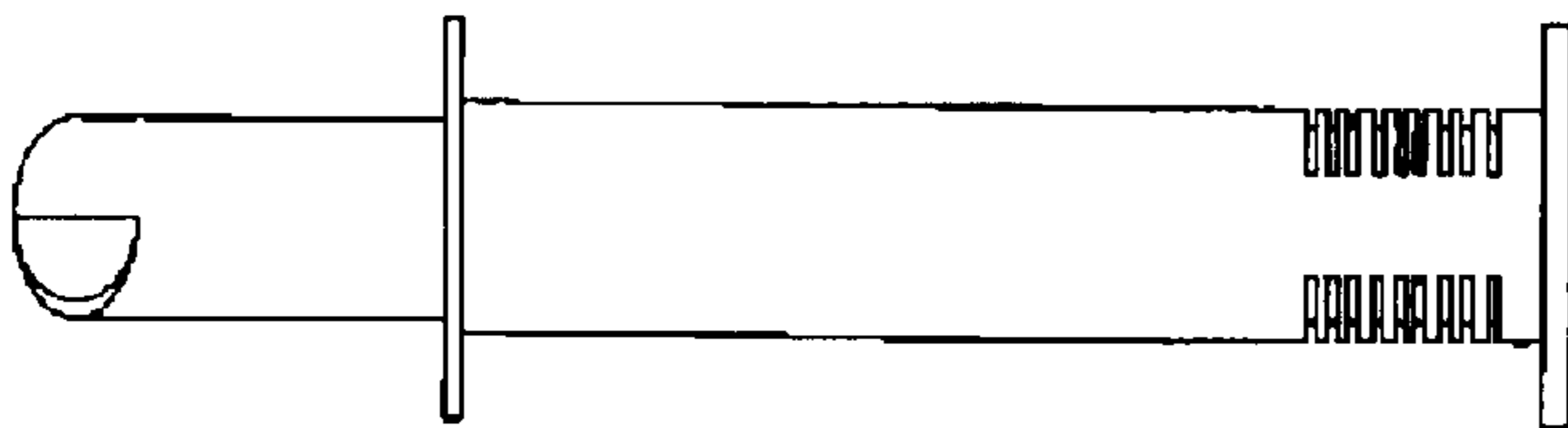

FIG. 10

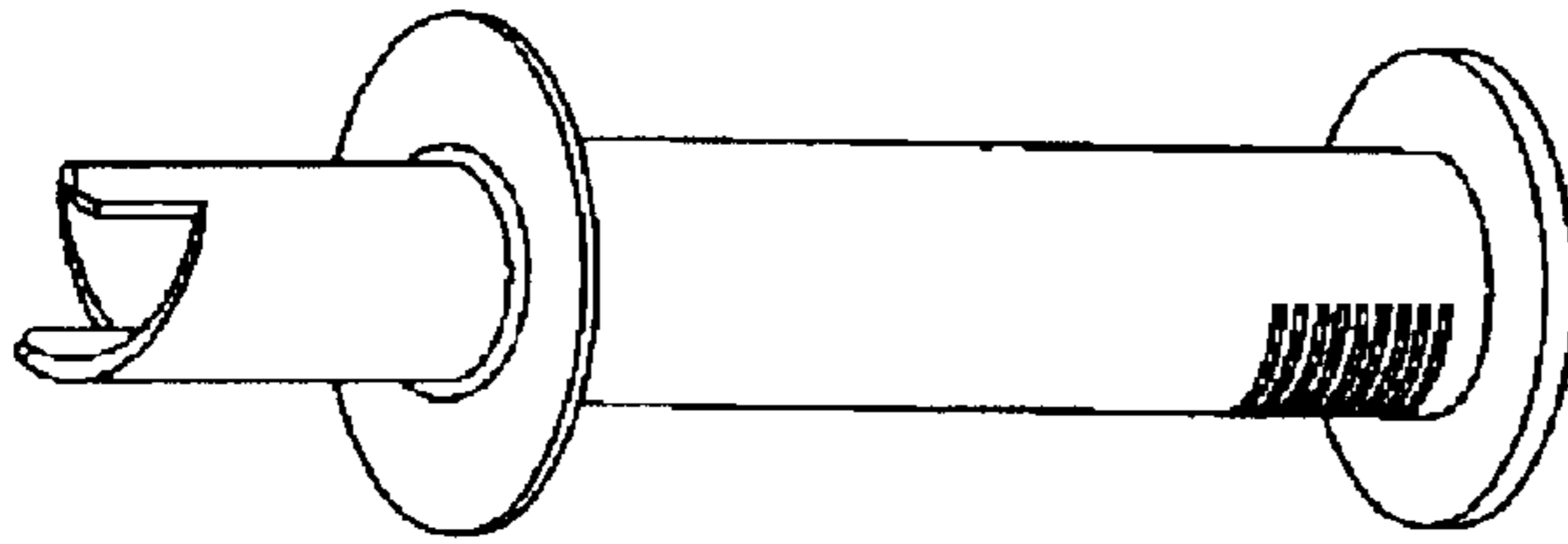

FIG. 11

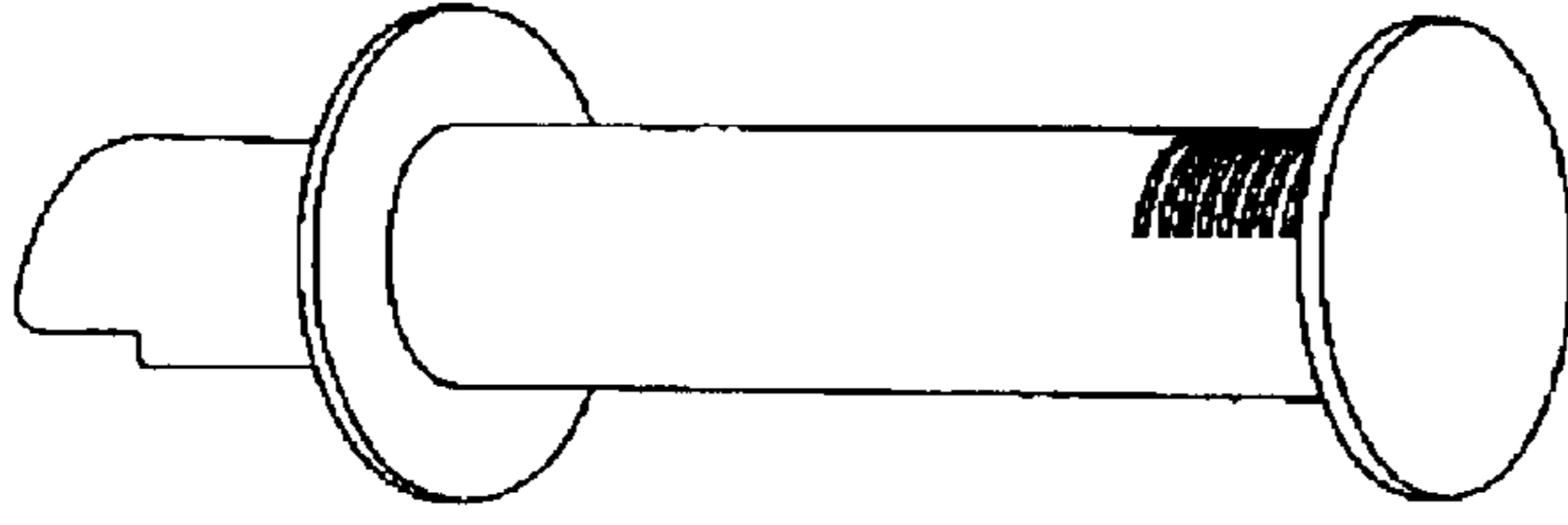

FIG. 12

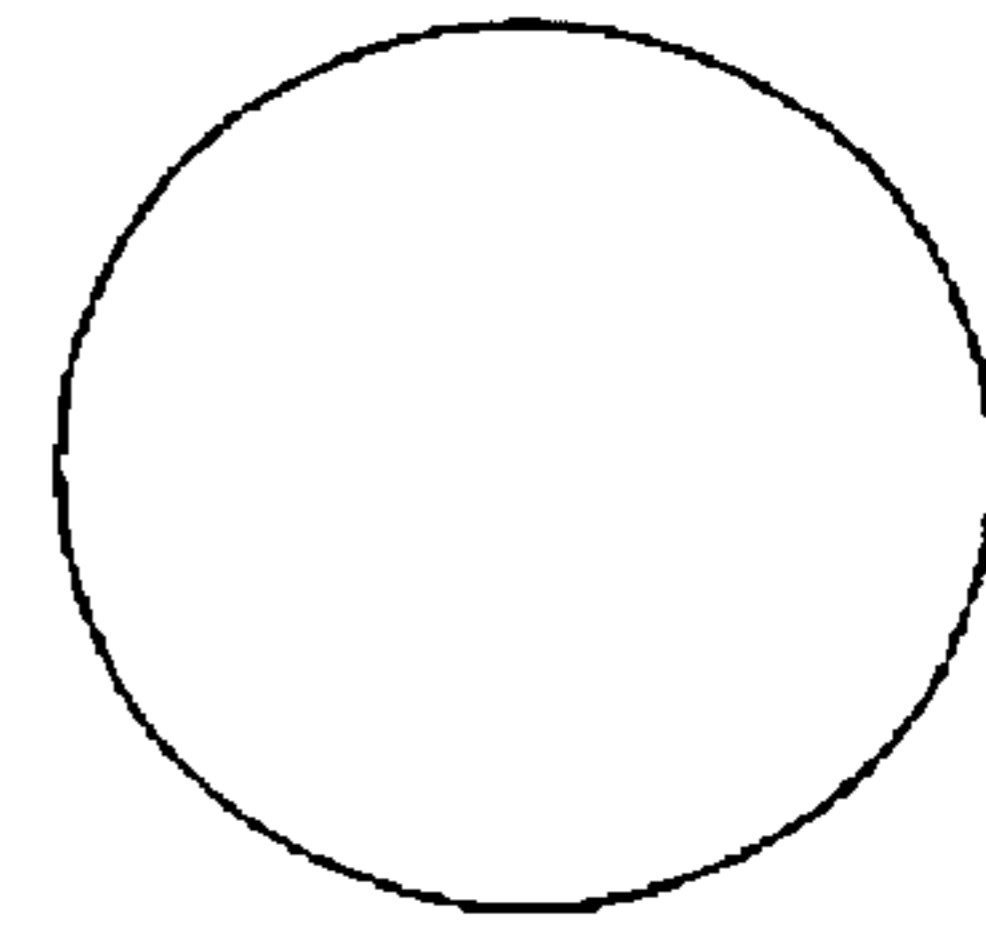

FIG. 13

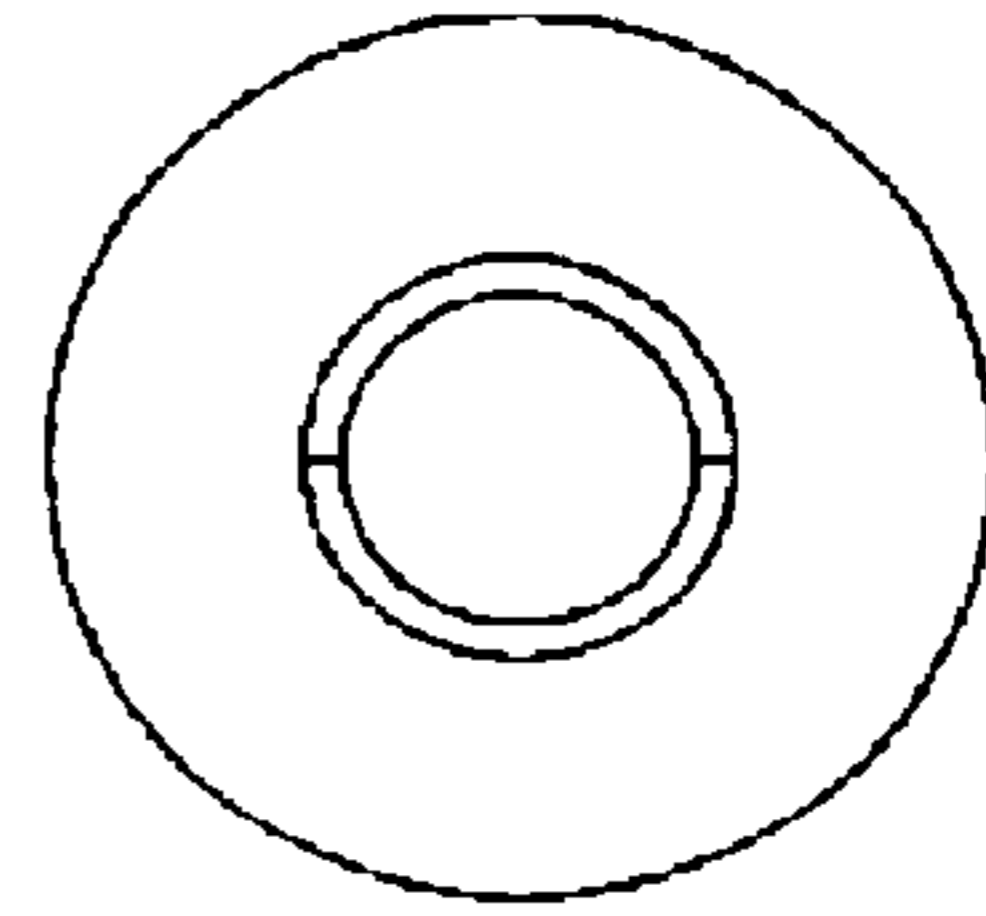

FIG. 14

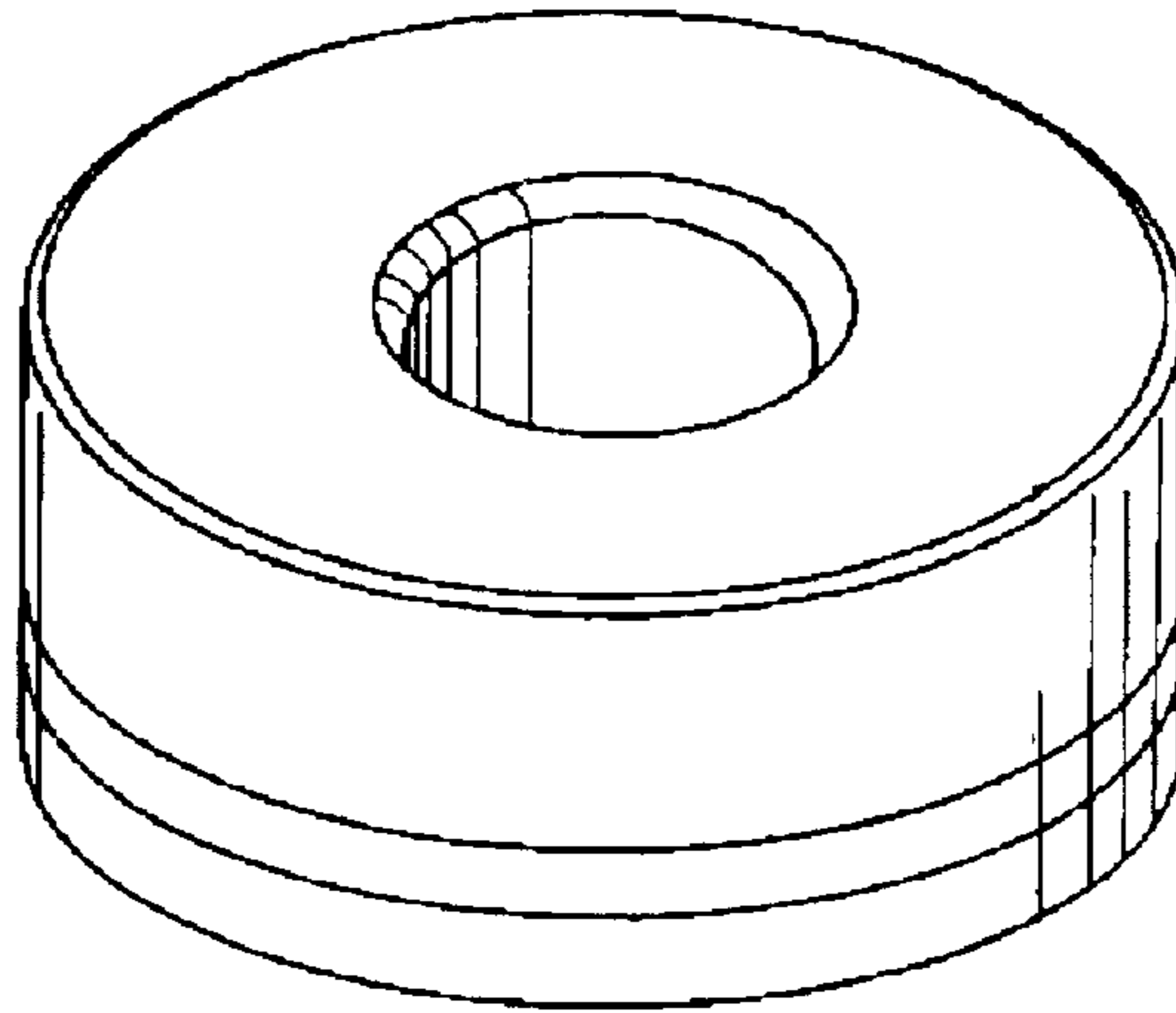

FIG. 15

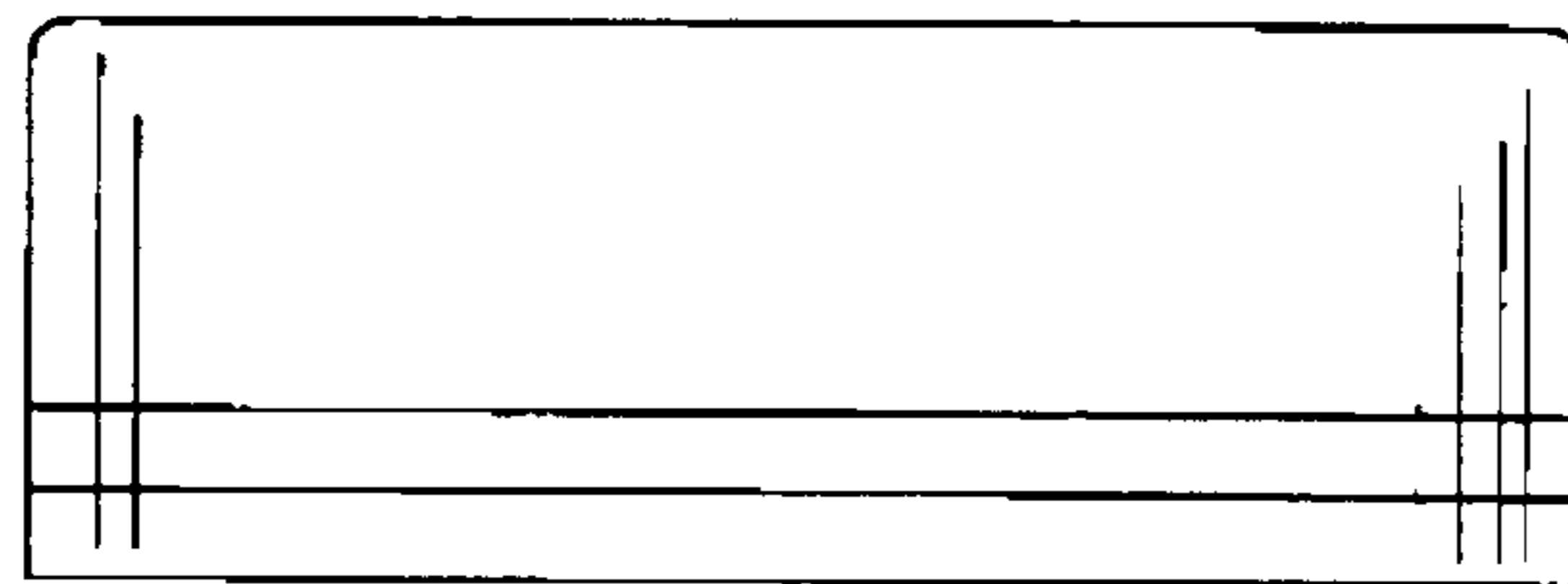

FIG. 16

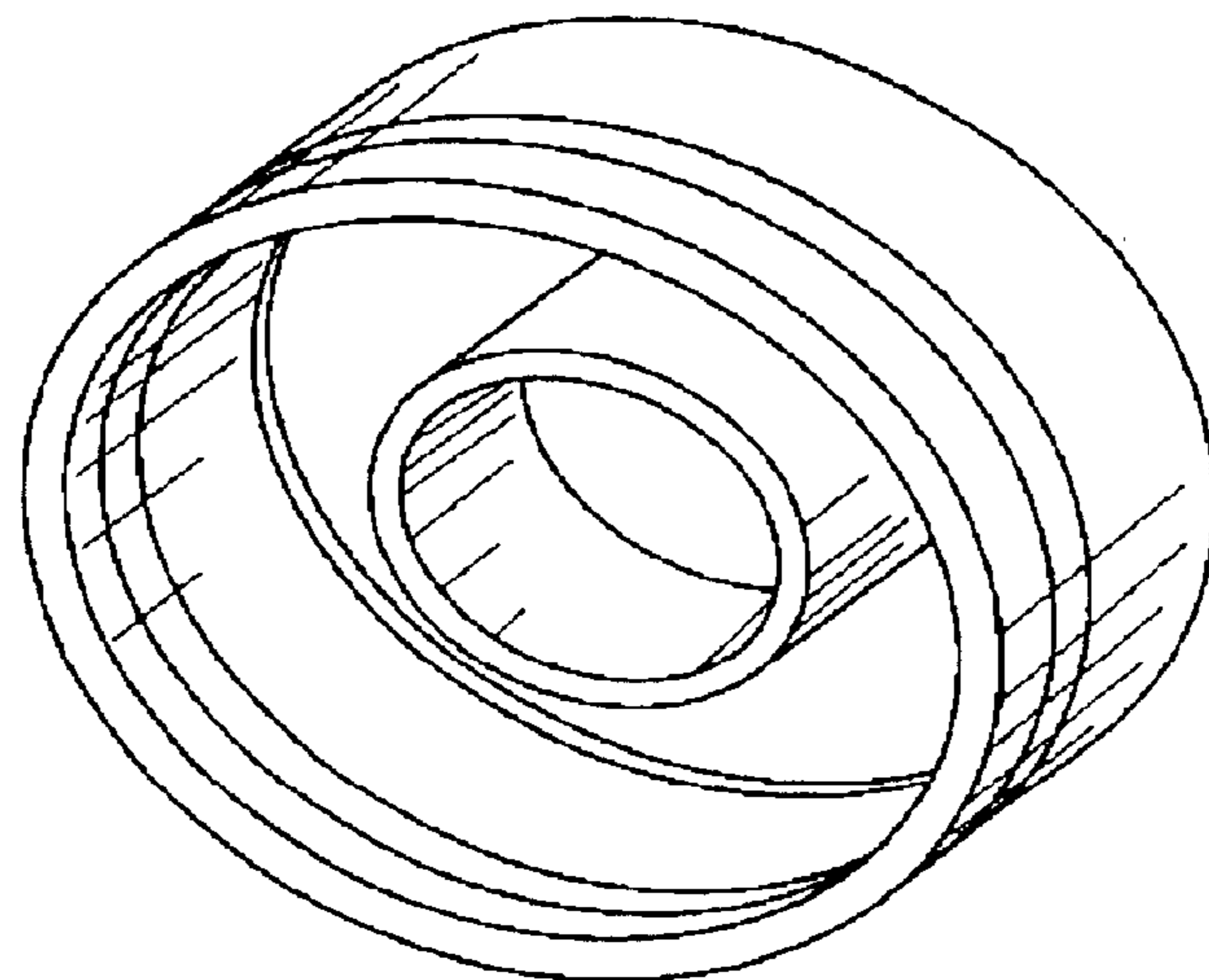

FIG. 17