



US00D520572S

(12) **United States Design Patent**
Balough

(10) **Patent No.:** **US D520,572 S**

(45) **Date of Patent:** **** May 9, 2006**

(54) **GIRAFFE ROCKER**

(76) **Inventor:** **Floyd Balough**, 1915 E. Florida St.,
Long Beach, CA (US) 90802

(**) **Term:** **14 Years**

(21) **Appl. No.:** **29/197,709**

(22) **Filed:** **Jan. 20, 2004**

(51) **LOC (8) Cl.** **21-01**

(52) **U.S. Cl.** **D21/415**

(58) **Field of Classification Search** D21/412-419,
D21/427, 428, 825, 828, 831, 832; D6/345,
D6/351, 359; 472/95-105, 114, 135; 297/181;
446/29

See application file for complete search history.

(56) **References Cited**

U.S. PATENT DOCUMENTS

- D65,717 S * 10/1924 Agell D21/417
- D117,553 S * 11/1939 Bojensen D21/417
- D137,971 S * 5/1944 Hartwig D21/417

- D159,796 S * 8/1950 Ganine D21/415
- D176,016 S * 11/1955 Hawkins D21/417
- D243,545 S * 3/1977 Seegers, Sr. D21/417
- D258,303 S * 2/1981 Nakao et al. D21/428
- D287,899 S * 1/1987 Lindheimer D99/30

* cited by examiner

Primary Examiner—Catherine Tuttle

(74) *Attorney, Agent, or Firm*—Marcia A. Devon

(57) **CLAIM**

The ornamental design for a giraffe rocker, as shown and described.

DESCRIPTION

FIG. 1 is a perspective view showing my invention;
FIG. 2 is a front view thereof;
FIG. 3 is a rear view thereof;
FIG. 4 is a side view thereof;
FIG. 5 is a bottom plan view thereof; and,
FIG. 6 is a top plan view thereof.

1 Claim, 4 Drawing Sheets

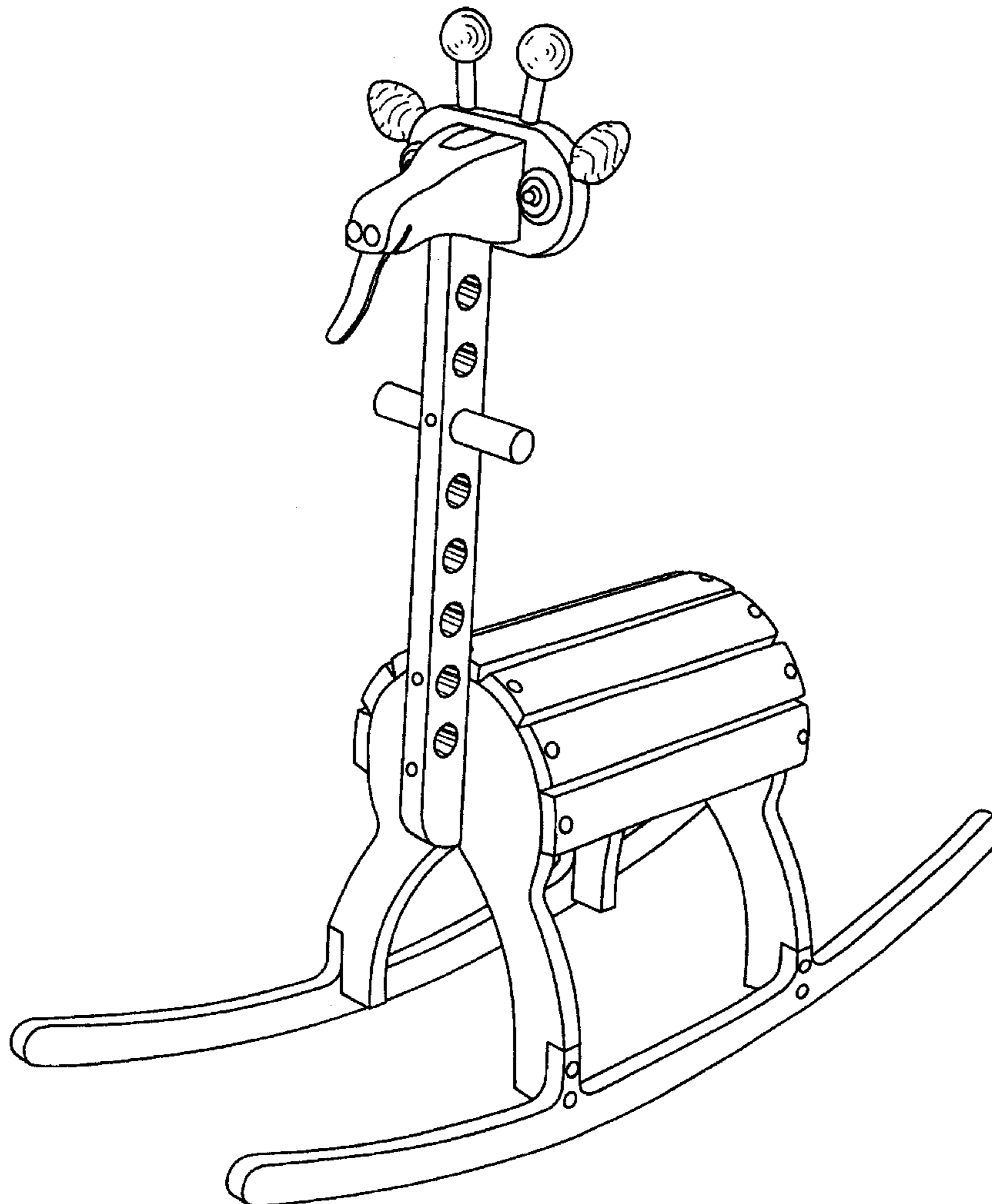

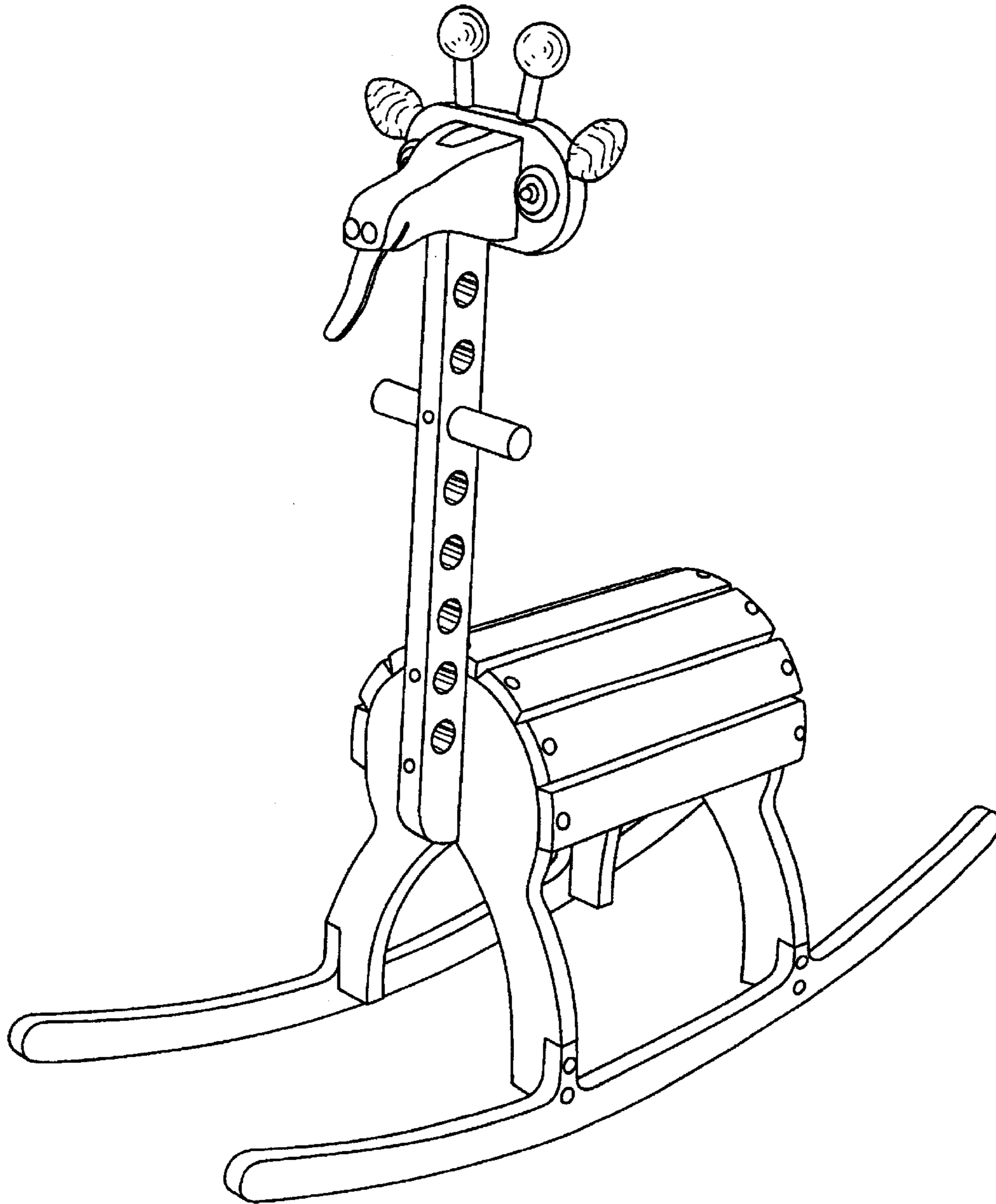

FIG. 1

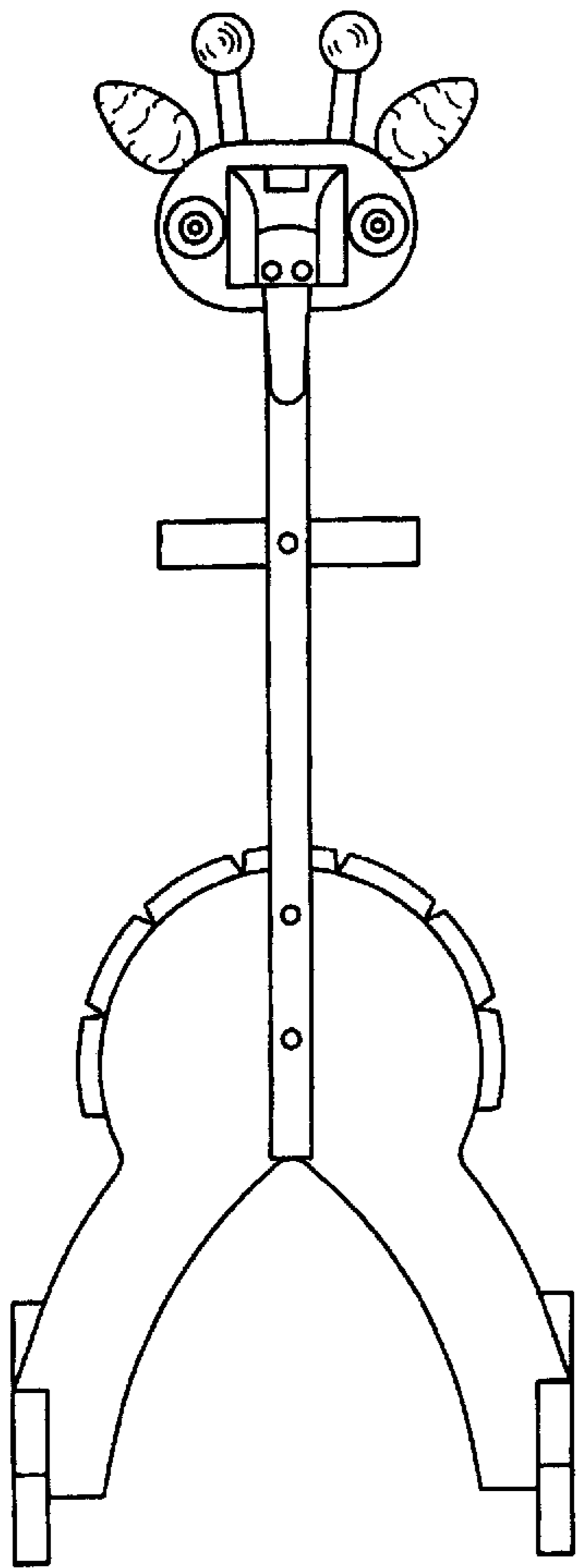

FIG. 2

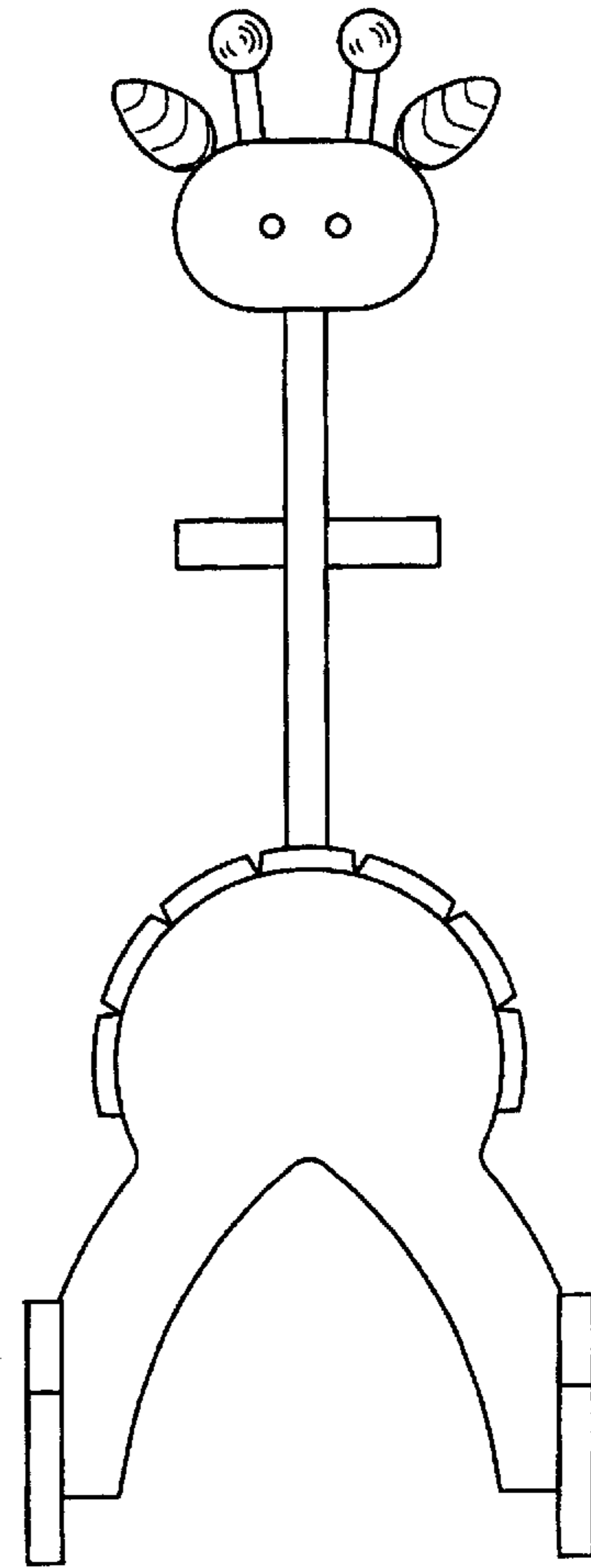

FIG. 3

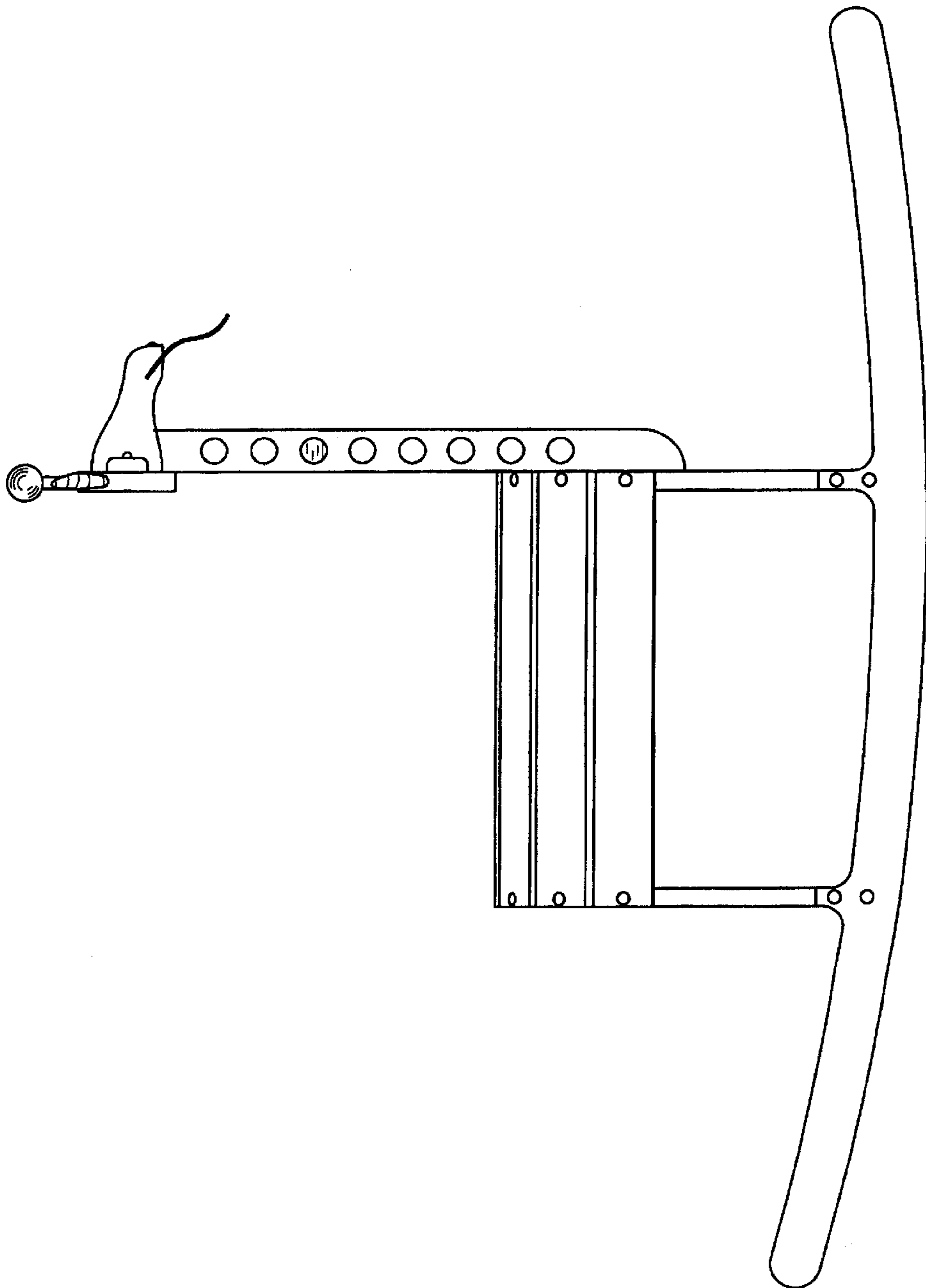

FIG. 4

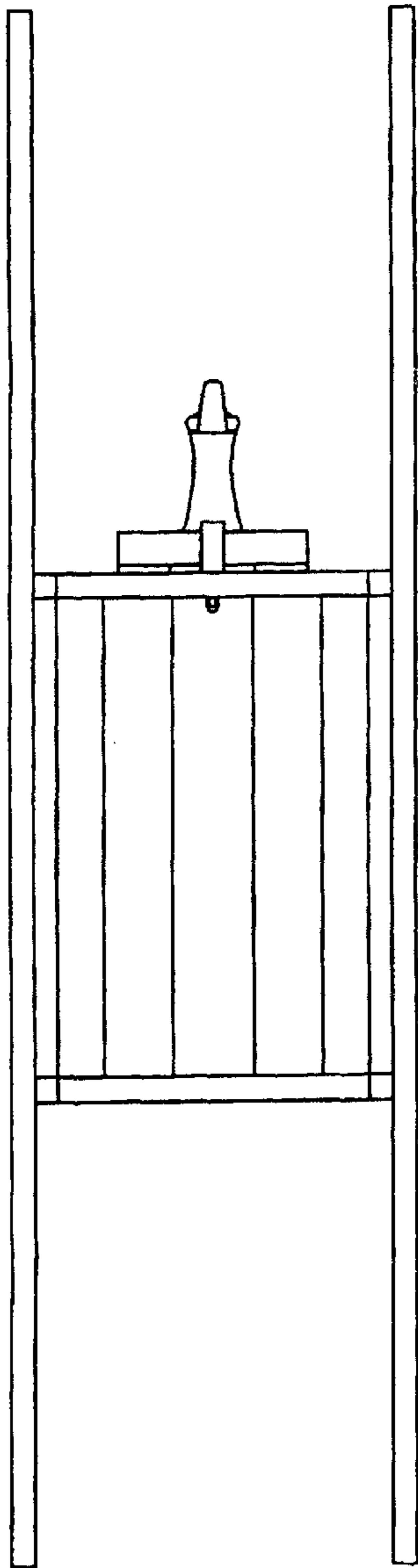

FIG. 5

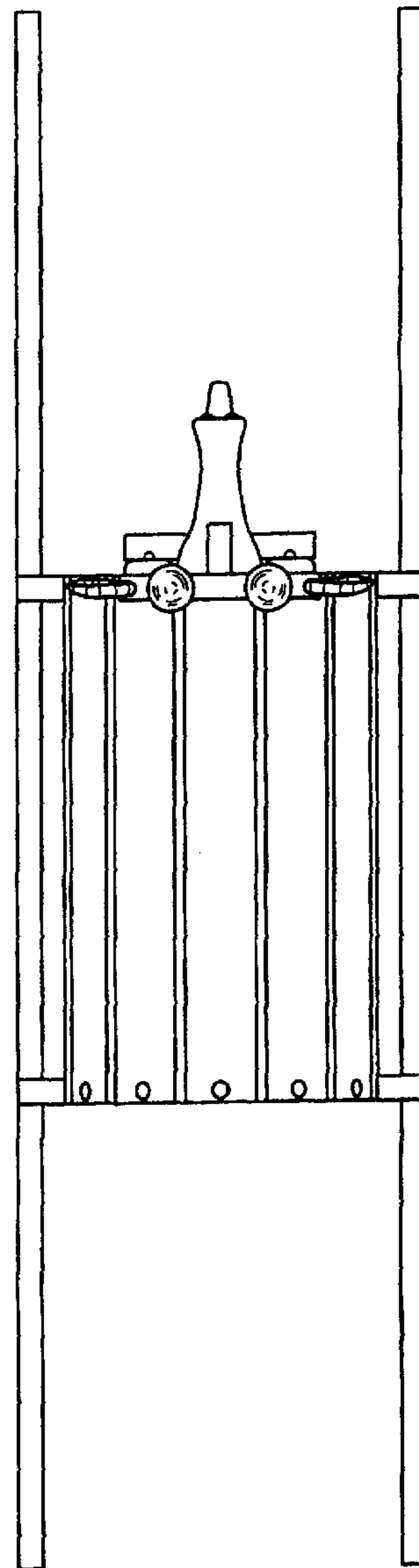

FIG. 6