



US00D520469S

(12) **United States Design Patent**  
**Lin**

(10) **Patent No.:** **US D520,469 S**  
(45) **Date of Patent:** **\*\* May 9, 2006**

(54) **TELEVISION SET**

(75) Inventor: **Roger Lin**, Taipei (TW)

(73) Assignee: **Hannspree, Inc.**, Taipei (TW)

(\*\*) Term: **14 Years**

(21) Appl. No.: **29/227,533**

(22) Filed: **Apr. 13, 2005**

(30) **Foreign Application Priority Data**

Dec. 3, 2004 (TW) ..... 093307313

(51) **LOC (8) Cl.** ..... **14-03**

(52) **U.S. Cl.** ..... **D14/126; D14/129**

(58) **Field of Classification Search** ..... D14/125-134,  
D14/239, 371, 136, 374-376; 312/7.2; 348/836,  
348/838, 180, 184, 325, 739; 341/12; 248/917-924,  
248/465; 345/104, 133, 156, 168, 87, 173;  
720/605, 669, 600, 655; 369/99, 197; 455/344-347  
See application file for complete search history.

(56) **References Cited**

**U.S. PATENT DOCUMENTS**

5,072,998 A \* 12/1991 Oh ..... 312/7.2  
D323,324 S \* 1/1992 Suda ..... D14/125  
5,464,214 A \* 11/1995 Griffin ..... 273/148 B  
5,564,209 A \* 10/1996 Zagnoli ..... 312/7.2  
5,825,347 A \* 10/1998 Prinsen ..... 348/836

D406,613 S \* 3/1999 Nakanishi ..... D21/329  
6,159,101 A \* 12/2000 Simpson ..... 463/46  
D438,849 S \* 3/2001 Adachi et al. .... D14/126  
6,558,225 B1 \* 5/2003 Rehkemper et al. .... 446/297  
D475,707 S \* 6/2003 Zuege et al. .... D14/371  
D500,099 S \* 12/2004 Gioffre ..... D21/627  
D508,695 S \* 8/2005 Vaughn ..... D14/448

**OTHER PUBLICATIONS**

Hong Kong Enterprise, p. 212, Feb. 2000.\*

\* cited by examiner

*Primary Examiner*—Raphael Barkai

(74) *Attorney, Agent, or Firm*—Troxell Law Office, PLLC

(57) **CLAIM**

The ornamental design for a television set, as shown and described.

**DESCRIPTION**

FIG. 1 is a perspective view of television set showing my design;  
FIG. 2 is another perspective view thereof;  
FIG. 3 is a front view thereof;  
FIG. 4 is a right side view thereof;  
FIG. 5 is a top view thereof;  
FIG. 6 is a rear view thereof; and,  
FIG. 7 is a left side view thereof.

**1 Claim, 4 Drawing Sheets**

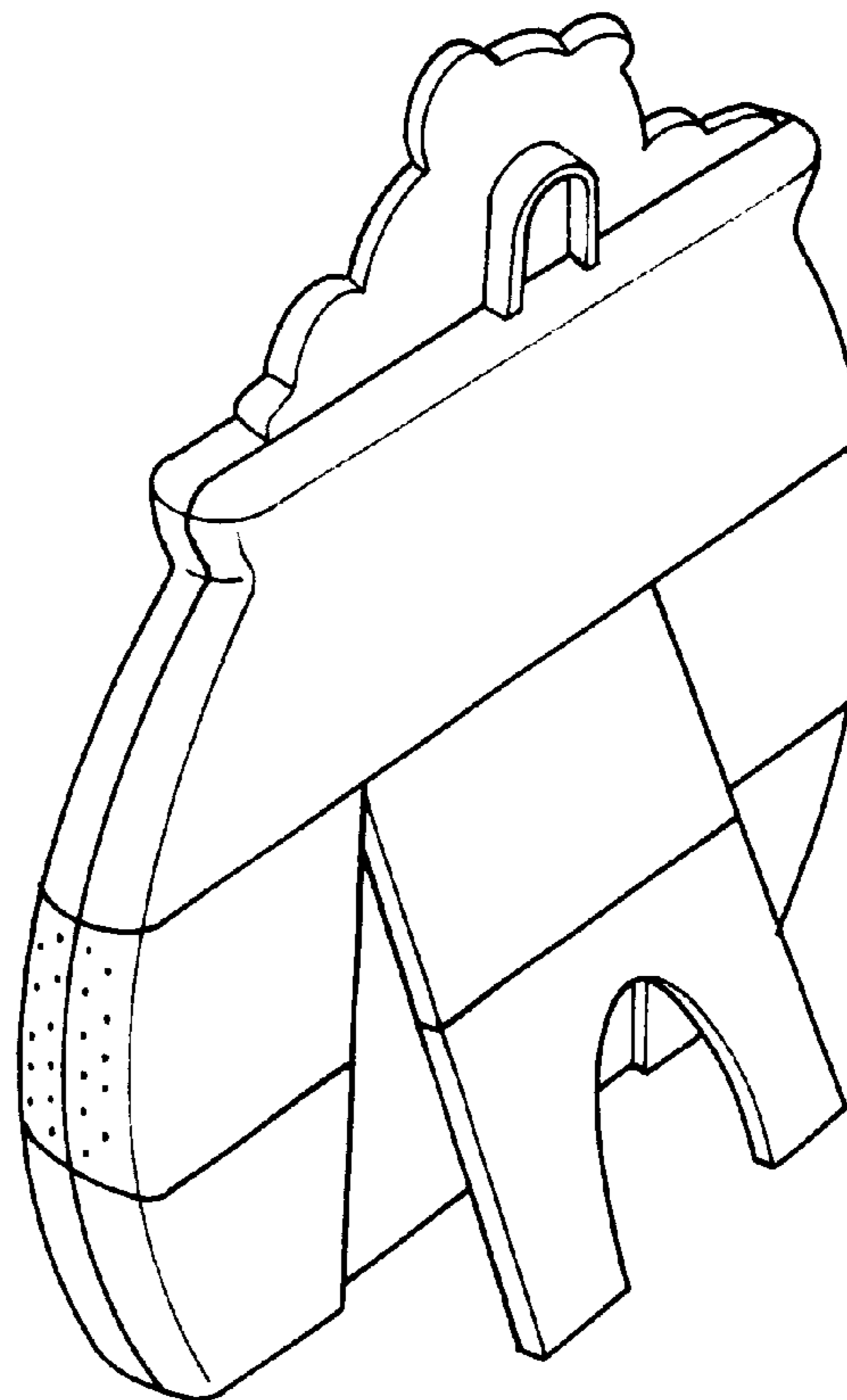
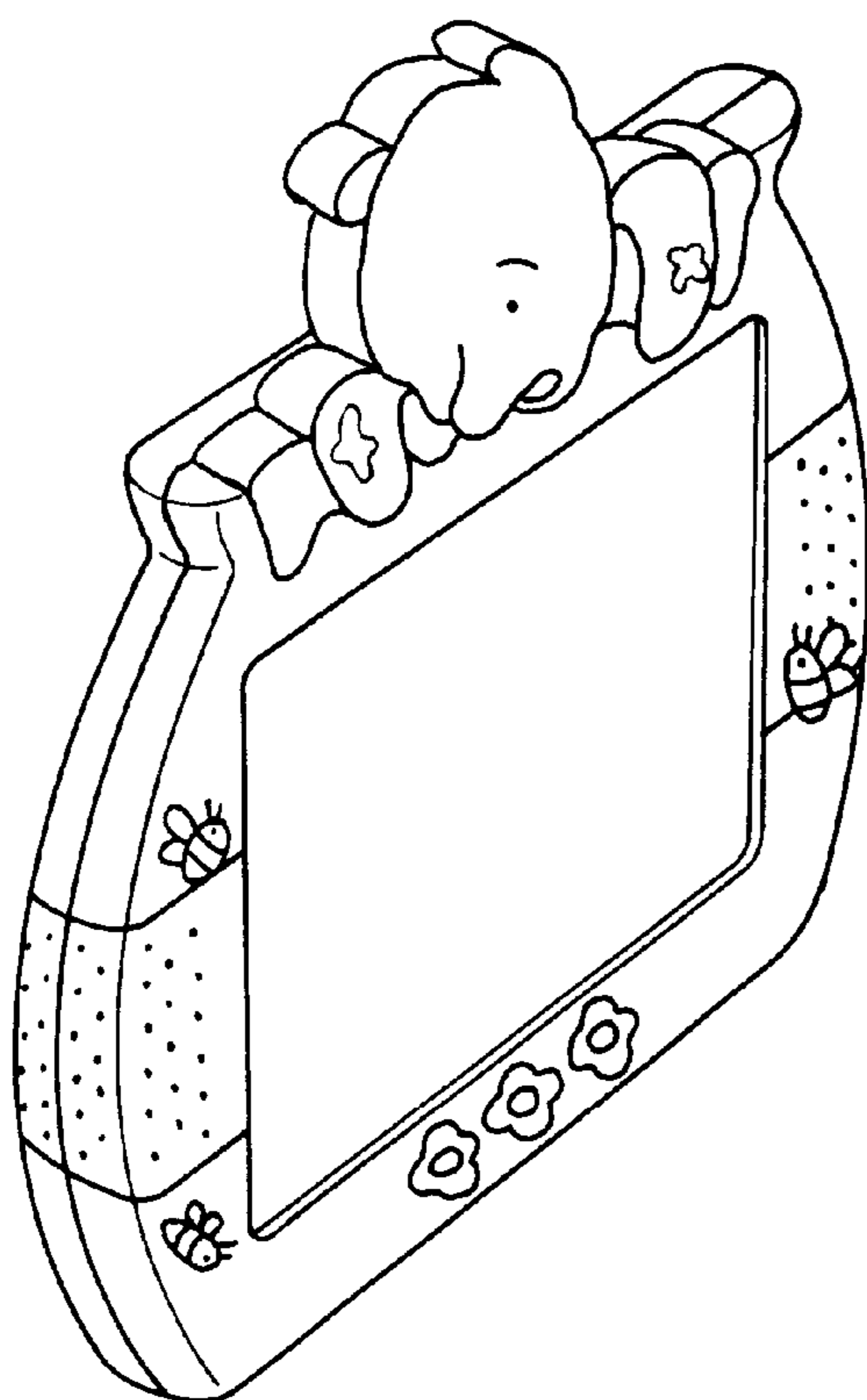

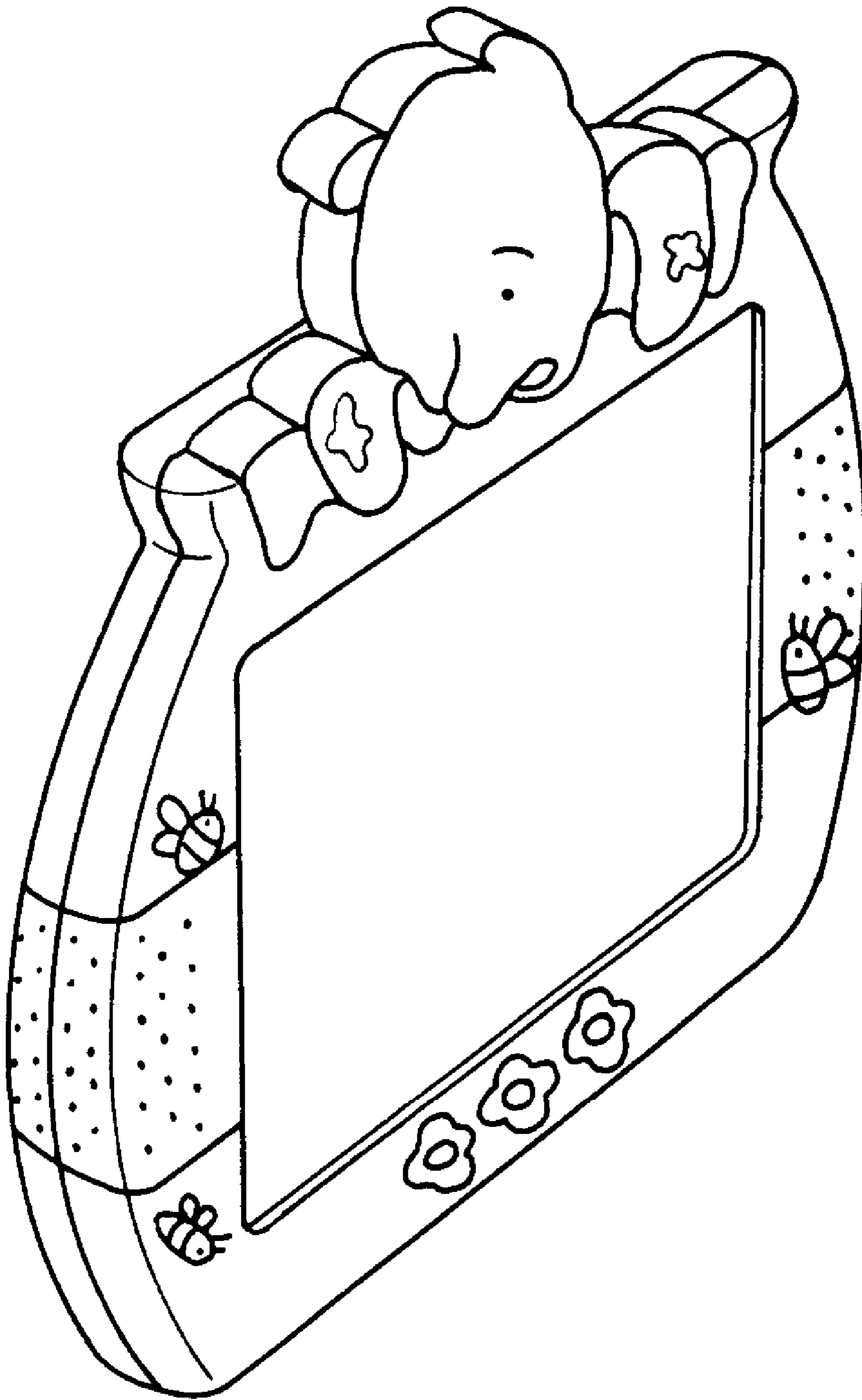

FIG. 1

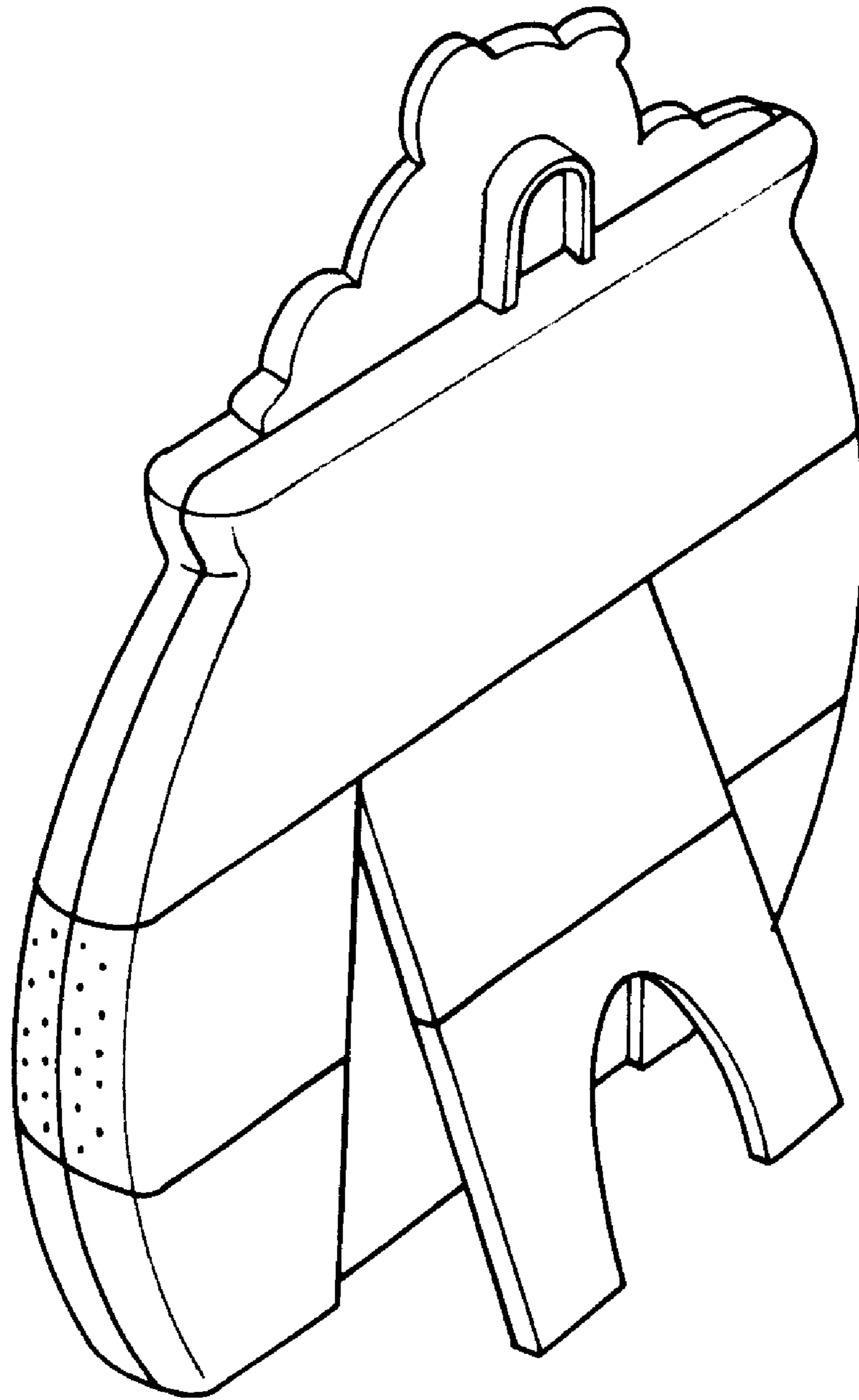

FIG. 2

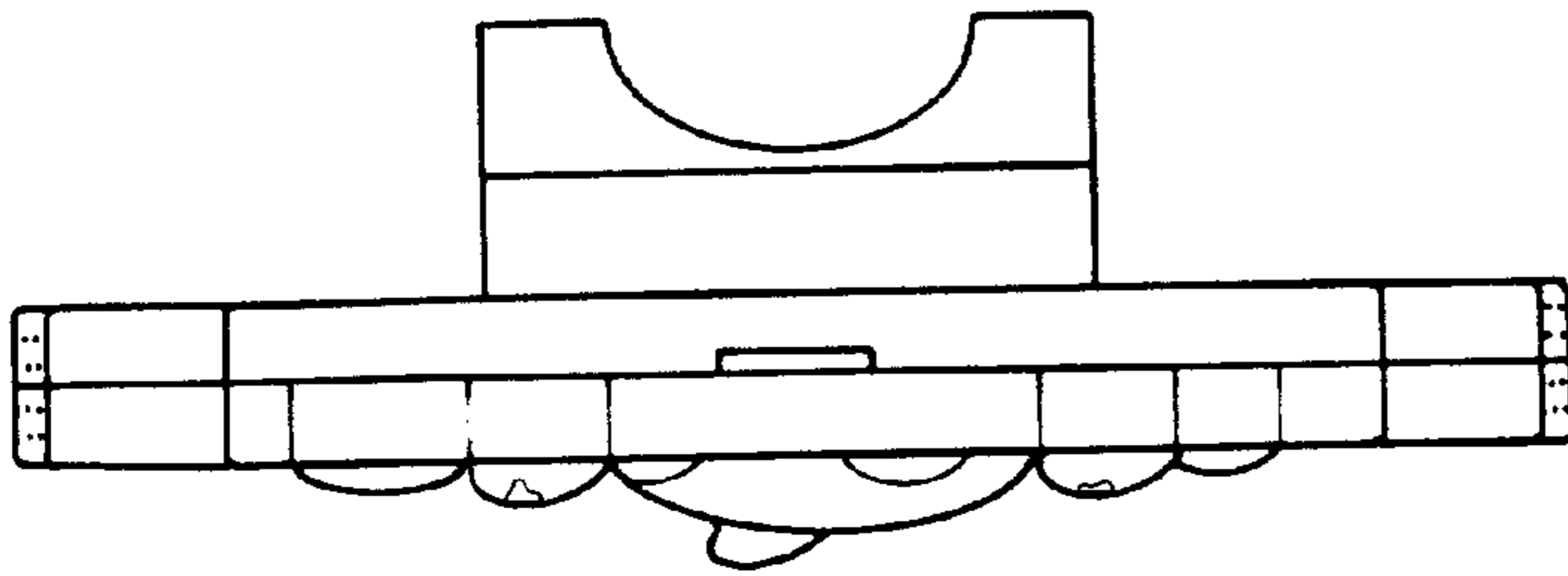

FIG. 5

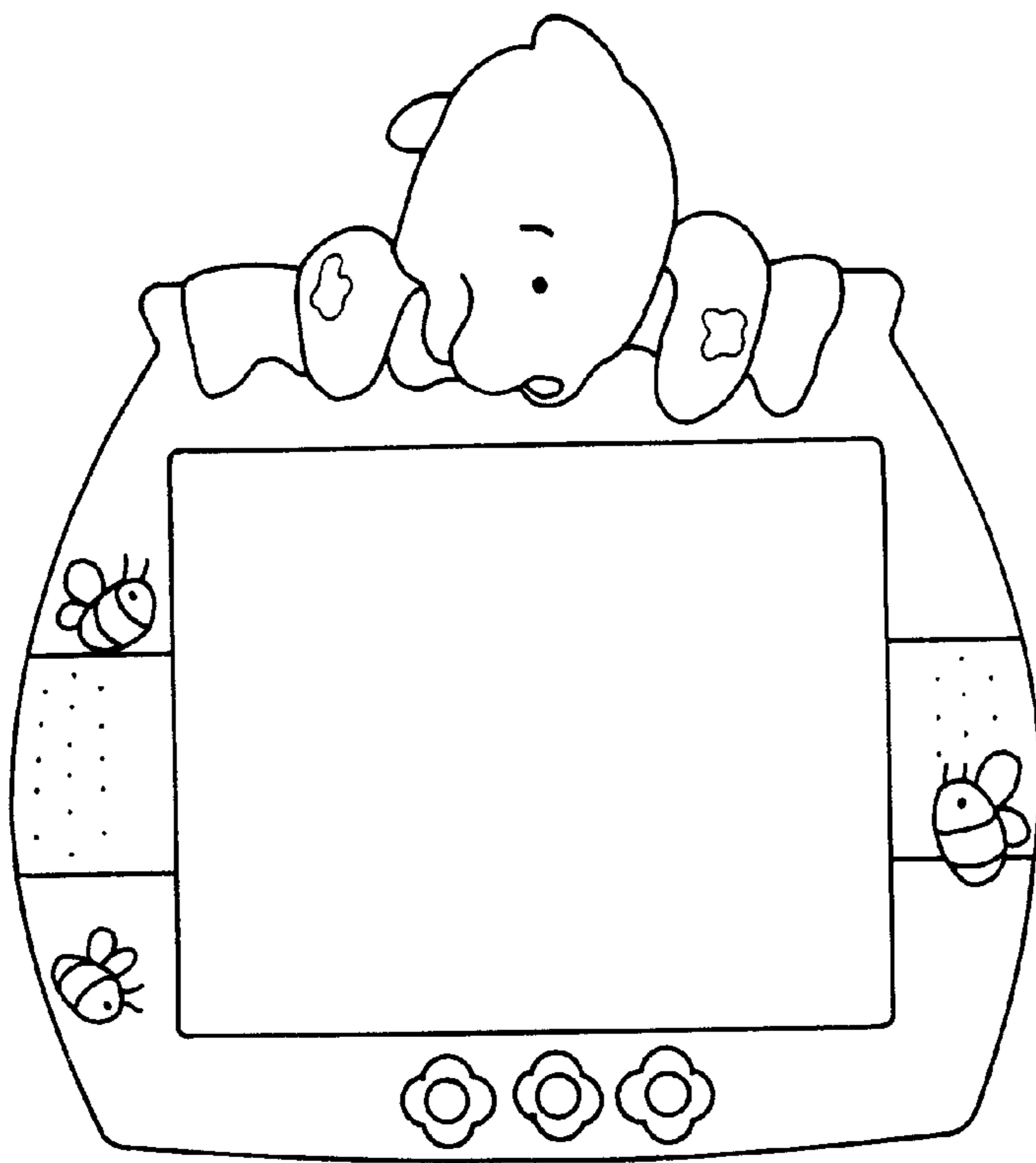

FIG. 3

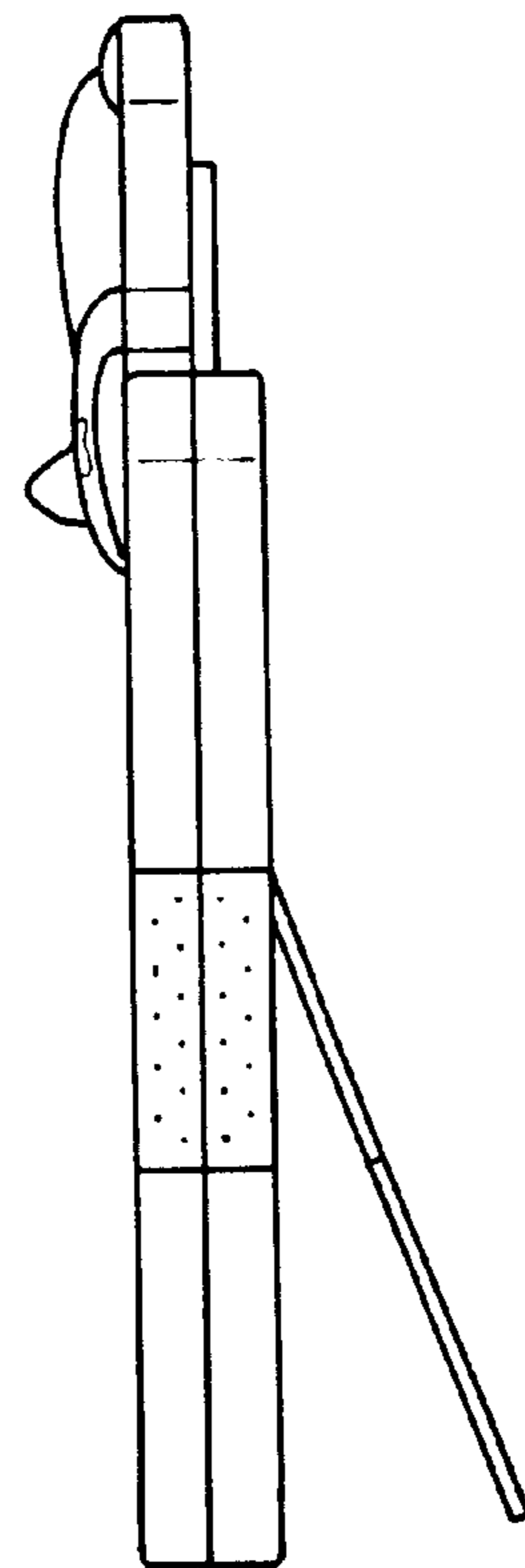

FIG. 4

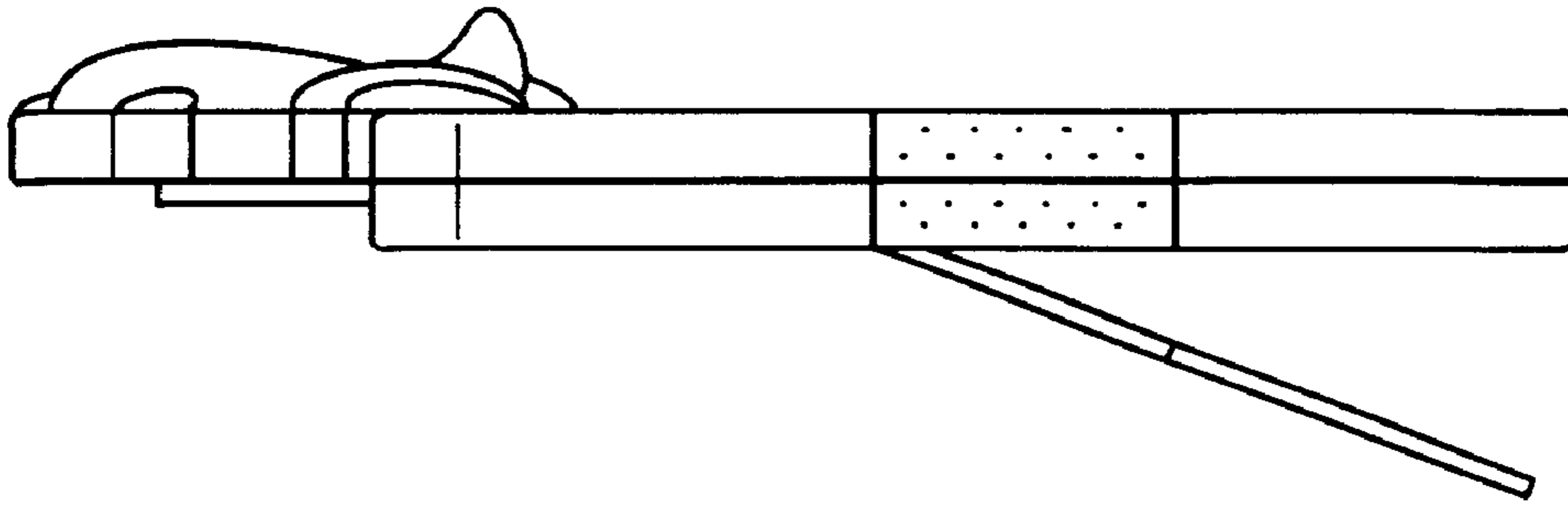

FIG. 7

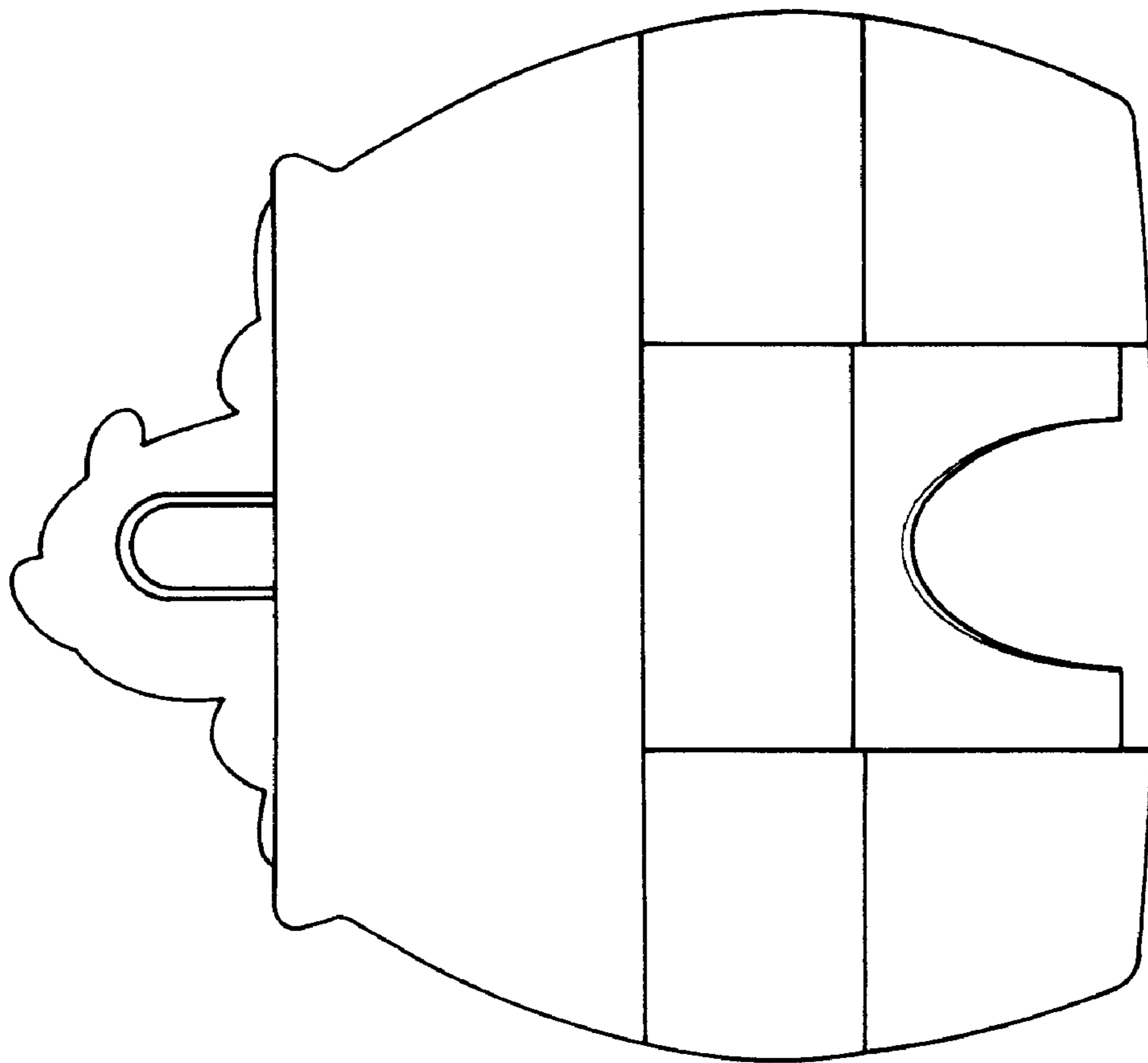

FIG. 6