



US00D520395S

(12) **United States Design Patent**
Lazalier

(10) **Patent No.:** **US D520,395 S**

(45) **Date of Patent:** **** May 9, 2006**

(54) **THREE-SIDED LED LIGHT**

(76) Inventor: **Ray Melton Lazalier**, 903 Ampere Pl.,
Lake St. Louis, MO (US) 63367

(**) Term: **14 Years**

(21) Appl. No.: **29/225,088**

(22) Filed: **Mar. 10, 2005**

(51) **LOC (8) Cl.** **10-05**

(52) **U.S. Cl.** **D10/114**

(58) **Field of Classification Search** D10/109,
D10/114, 121; 116/63 P, 63 C, 63 T; 340/471,
340/472, 473

See application file for complete search history.

(56) **References Cited**

U.S. PATENT DOCUMENTS

D340,001 S	*	10/1993	Watkins	D10/114
D349,467 S	*	8/1994	Halaby	D10/114
D391,881 S	*	3/1998	Youseph	D10/114
D425,812 S	*	5/2000	Bodo	D10/114
D471,833 S	*	3/2003	Jacober et al.	D10/114
D498,164 S	*	11/2004	Delich	D10/114

* cited by examiner

Primary Examiner—Marcus A. Jackson

(74) *Attorney, Agent, or Firm*—Senniger Powers

(57) **CLAIM**

The ornamental design for a three-sided LED light, as shown and described.

DESCRIPTION

FIG. 1 is a perspective view of one preferred embodiment of a three-sided LED light incorporating my design; FIG. 2 is a front elevational view of the light of FIG. 1; FIG. 3 is a rear elevational view of the light of FIG. 1; FIG. 4 is a top plan view of the light of FIG. 1; FIG. 5 is a bottom plan view of the light of FIG. 1; FIG. 6 is a right side elevational view of the light of FIG. 1, the left side elevational view being a mirror image of the right side elevational view; FIG. 7 is a perspective view of another preferred embodiment of a three-sided LED light incorporating my design; FIG. 8 is a front elevational view of the light of FIG. 7; FIG. 9 is a rear elevational view of the light of FIG. 7; FIG. 10 is a top plan view of the light of FIG. 7; FIG. 11 is a bottom plan view of the light of FIG. 7; and, FIG. 12 is a right elevational view of the light of FIG. 7, the left side elevational view being a mirror image of the right side elevational view.

1 Claim, 6 Drawing Sheets

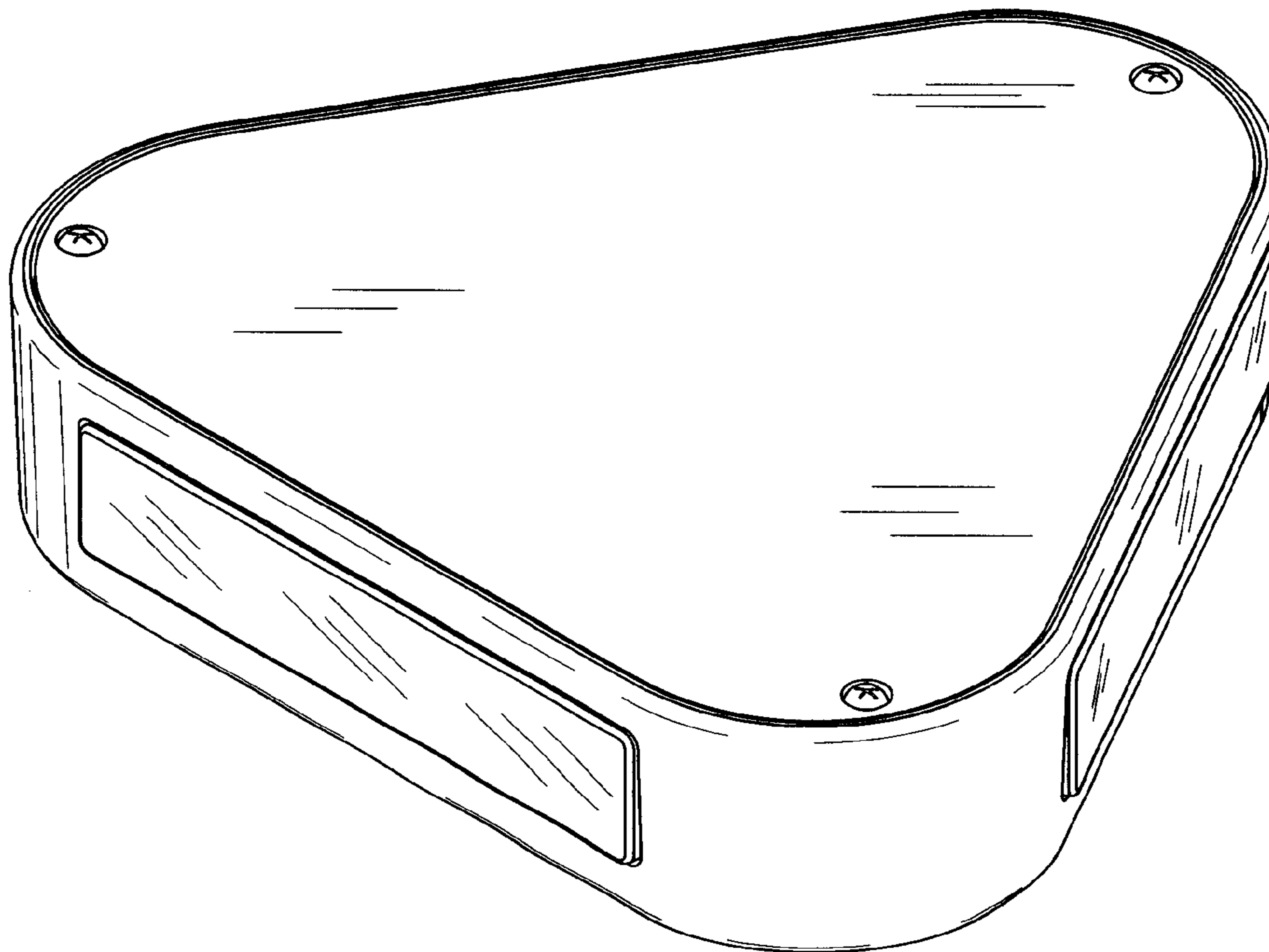

FIG. 1

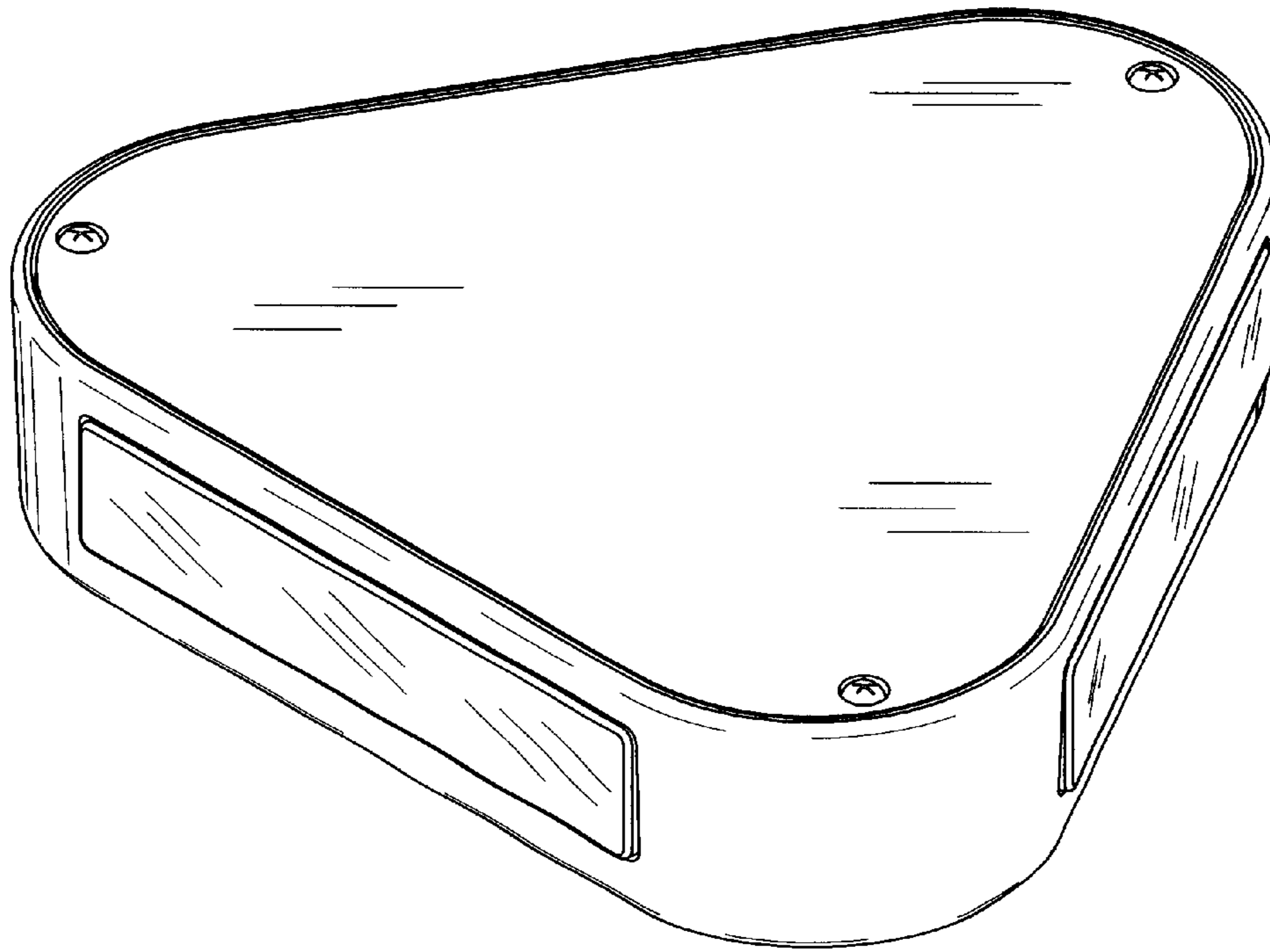

FIG. 2

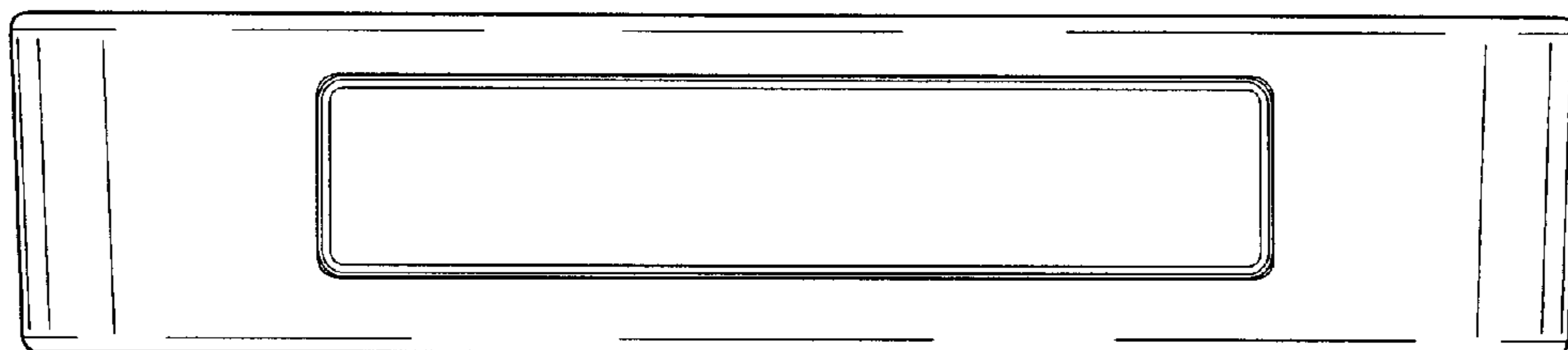

FIG. 3

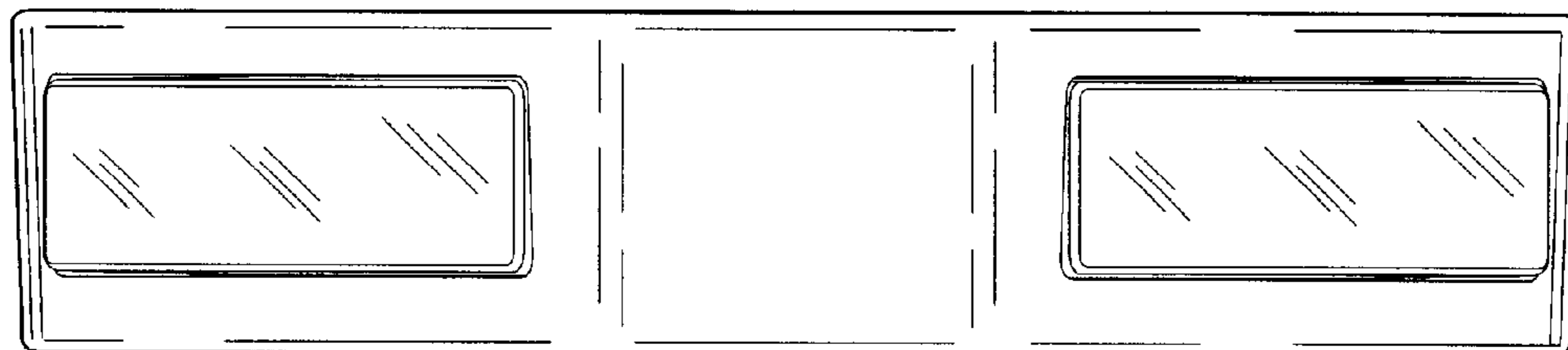

FIG. 4

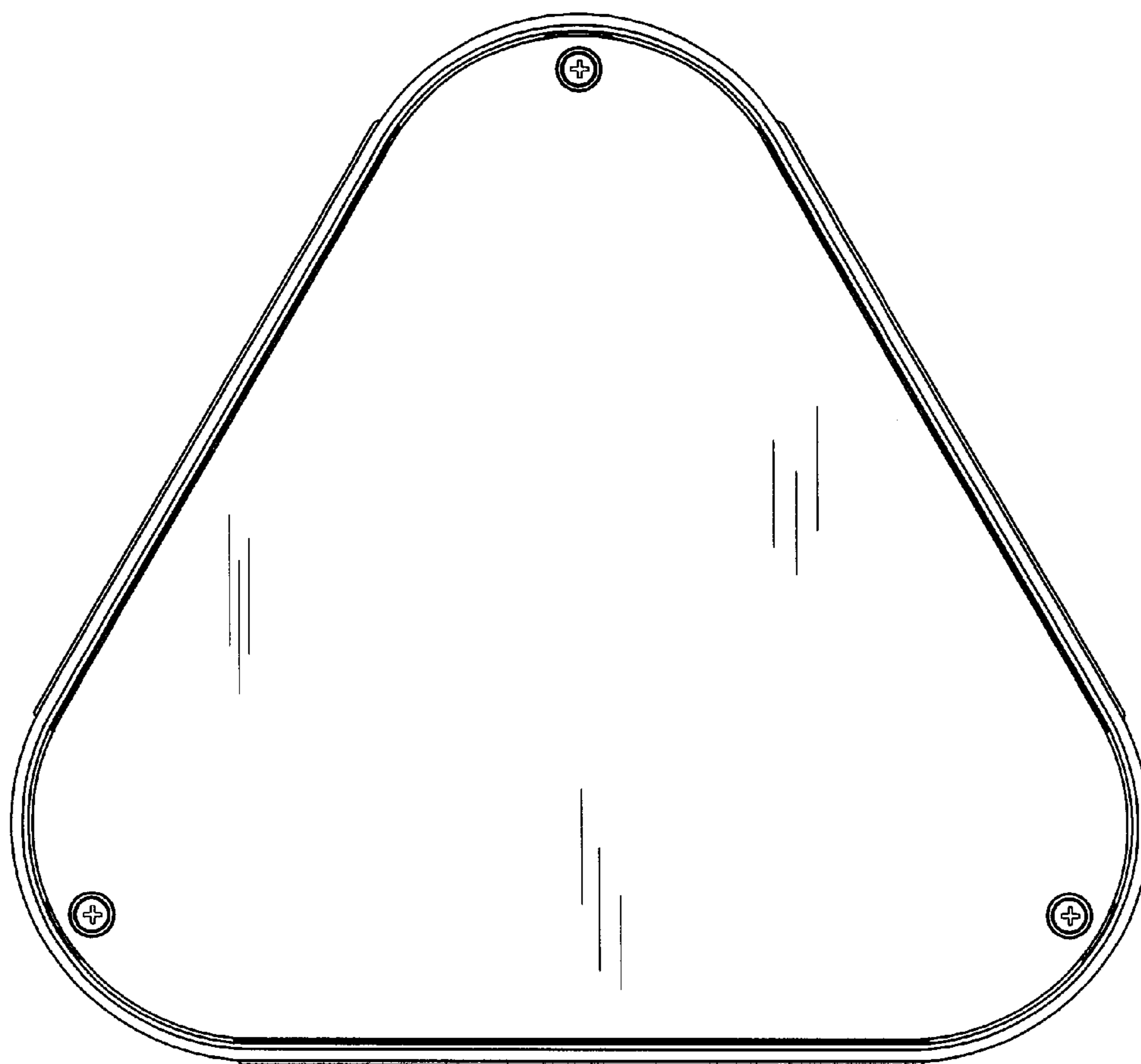

FIG. 5

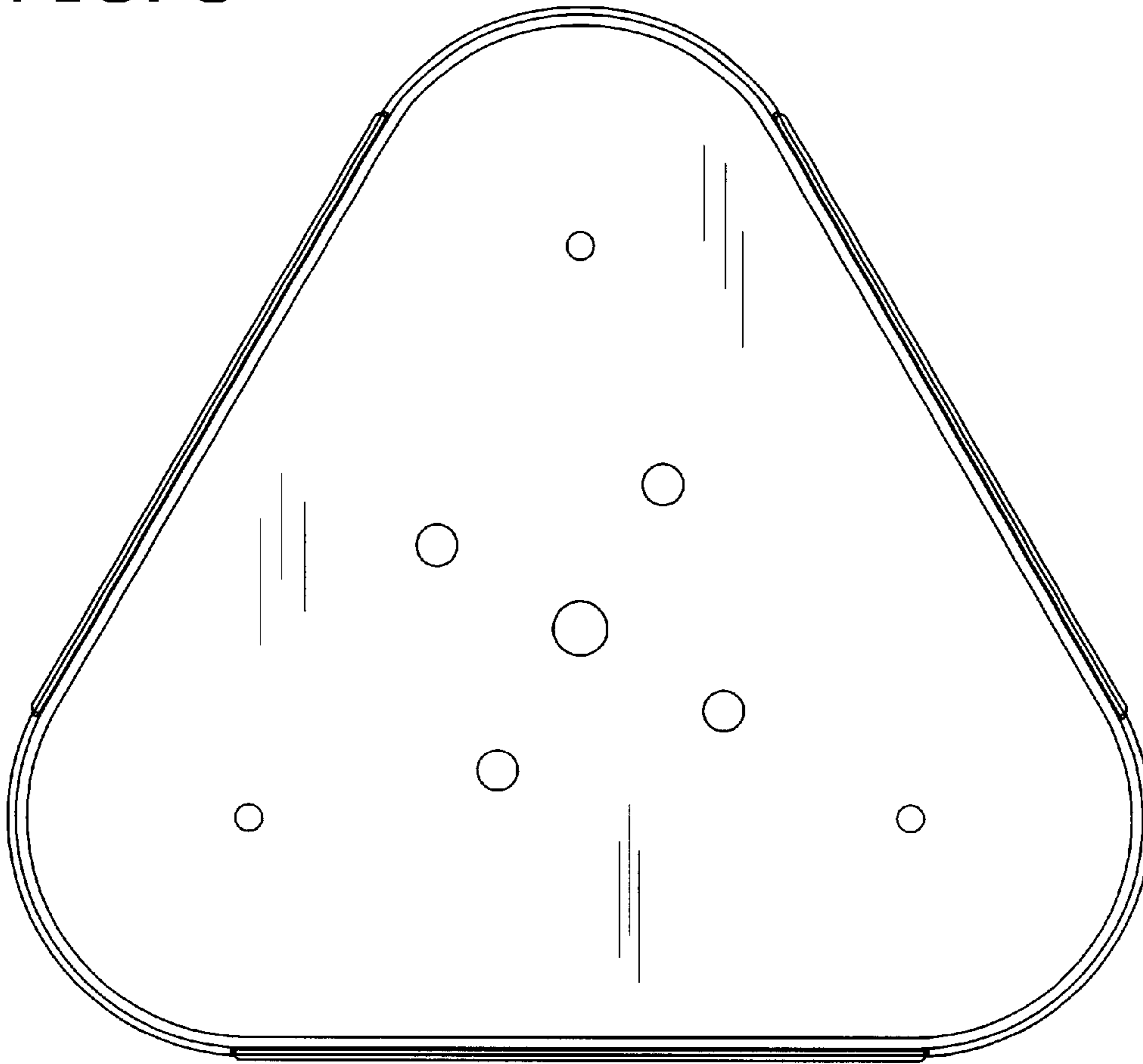

FIG. 6

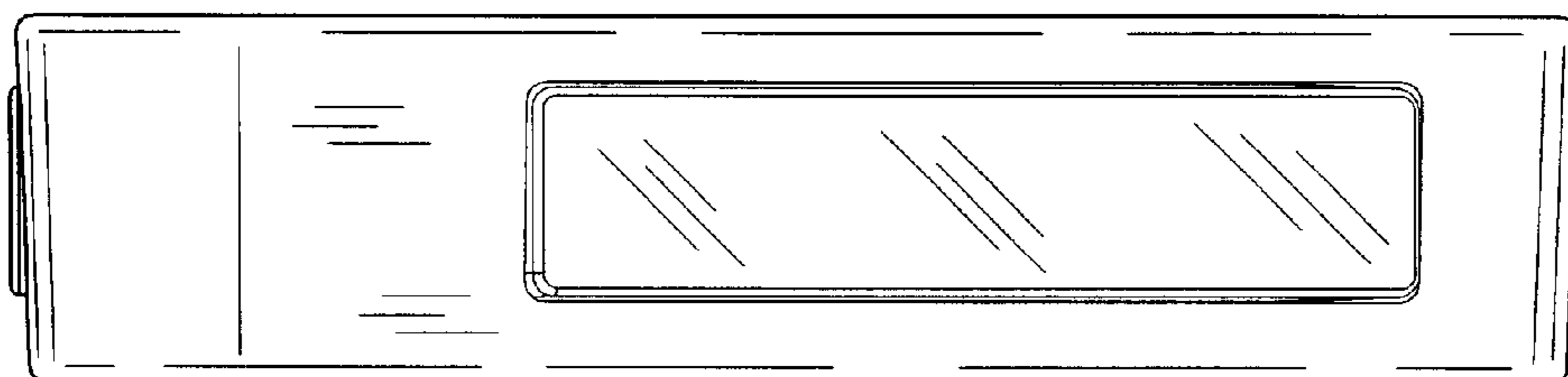

FIG. 7

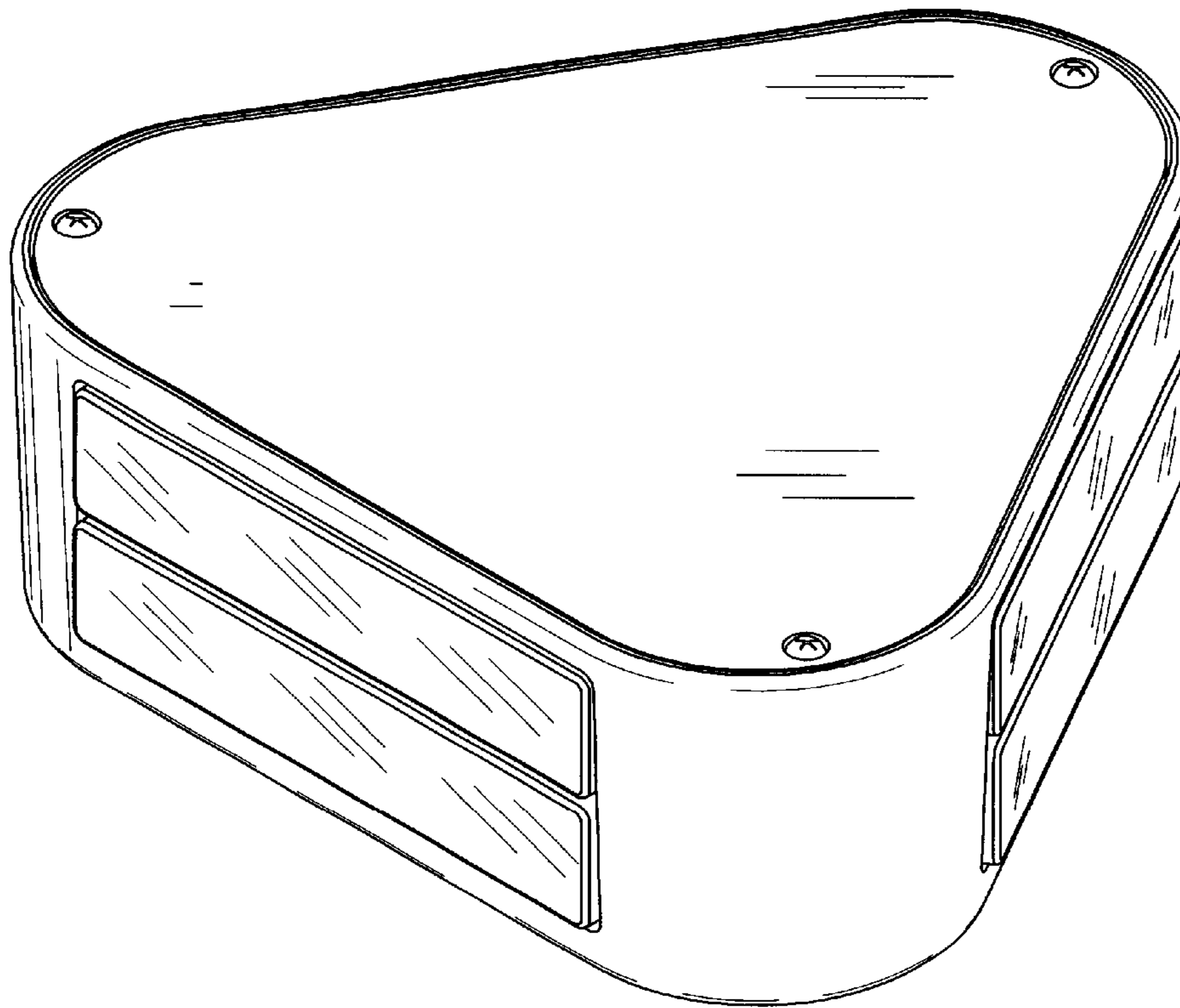

FIG. 8

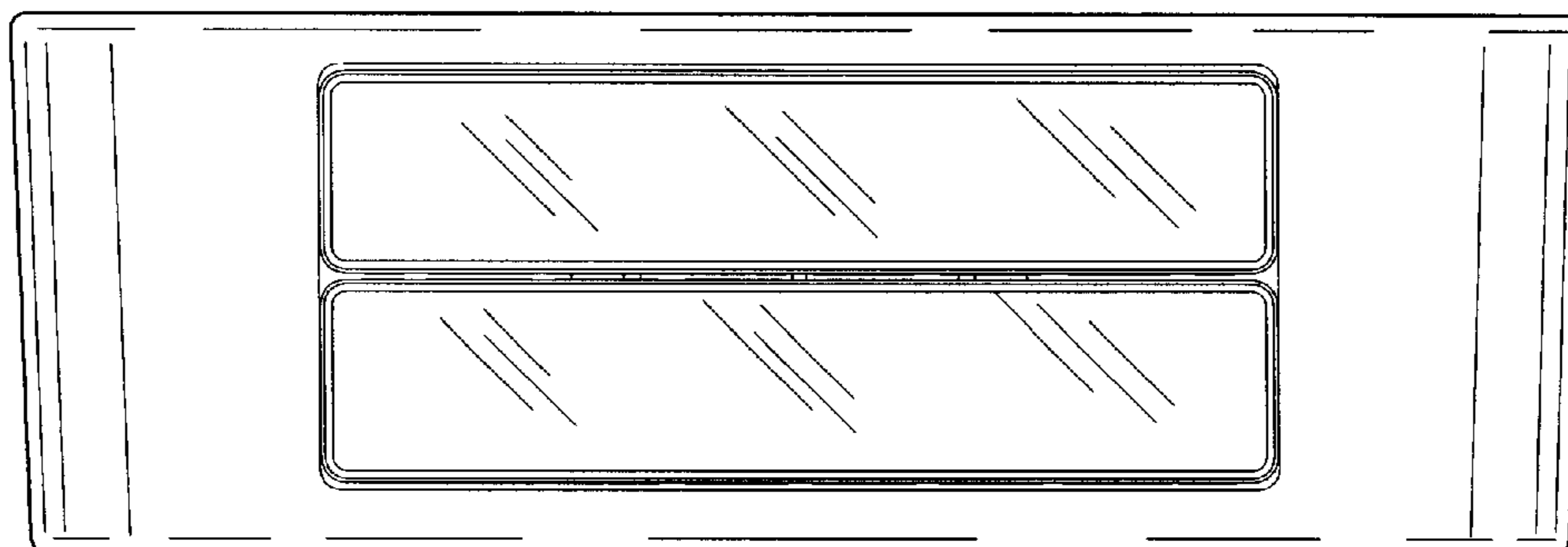

FIG. 9

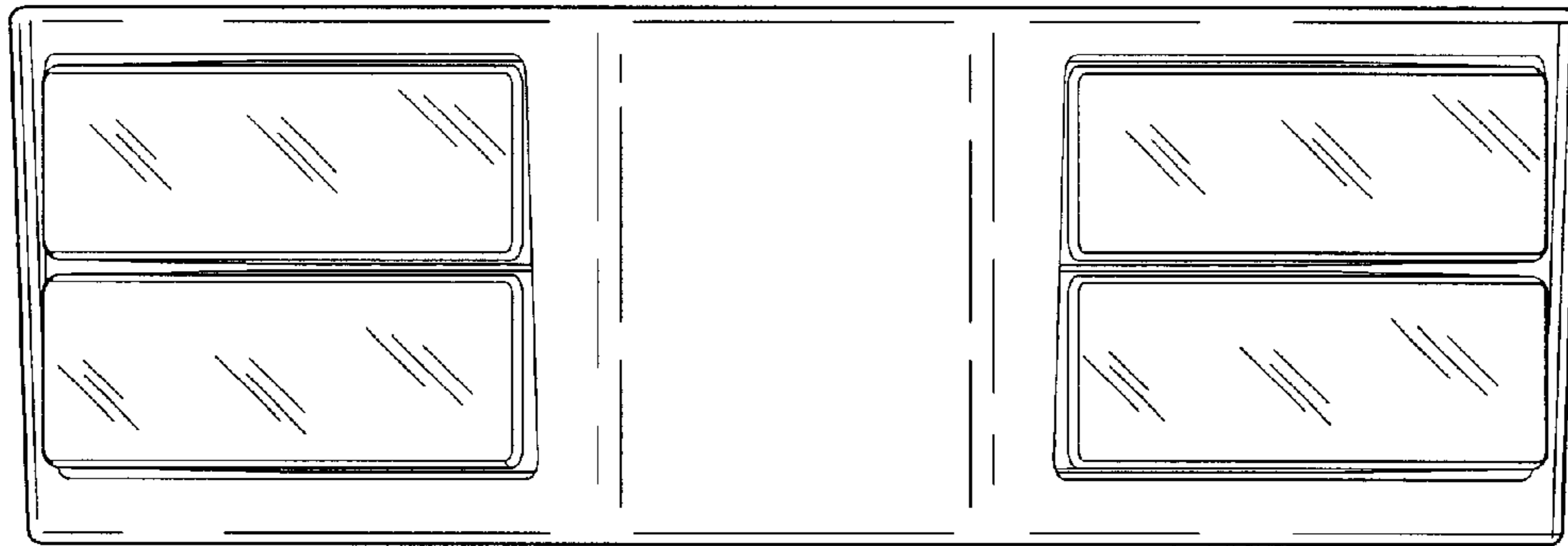

FIG. 10

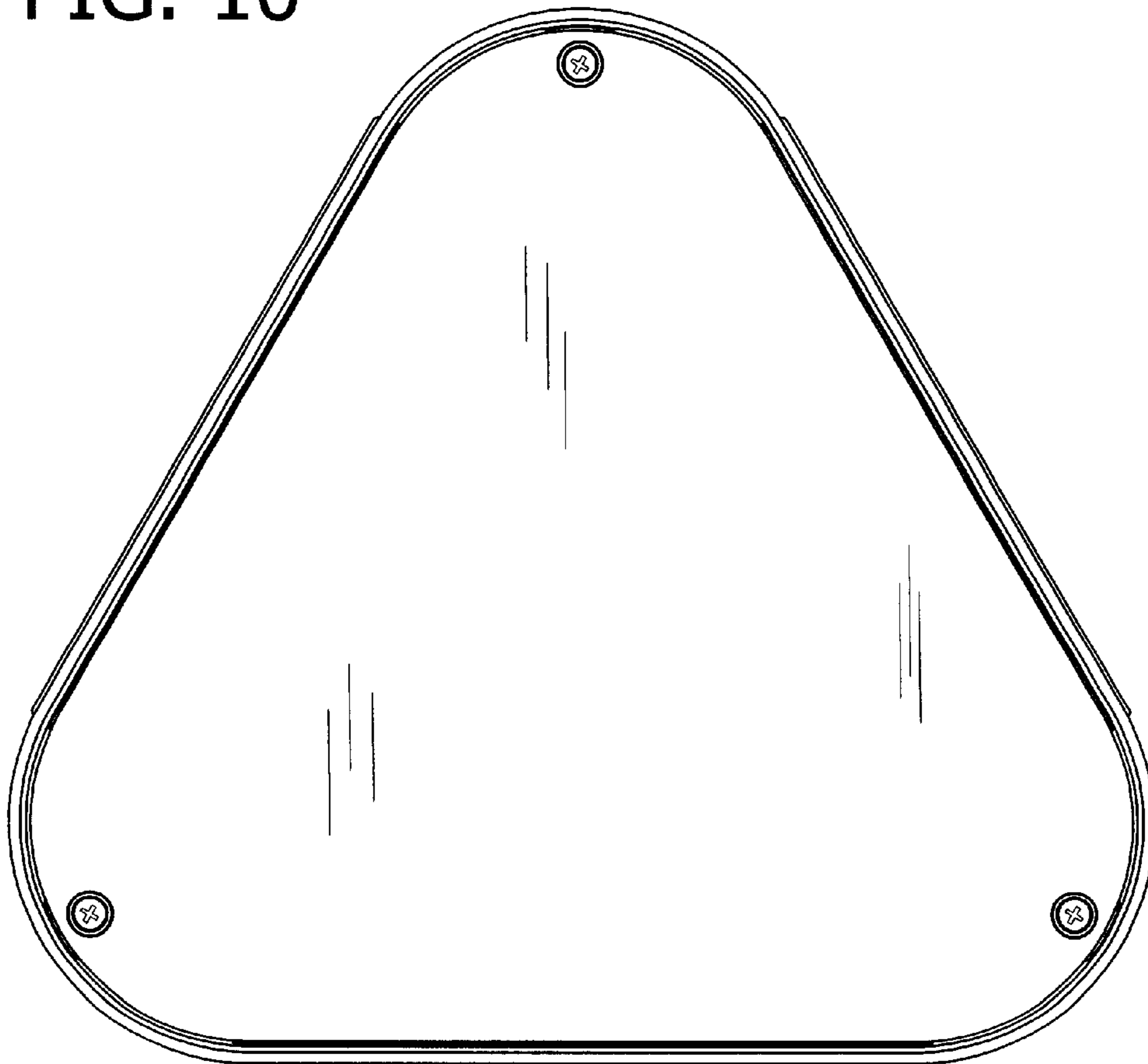

FIG. 11

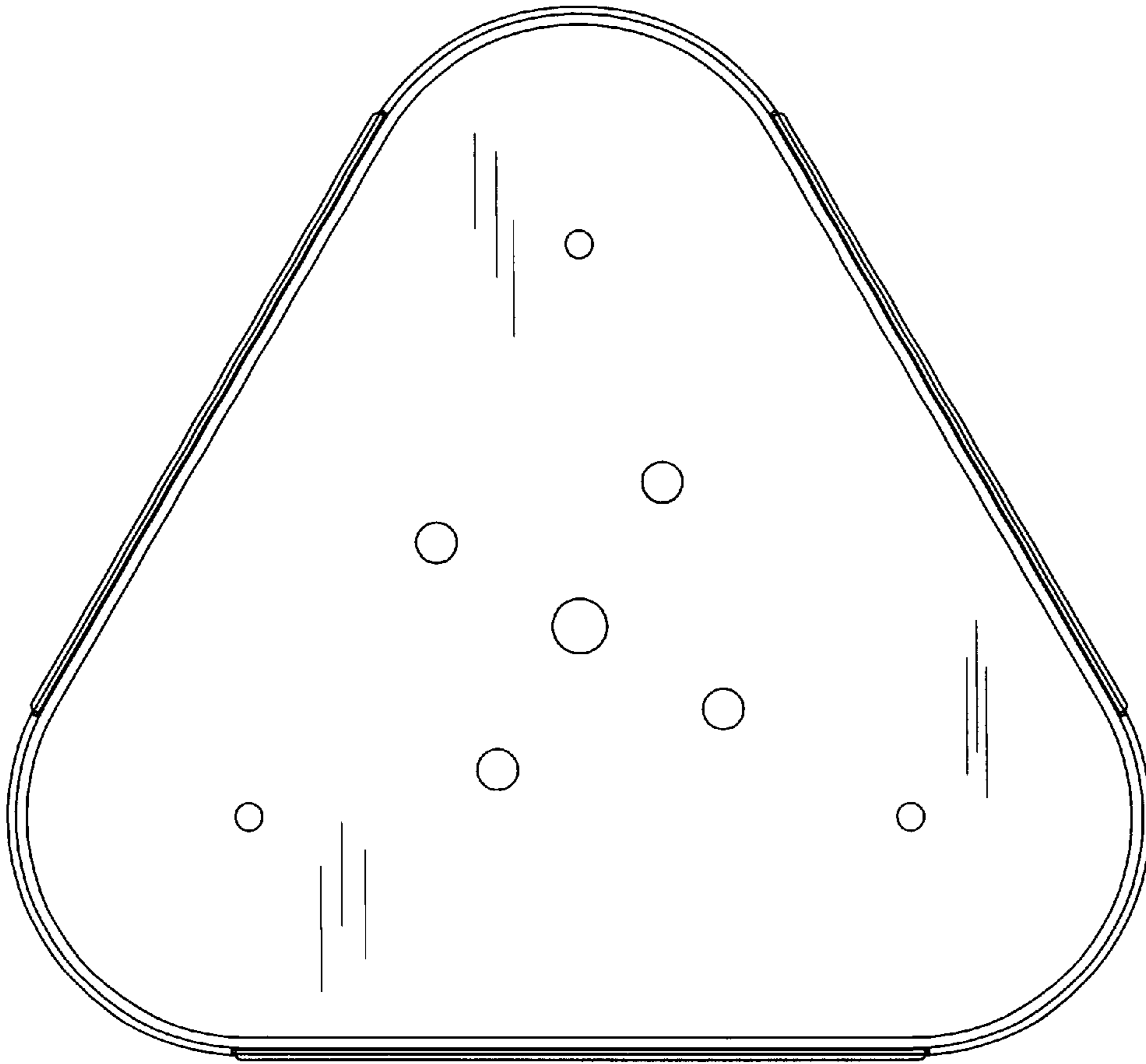

FIG. 12

