



US00D520357S

(12) **United States Design Patent**
Terrasi

(10) **Patent No.:** **US D520,357 S**

(45) **Date of Patent:** **** May 9, 2006**

(54) **PACKAGING FOR FOOD PRODUCTS, SUCH AS CONFECTIONARY PRODUCTS**

(75) Inventor: **Giuseppe Terrasi**, Benevello (IT)

(73) Assignee: **Soremartec, S.A.**, Schoppach Arlon (BE)

(**) Term: **14 Years**

(21) Appl. No.: **29/209,876**

(22) Filed: **Jul. 23, 2004**

(30) **Foreign Application Priority Data**

Jan. 26, 2004 (EM) 000133251

(51) **LOC (8) Cl.** **09-03**

(52) **U.S. Cl.** **D9/428**

(58) **Field of Classification Search** D9/428,
D9/414, 415, 416, 424; D7/510; 206/822;
220/4.1

See application file for complete search history.

(56) **References Cited**

U.S. PATENT DOCUMENTS

D375,258 S * 11/1996 Weder et al. D9/414

D407,640 S * 4/1999 Nelson et al. D9/416

D431,863 S * 10/2000 Richardson D24/104

D436,860 S * 1/2001 Raso D9/416

D445,673 S * 7/2001 Richardson D9/416

D445,674 S * 7/2001 Pritchett D9/416

* cited by examiner

Primary Examiner—Stella Reid

Assistant Examiner—Derrick Holland

(74) *Attorney, Agent, or Firm*—Rothwell, Figg, Ernst & Manbeck

(57) **CLAIM**

The ornamental design for a packaging for food products, such as confectionary products, as shown and described.

DESCRIPTION

FIG. 1 is a perspective view of the packaging for food products showing my new design;

FIG. 2 is a front view thereof;

FIG. 3 is a right view thereof;

FIG. 4 is a left view thereof;

FIG. 5 is a rear view thereof;

FIG. 6 is a top view thereof; and,

FIG. 7 is a bottom view thereof.

1 Claim, 4 Drawing Sheets

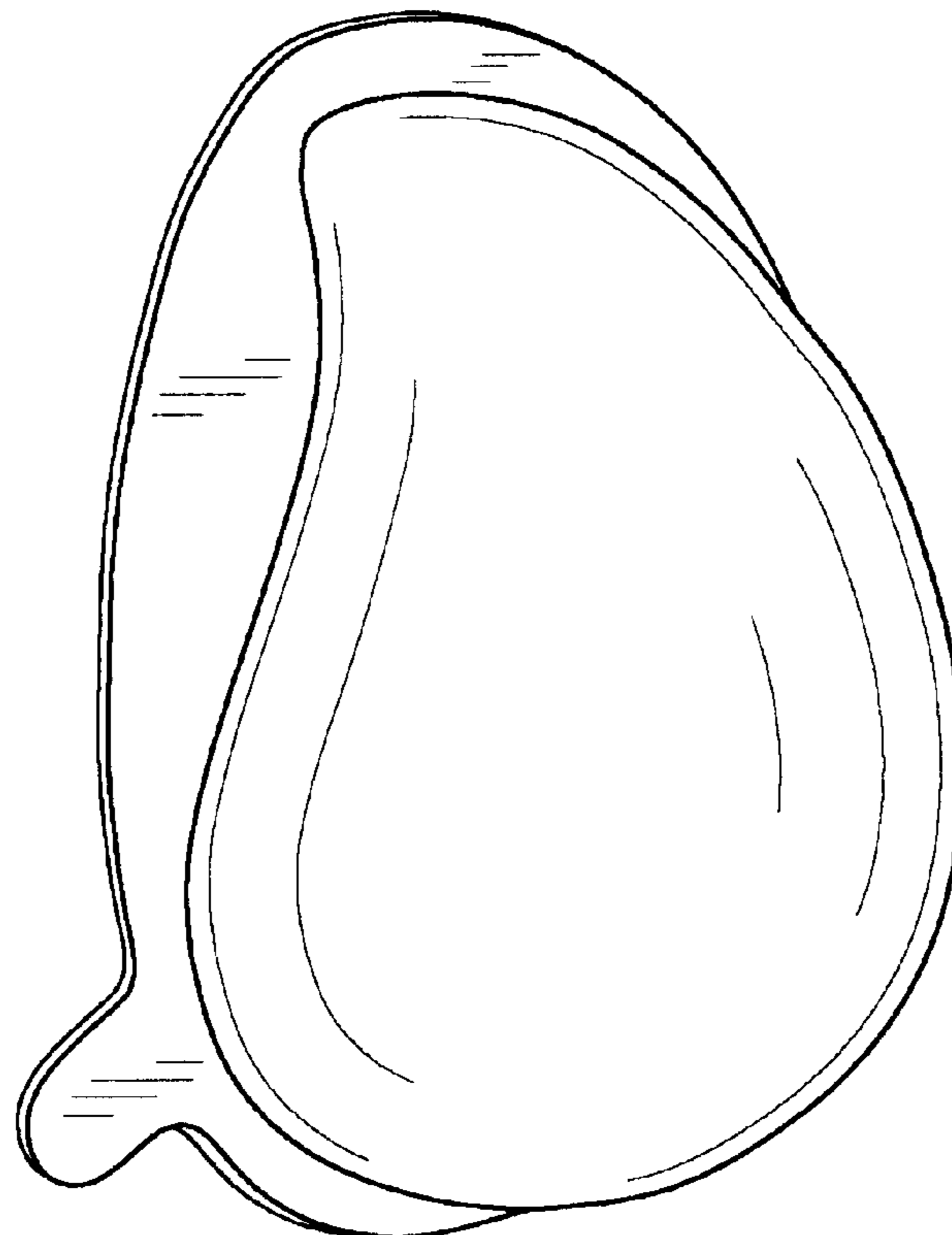

FIG. 1

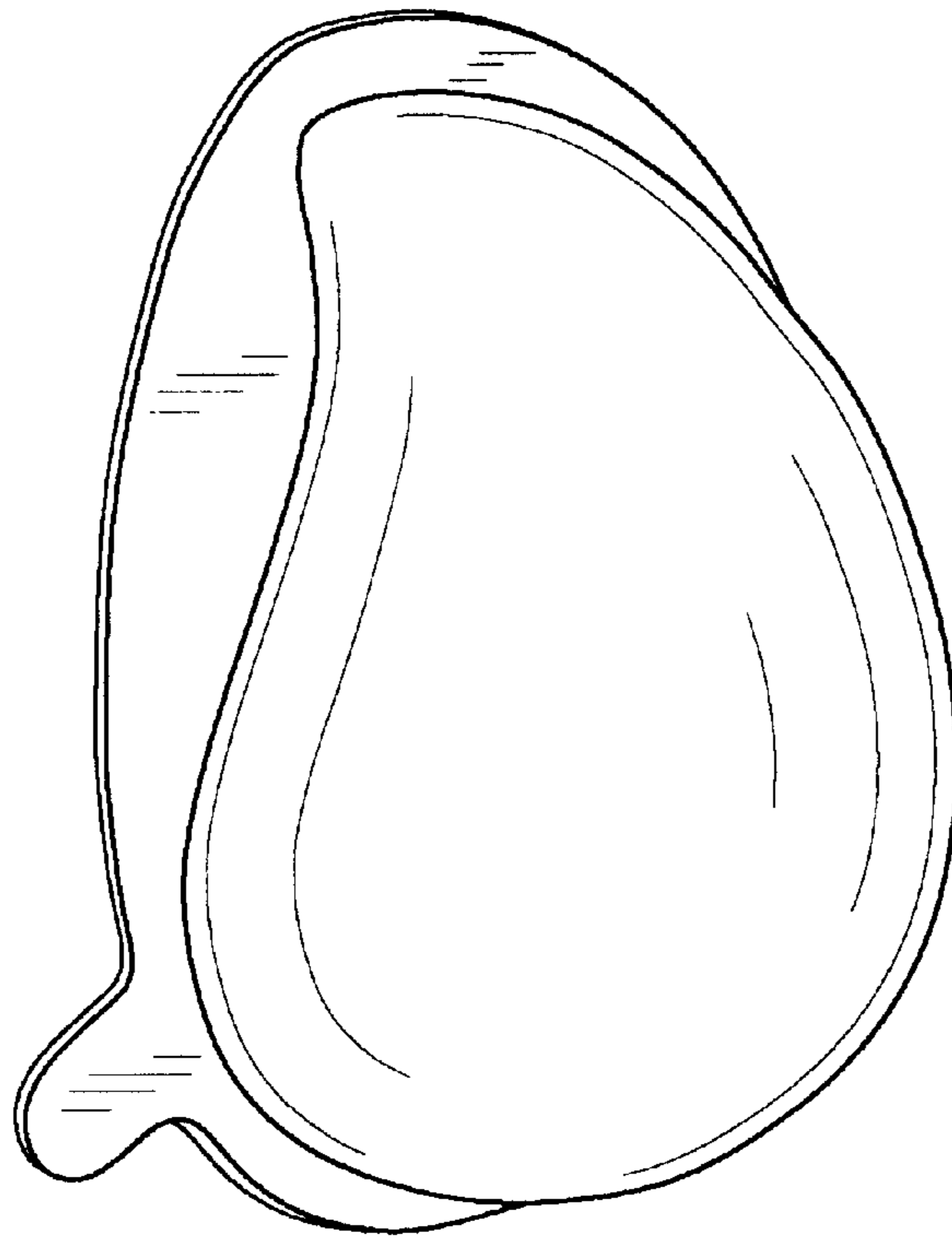

FIG. 2

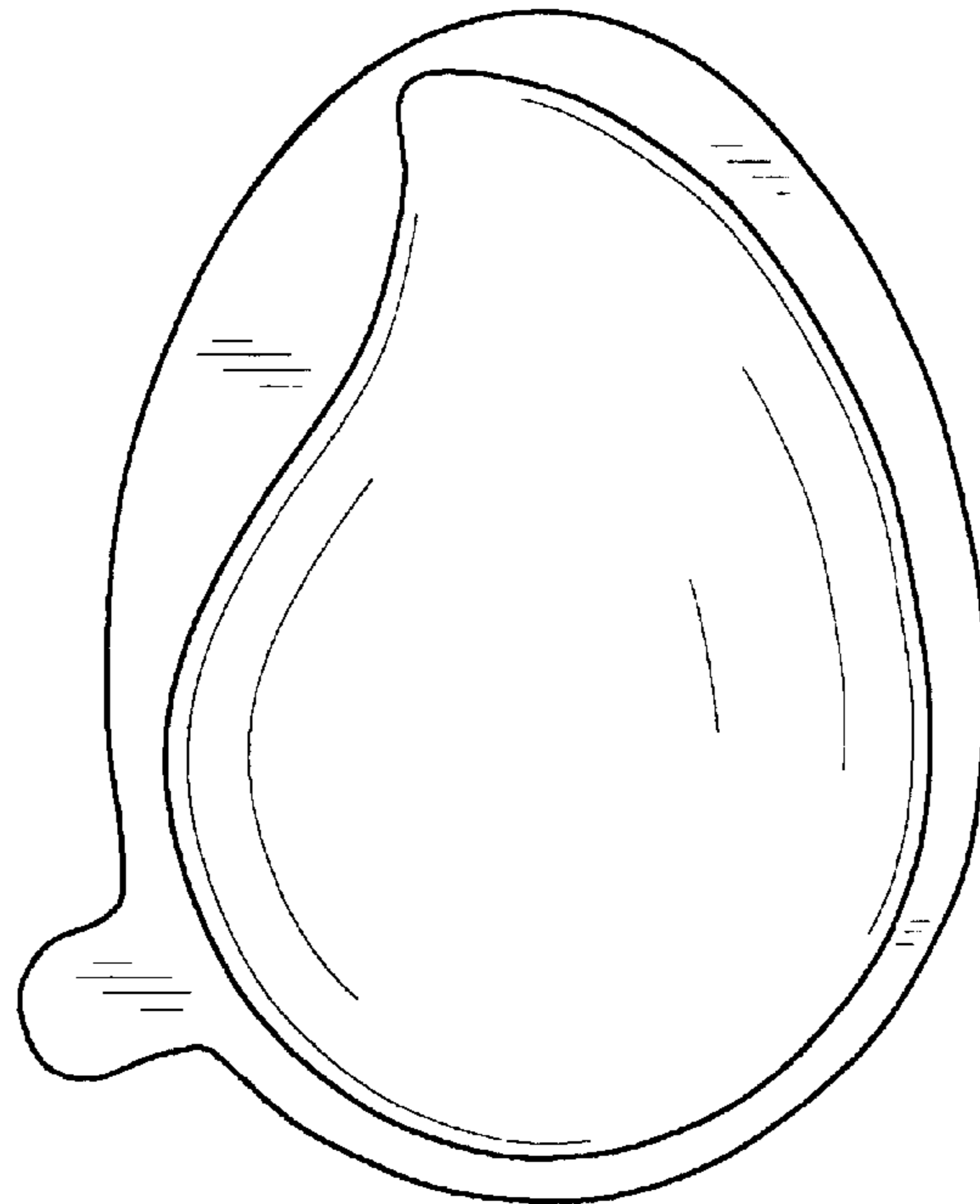

FIG. 3

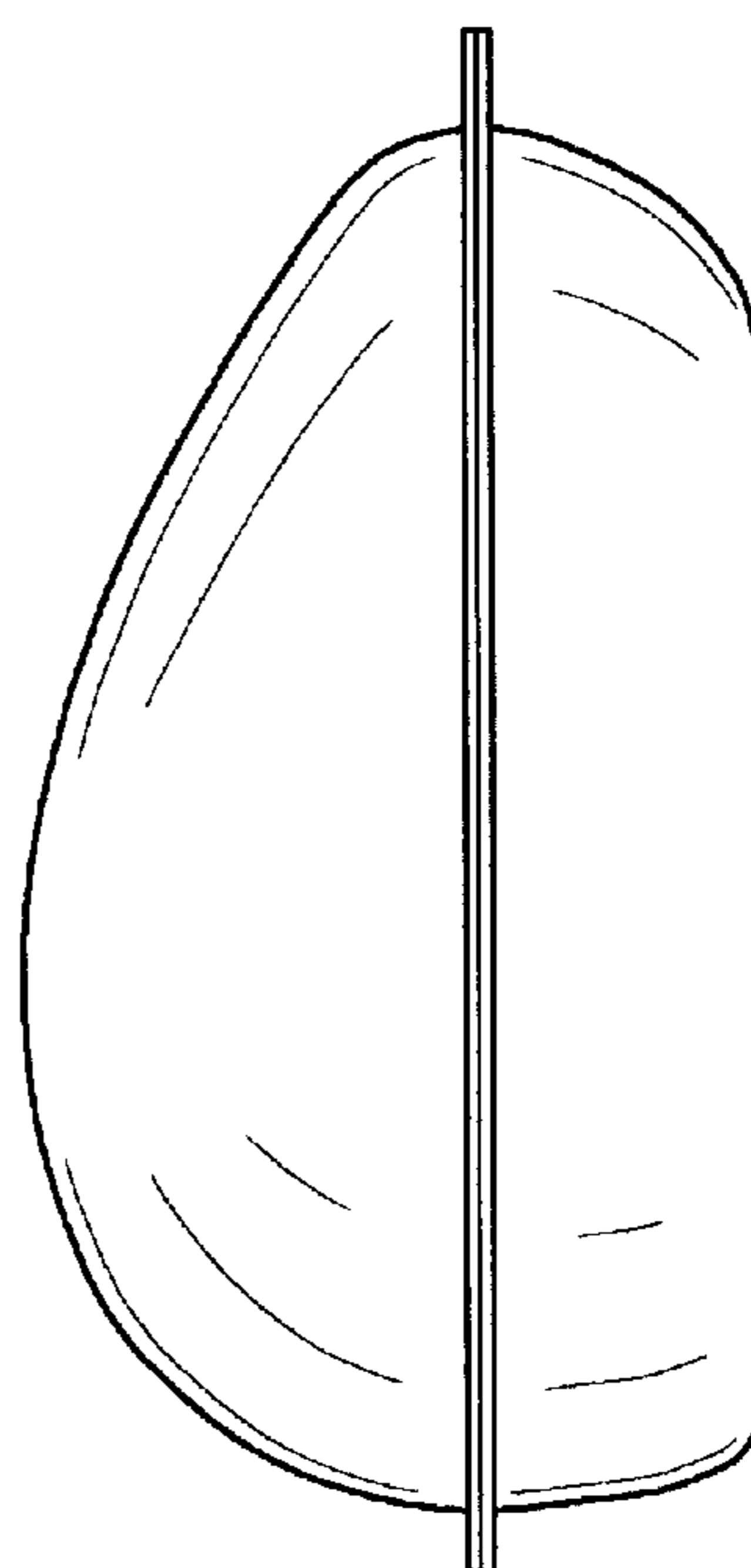

FIG. 4

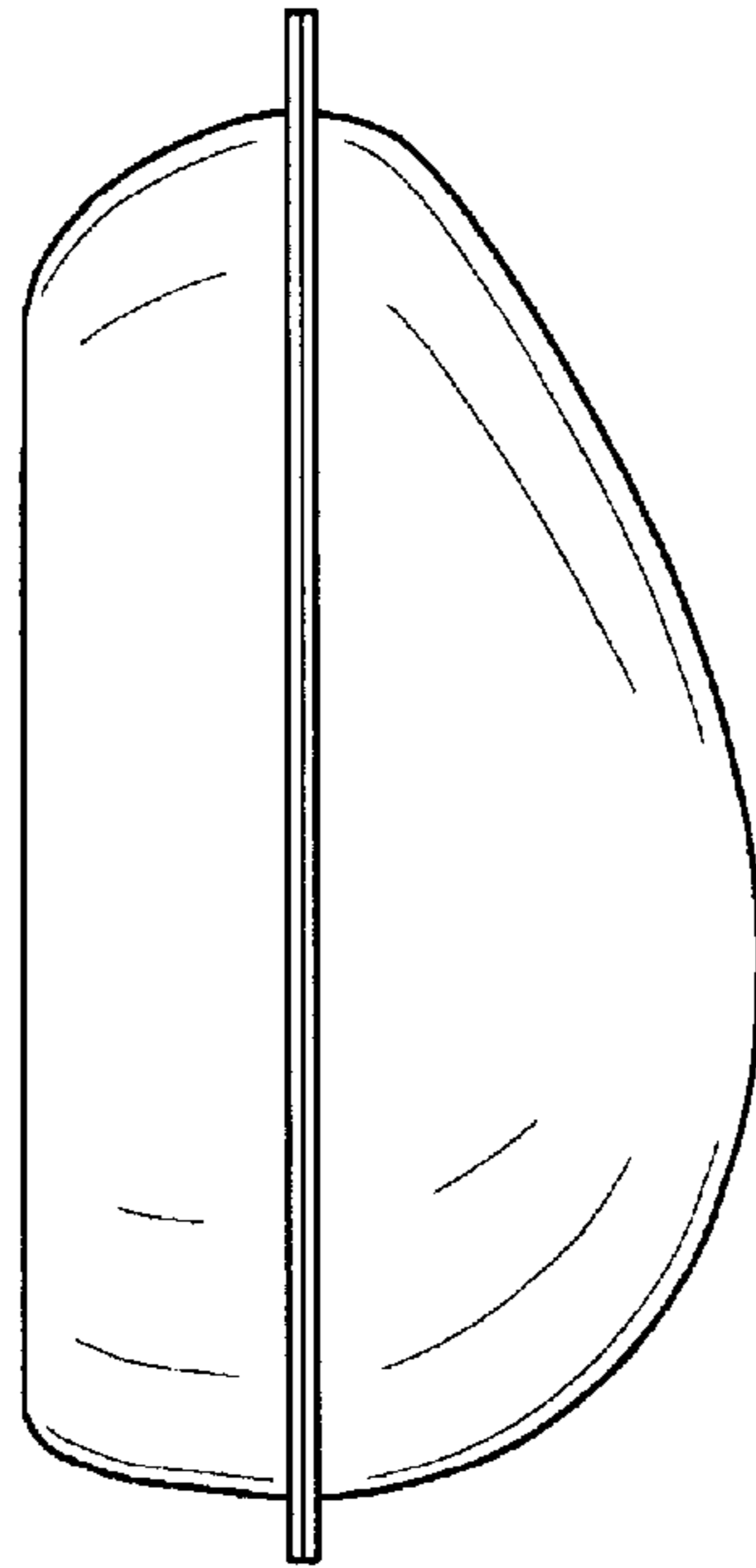

FIG. 5

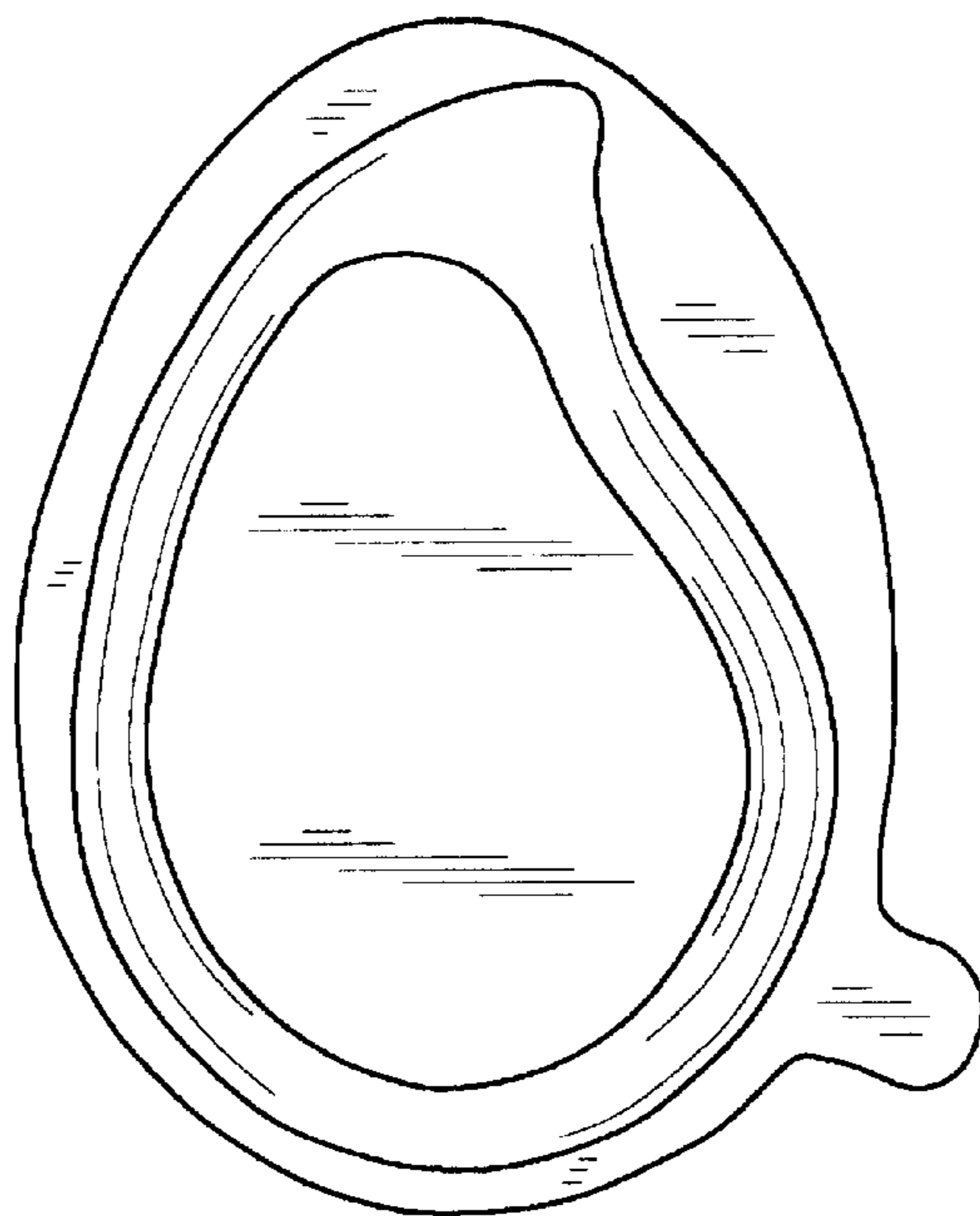

FIG. 6

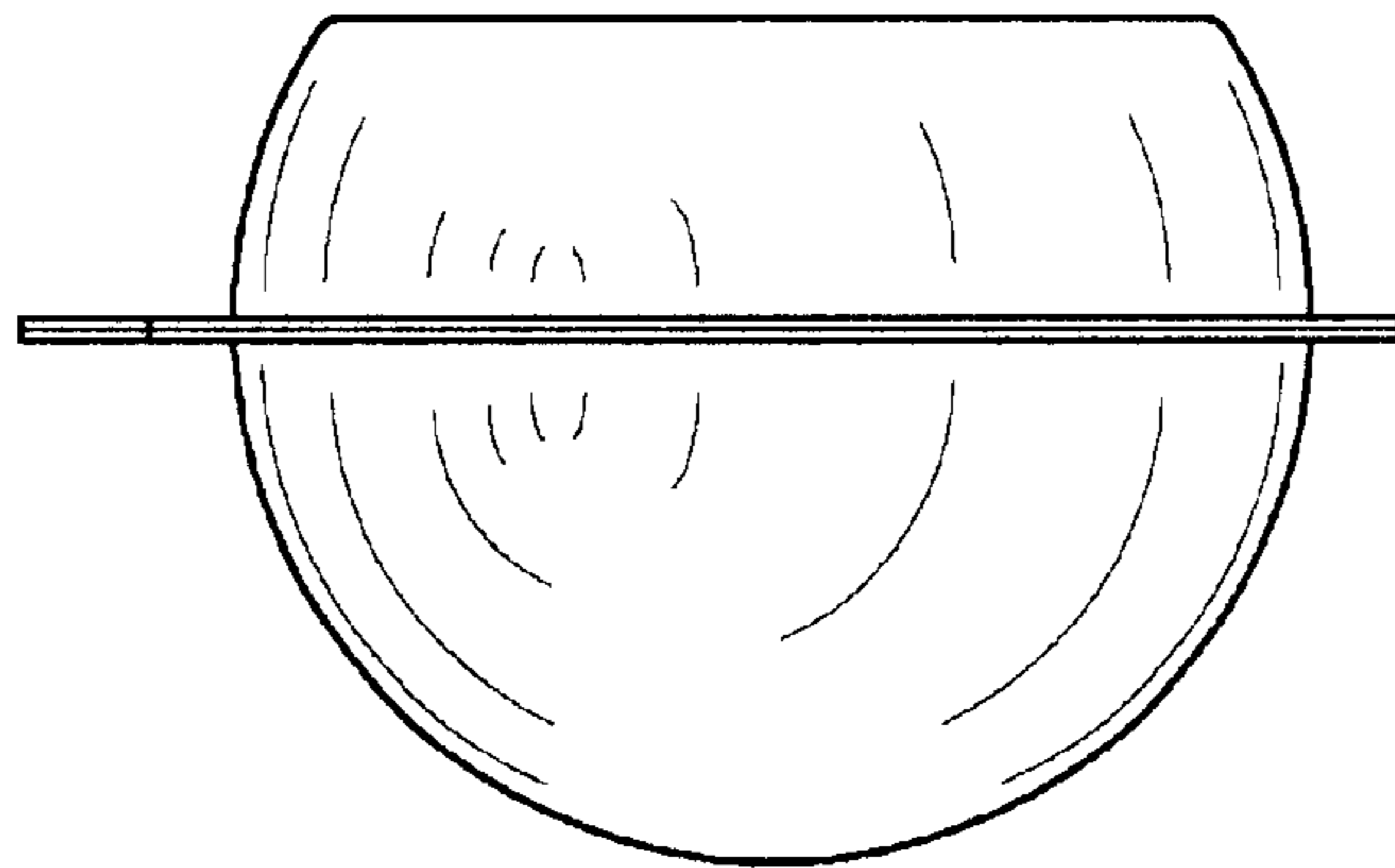

FIG. 7

