



US00D520322S

(12) **United States Design Patent**  
**Orlando**

(10) **Patent No.:** **US D520,322 S**

(45) **Date of Patent:** **\*\* May 9, 2006**

(54) **CUTTING ACCESSORY**

(76) Inventor: **Wayne Orlando**, 30901 Huntington Woods, Bay Village, OH (US) 44140

(\*\*) Term: **14 Years**

(21) Appl. No.: **29/204,412**

(22) Filed: **Apr. 30, 2004**

(51) **LOC (8) Cl.** ..... **08-05**

(52) **U.S. Cl.** ..... **D8/70; D8/354**

(58) **Field of Classification Search** ..... D12/223; 248/300, 127, 146, 156; D8/71, 14, 70, 72, D8/73, 74, 349, 354, 373, 395, 16; D6/553; D15/130, 132, 138, 139, 140, 141; 173/132; 206/349; 211/70.1, 70.6; 125/13.01; 408/1 R  
See application file for complete search history.

(56) **References Cited**

**U.S. PATENT DOCUMENTS**

2,996,277	A	*	8/1961	Hoffman	.....	248/300
3,436,155	A	*	4/1969	Perin, Jr.	.....	408/1 R
4,031,664	A	*	6/1977	Wendt	.....	248/300
4,040,589	A	*	8/1977	McLay	.....	248/300
D246,572	S	*	12/1977	Walter	.....	D8/71
D249,956	S	*	10/1978	Potts	.....	D8/71
D254,595	S	*	4/1980	Hart	.....	D8/349
4,278,225	A	*	7/1981	Phelps	.....	D8/373
D262,862	S	*	2/1982	Lytle	.....	D8/71
D265,050	S	*	6/1982	Riedl	.....	D8/354
D265,285	S	*	7/1982	Englert, Jr.	.....	D8/354
D270,574	S	*	9/1983	Black	.....	D8/354
4,406,064	A	*	9/1983	Goss	.....	D8/70
D274,033	S	*	5/1984	Miller	.....	D8/71
4,447,030	A	*	5/1984	Nattel	.....	D8/349
D275,178	S	*	8/1984	Yeater	.....	D8/349
D285,647	S	*	9/1986	Sachs	.....	D8/354
D302,234	S	*	7/1989	McNamee et al.	.....	D8/71
D312,205	S	*	11/1990	de Rooij	.....	D8/349

D323,836	S	*	2/1992	Woolman et al.	.....	D15/140
D341,529	S	*	11/1993	Jacobs	.....	D8/16
D342,011	S	*	12/1993	Maguire	.....	D8/349
D349,041	S	*	7/1994	Wical	.....	D8/373
D360,544	S	*	7/1995	Gauthier	.....	D8/349
D381,338	S	*	7/1997	Johansson	.....	D8/349
D415,950	S	*	11/1999	Anderson	.....	D8/354
6,131,361	A	*	10/2000	Murphy	.....	248/300
D433,604	S	*	11/2000	Tipp	.....	D8/14
6,702,240	B1	*	3/2004	Bradley	.....	248/300
2003/0196648	A1	*	10/2003	Schroer et al.	.....	125/13.01

\* cited by examiner

*Primary Examiner*—Gary D. Watson  
*Assistant Examiner*—T. Chase Nelson  
(74) *Attorney, Agent, or Firm*—Joseph H. Taddeo

(57) **CLAIM**

The ornamental design for a cutting accessory, as shown and described.

**DESCRIPTION**

FIG. 1 is a front view of the invention;  
FIG. 2 is a back view of the invention;  
FIG. 3 is a right side view of the invention;  
FIG. 4 is a left side view of the invention;  
FIG. 5 is a top view of the invention;  
FIG. 6 is a bottom view of the invention;  
FIG. 7 is a three quarters perspective view of the invention;  
and,  
FIG. 8 is a three quarters perspective view of the invention shown in condition of use with the invention attached to a broken line depiction of a device. The broken lines in this view form no part of the claimed design.  
The broken lines upon the surface of the cutting accessory in the FIGS. 1 and 6 views are visible on the cutting accessory, and do form a part of the claimed design.

**1 Claim, 2 Drawing Sheets**

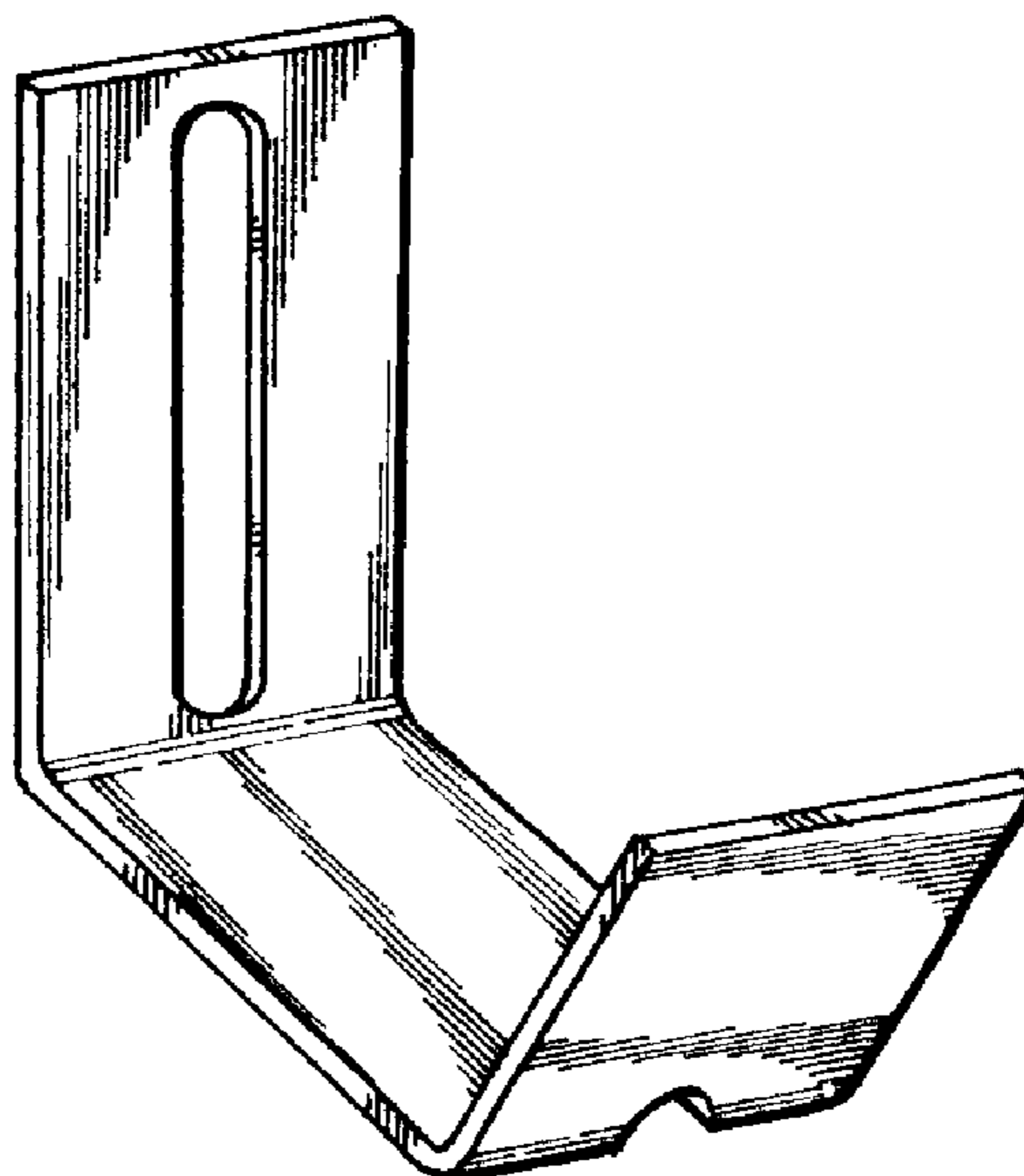

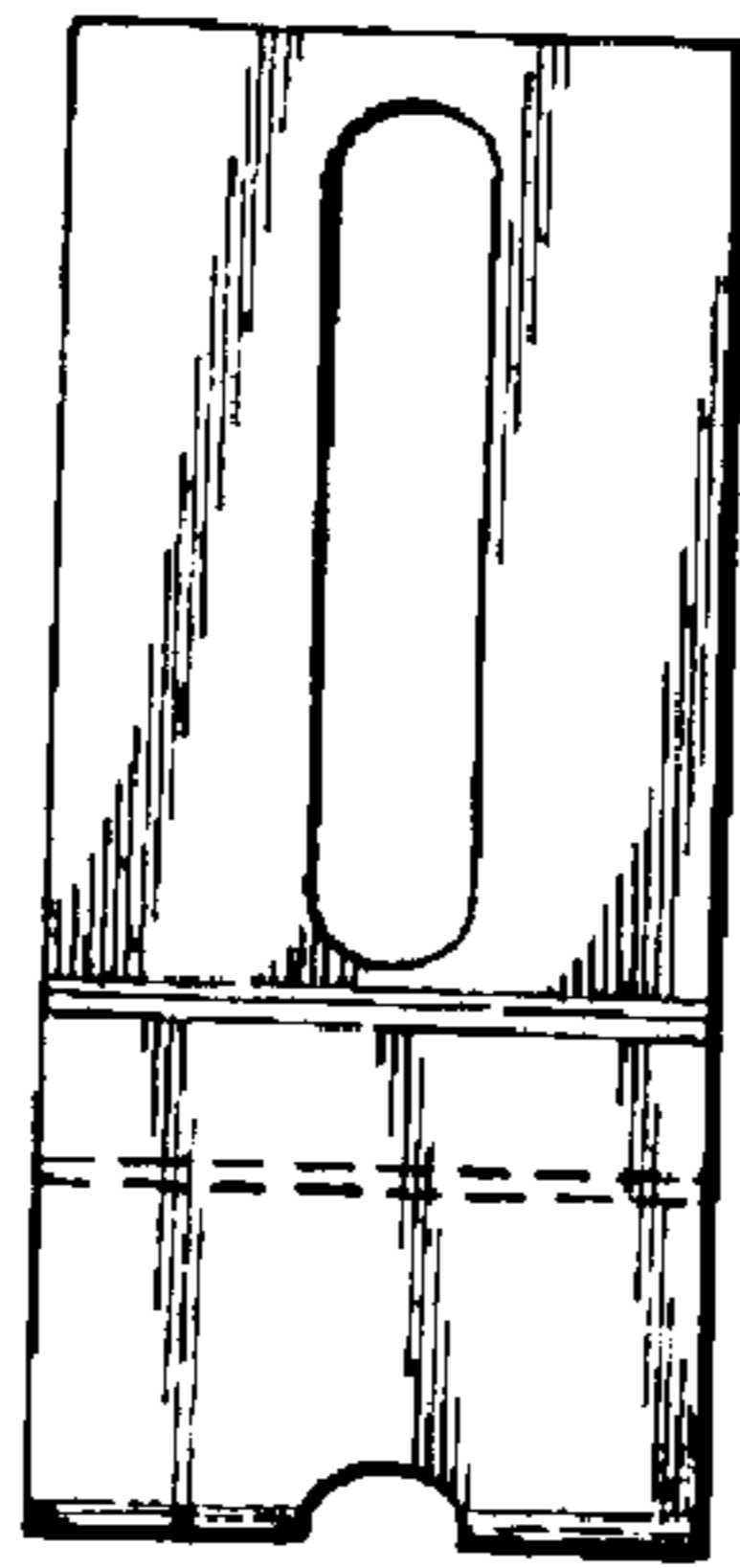

FIG. 1

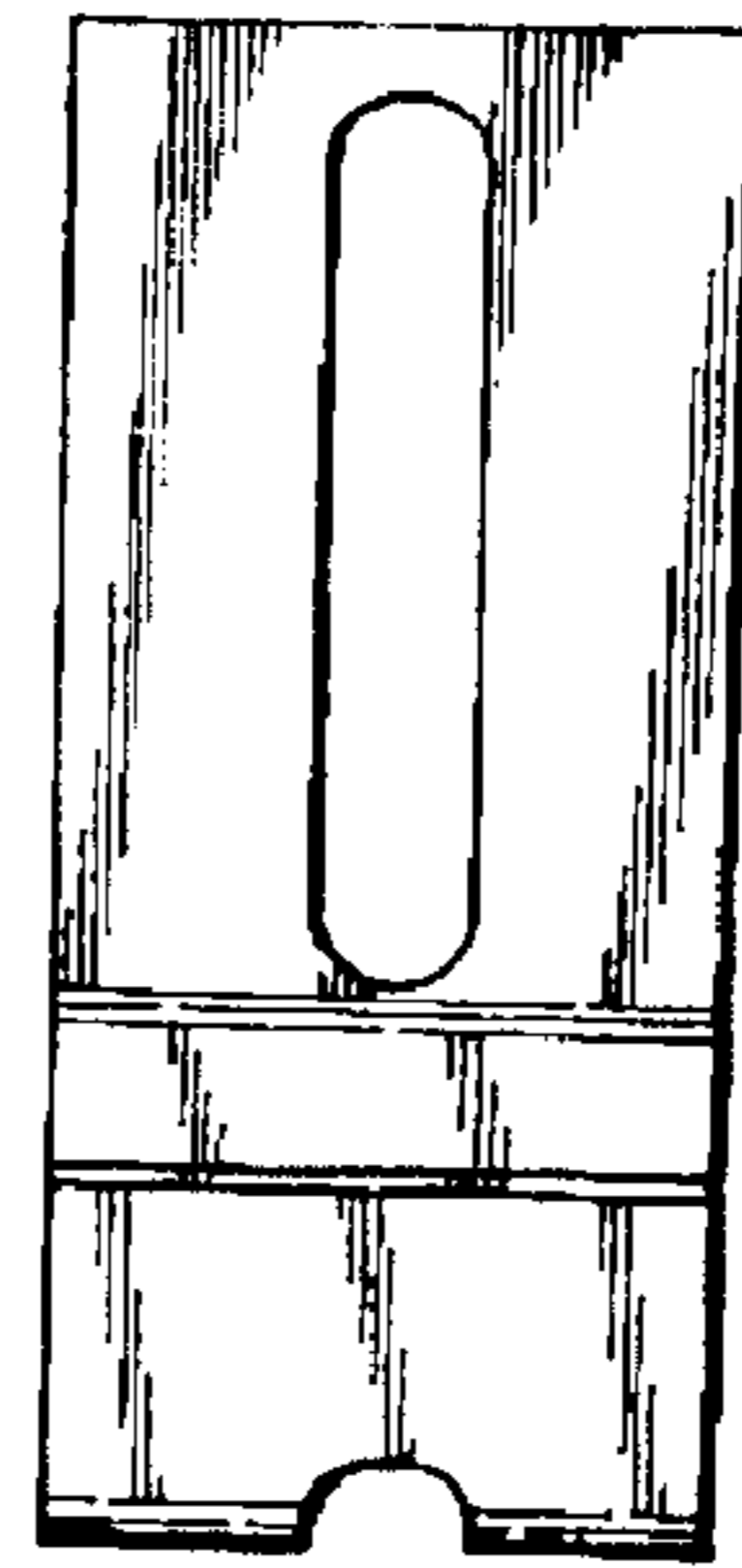

FIG. 2

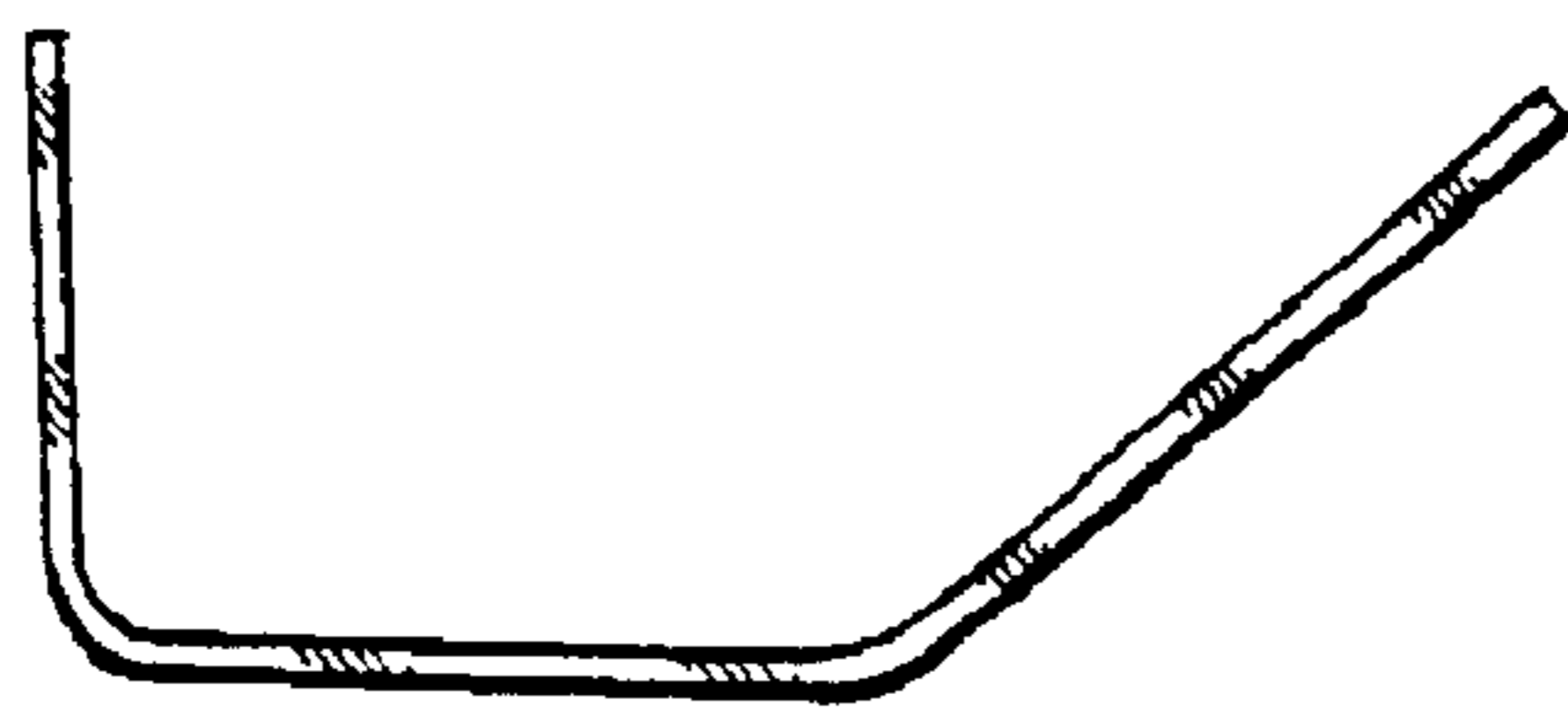

FIG. 3

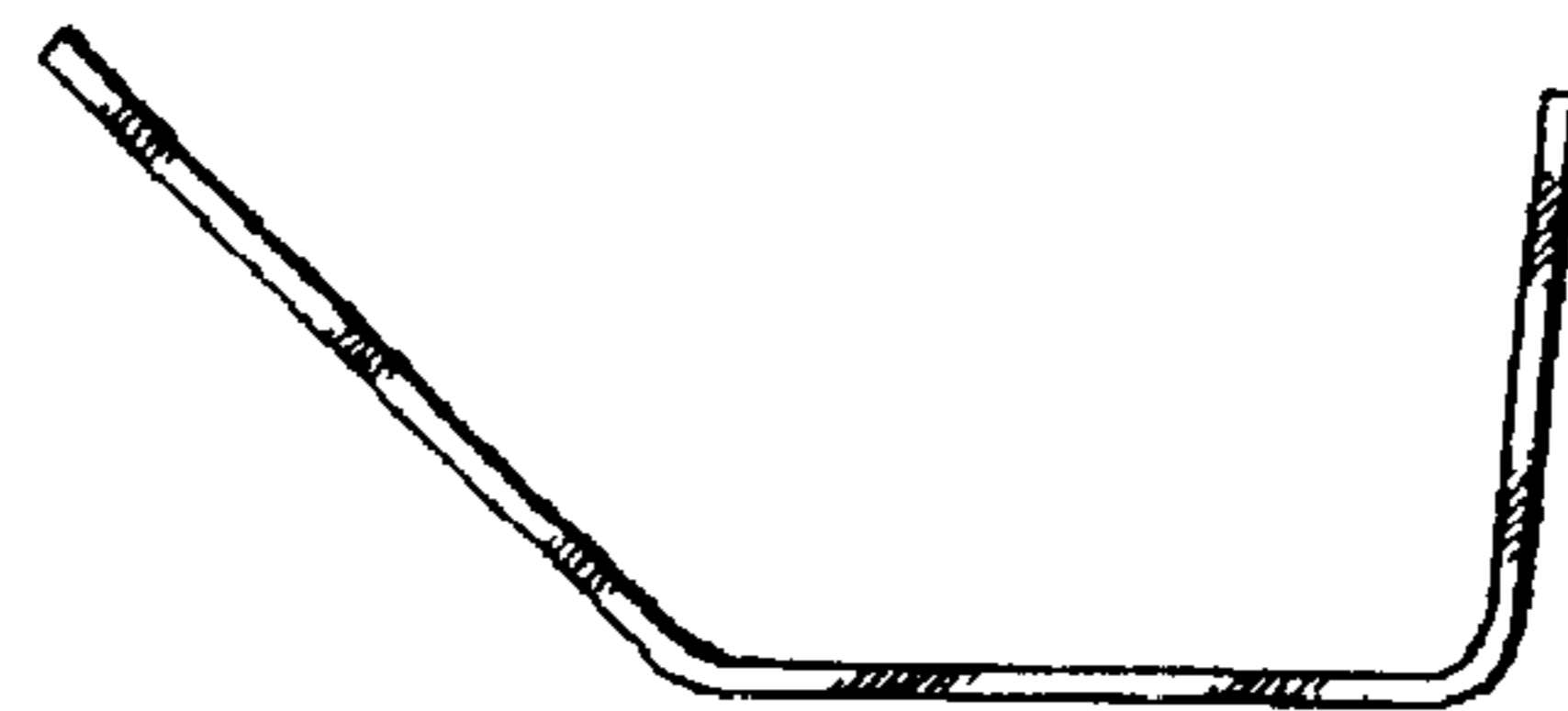

FIG. 4

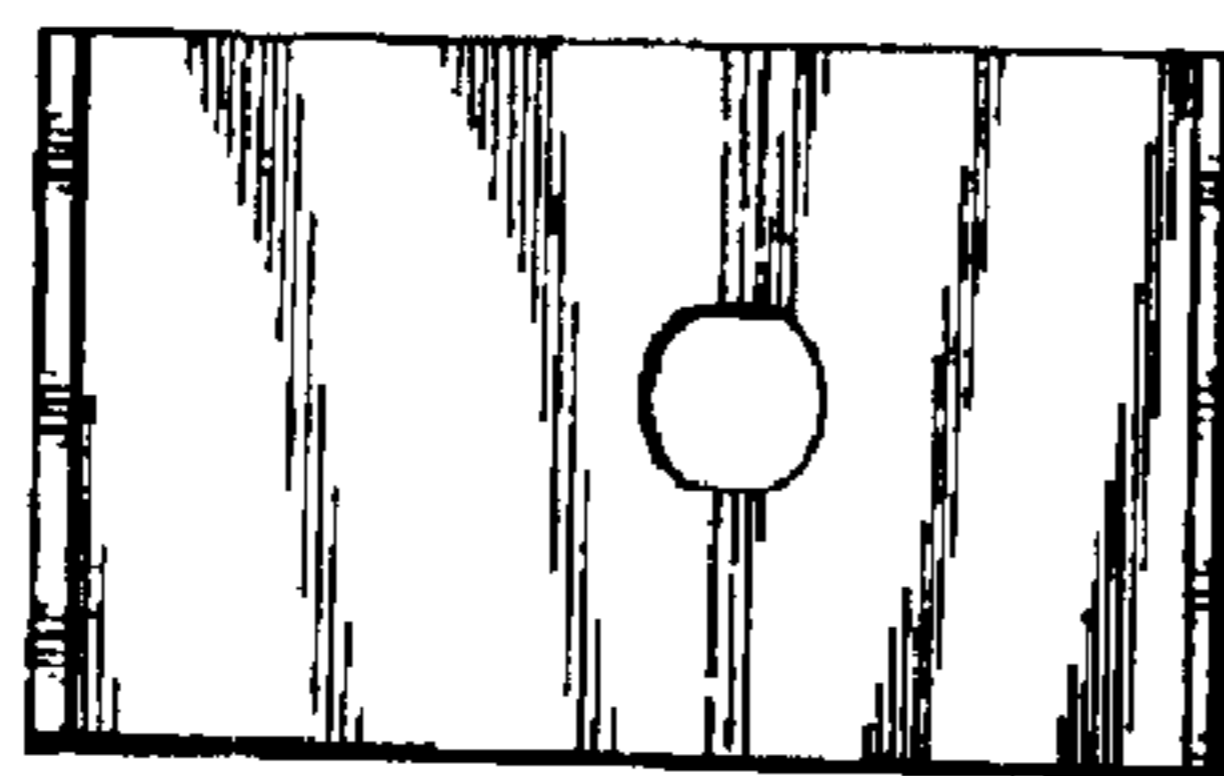

FIG. 5

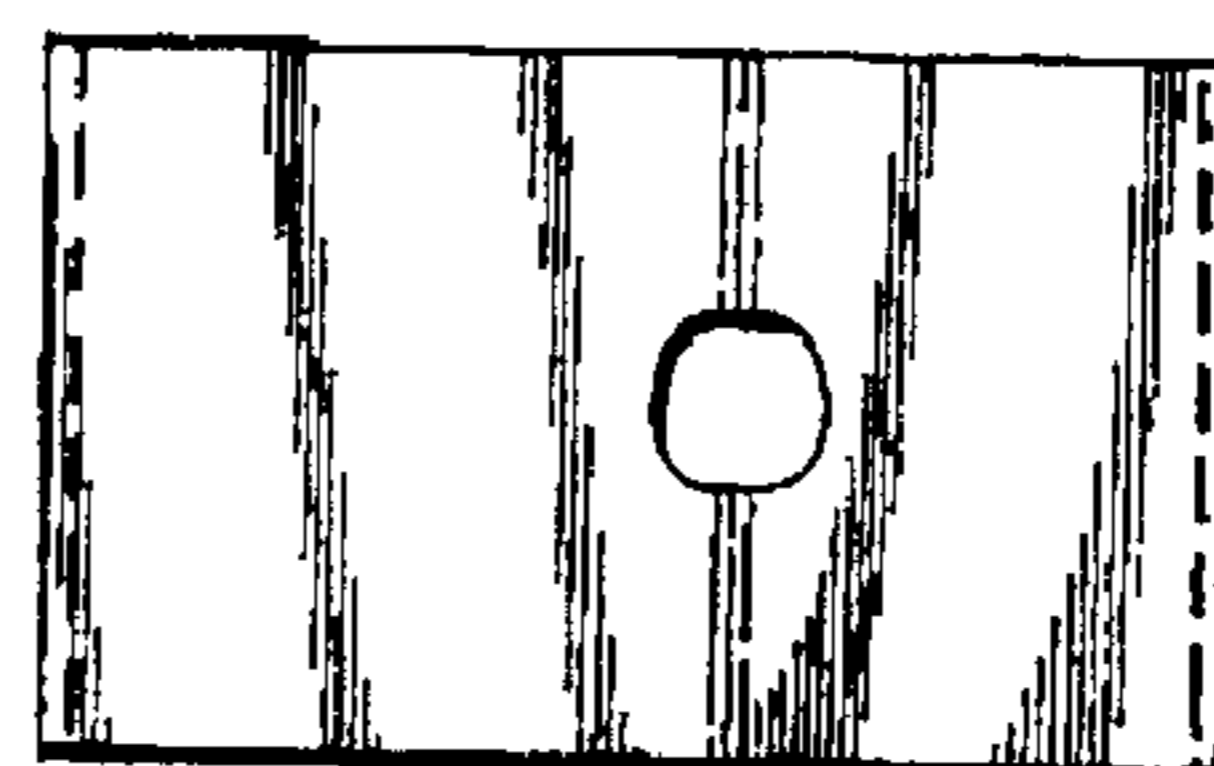

FIG. 6

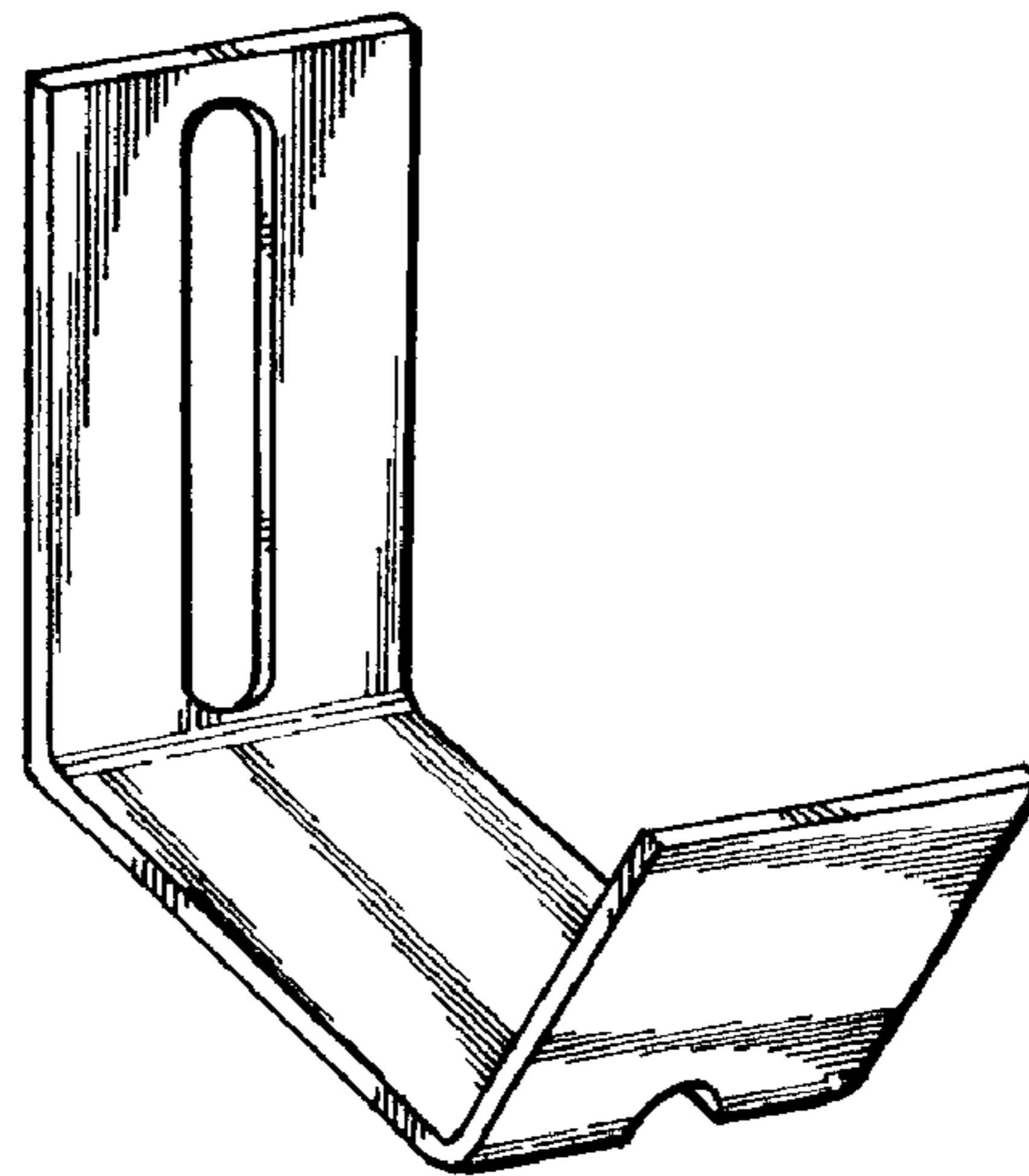

FIG. 7

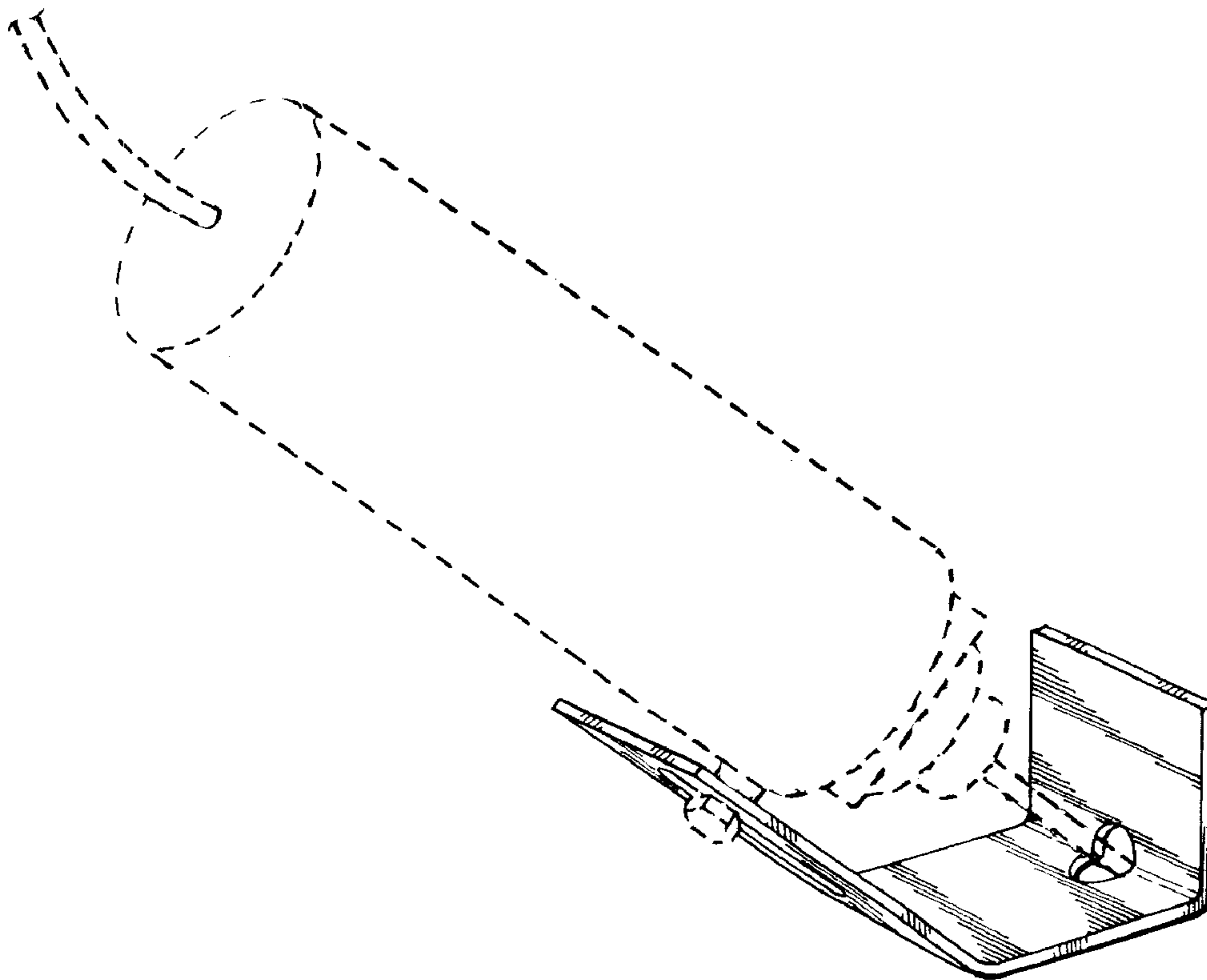

FIG. 8