



US00D520201S

(12) **United States Design Patent**
Dyson et al.

(10) **Patent No.:** **US D520,201 S**

(45) **Date of Patent:** **** May 2, 2006**

(54) **ACCESSORY FOR A CLEANING APPLIANCE**

(75) Inventors: **James Dyson**, Dodington (GB);
Samuel Emrys James, Bath (GB);
William Robert James White,
Malmesbury (GB)

(73) Assignee: **Dyson Limited**, Wiltshire (GB)

(**) Term: **14 Years**

(21) Appl. No.: **29/227,240**

(22) Filed: **Apr. 8, 2005**

(30) **Foreign Application Priority Data**

Oct. 8, 2004 (GB) 3019029

(51) **LOC (8) Cl.** **15-05**

(52) **U.S. Cl.** **D32/33**

(58) **Field of Classification Search** D32/22,
D32/30-34; 15/321-322, 329, 400, 410-411,
15/414-415.1, 416-422.1, 327.1, 394, 351;
285/7; D8/300, 302-303, 310, 317; 16/110.1
See application file for complete search history.

(56) **References Cited**

U.S. PATENT DOCUMENTS

D206,055 S * 10/1966 Bearse et al. D32/32

D244,274 S * 5/1977 Winard et al. D32/33
D368,995 S * 4/1996 Stryffeler D32/32
D470,633 S * 2/2003 Kitts D32/33
D483,536 S * 12/2003 Martin D32/31
6,772,477 B1 * 8/2004 Murphy et al. 15/415.1
D506,046 S * 6/2005 Schroter D32/32
2004/0177469 A1 * 9/2004 Sadaune et al. 15/322

* cited by examiner

Primary Examiner—Ruth McInroy

(74) *Attorney, Agent, or Firm*—Morrison & Foerster LLP

(57) **CLAIM**

We claim the ornamental design for an accessory for a cleaning appliance, as shown and described.

DESCRIPTION

FIG. 1 is a front view of an accessory for a cleaning appliance showing our new design;
FIG. 2 is a rear view thereof;
FIG. 3 is a side view thereof;
FIG. 4 is a side view opposite FIG. 3;
FIG. 5 is a top view thereof; and,
FIG. 6 is a bottom view thereof.

1 Claim, 5 Drawing Sheets

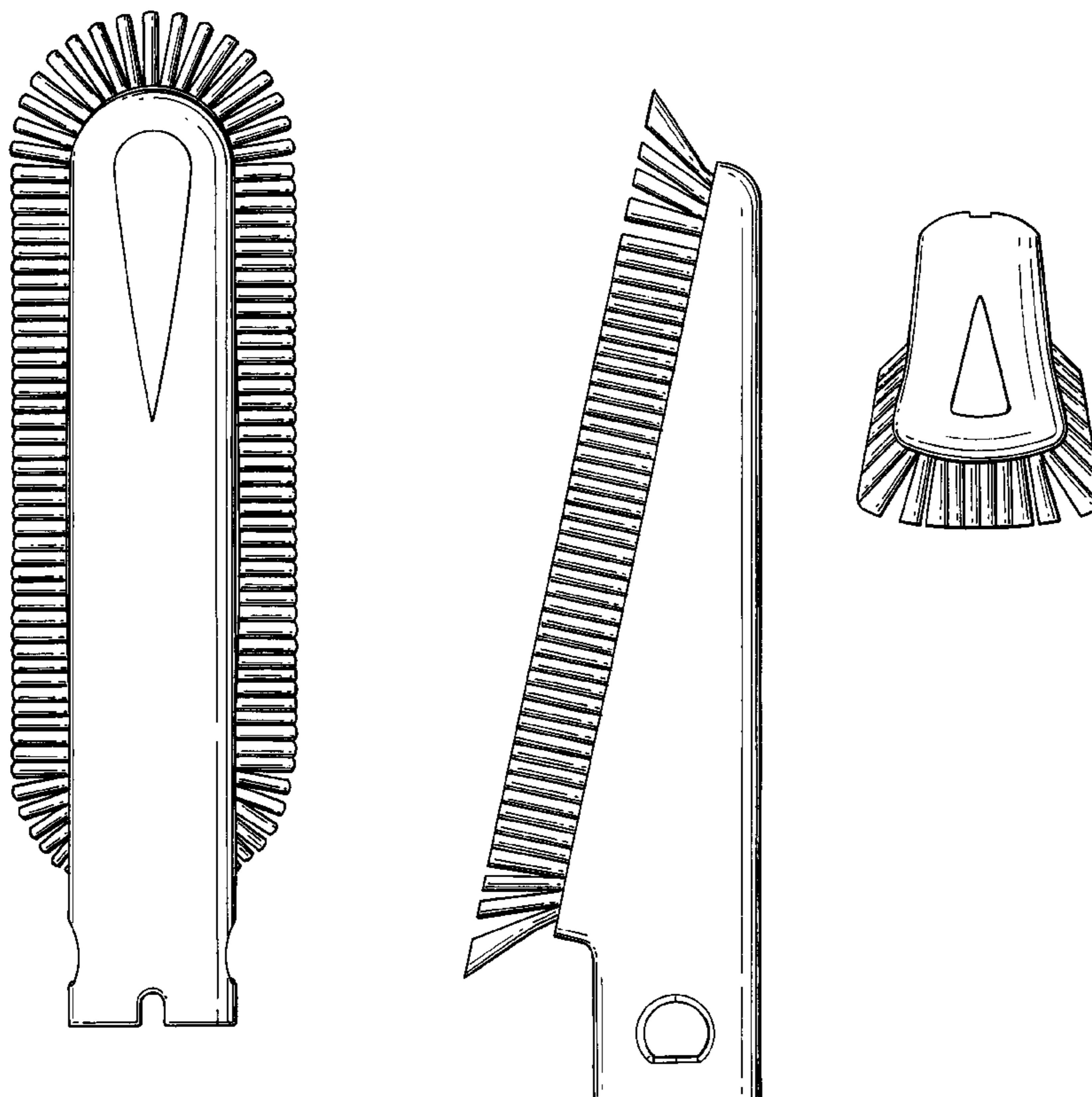

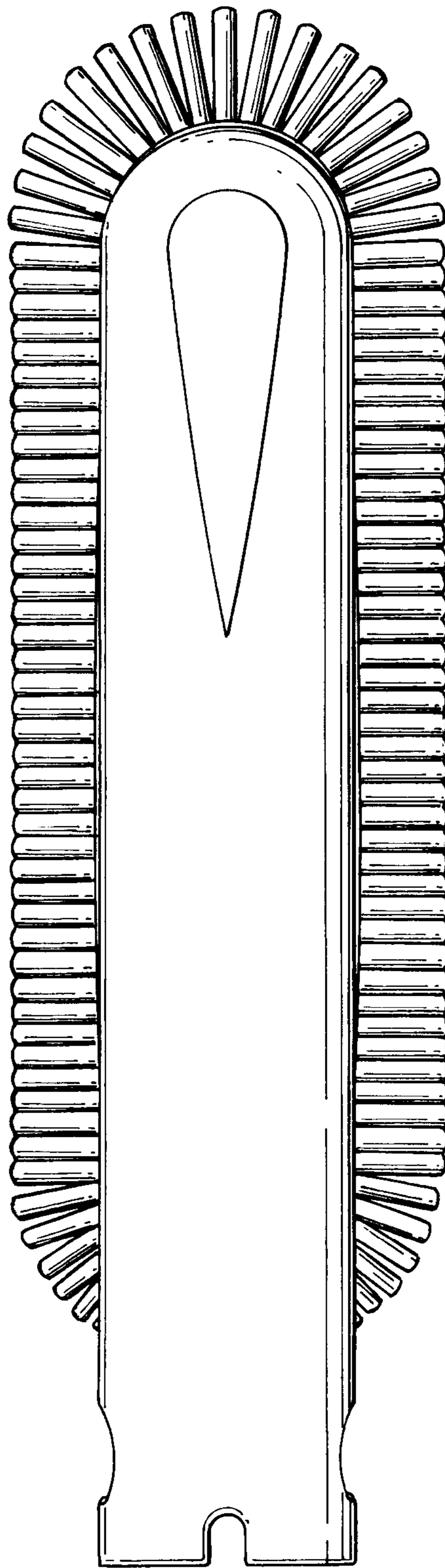

Fig. 1

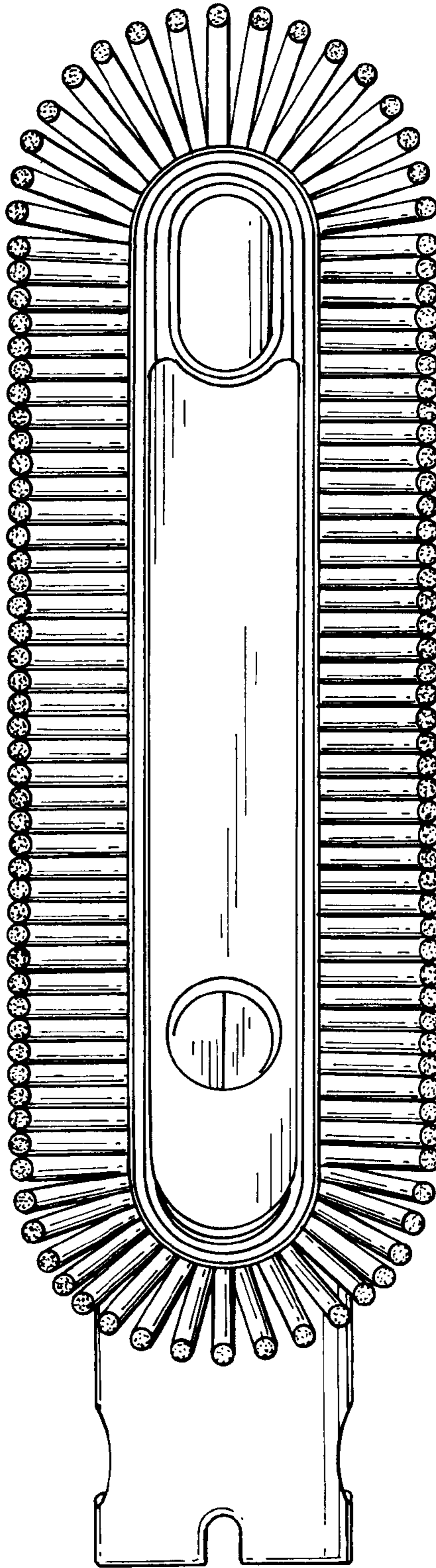

Fig. 2

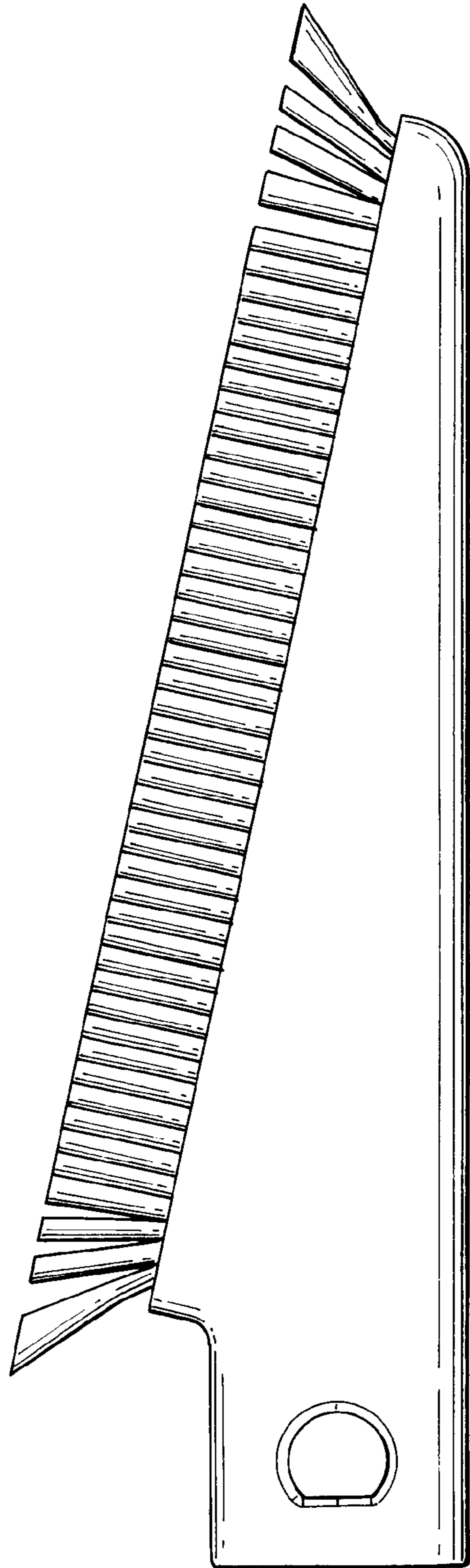

Fig. 3

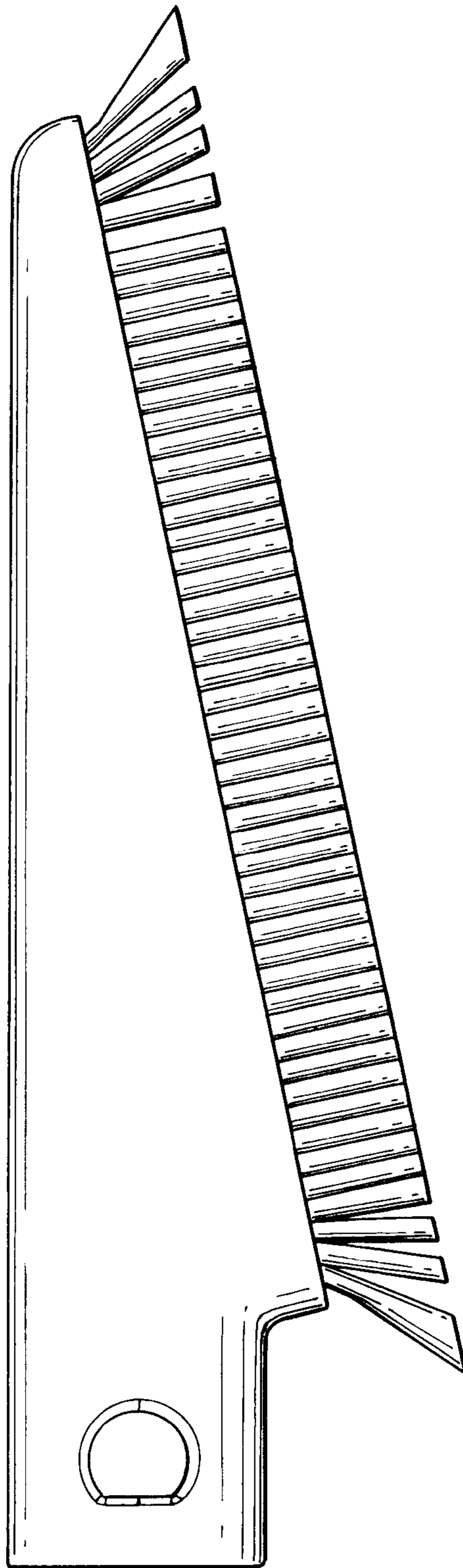

Fig. 4

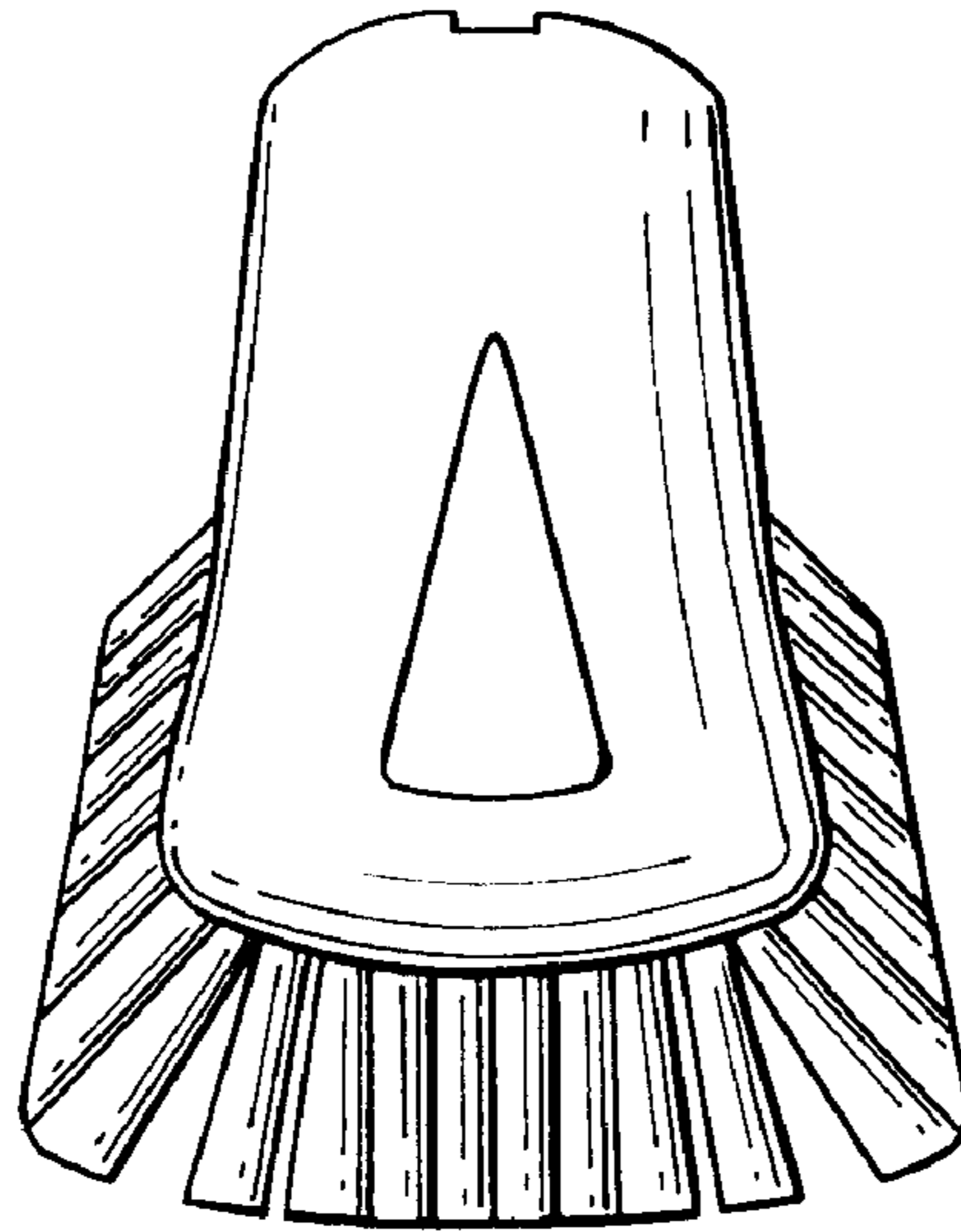

Fig. 5

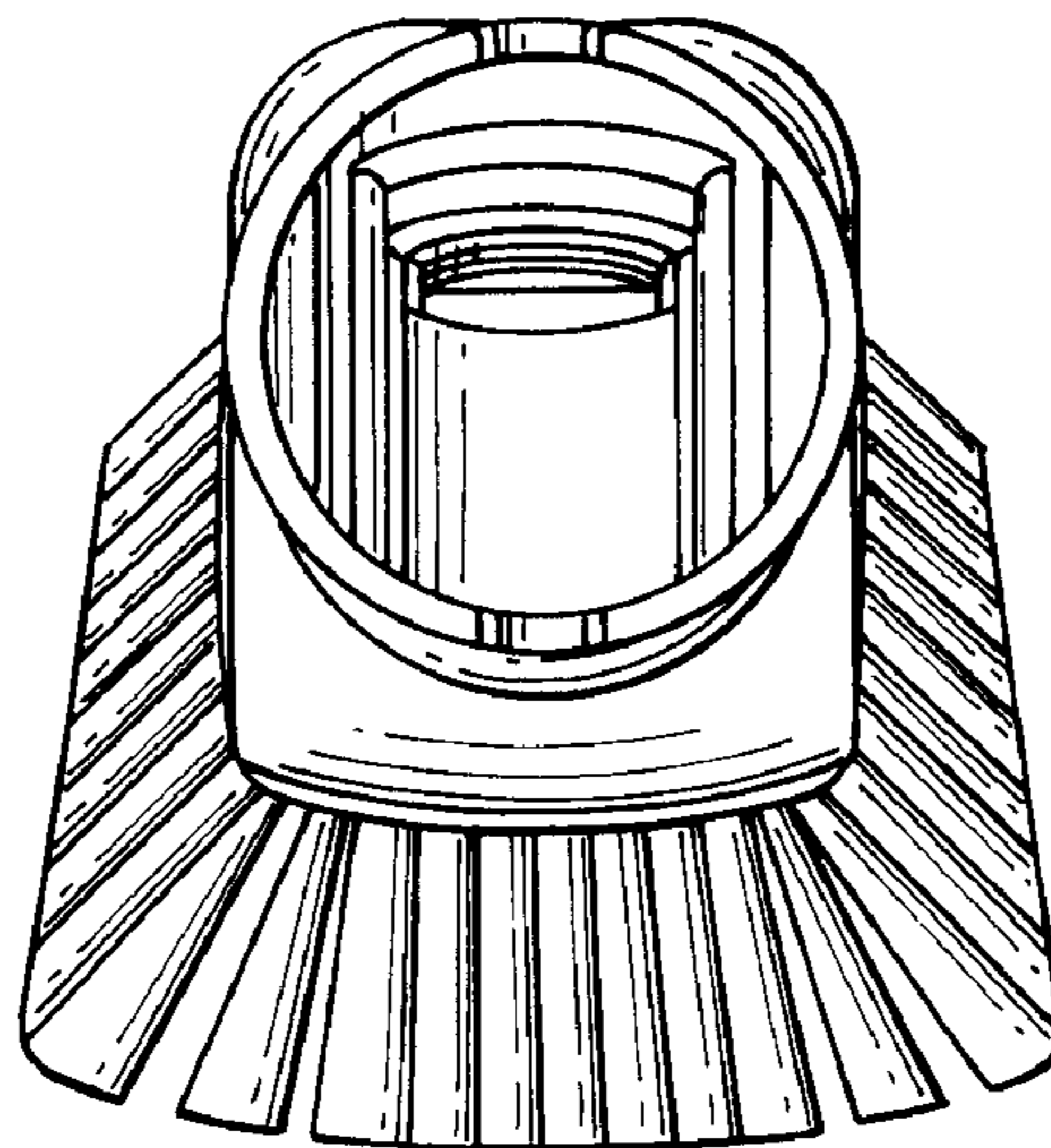

Fig. 6