

US00D520185S

(12) **United States Design Patent**  
**Zeng et al.**

(10) **Patent No.:** **US D520,185 S**

(45) **Date of Patent:** **\*\* May 2, 2006**

(54) **CAPSULE**

(75) Inventors: **Jenny Zheng Zeng**, Wolveterm (BE);  
**Frederique Hennebelle**,  
Bruxelle-Ixelles (BE); **Patrizio Ricci**,  
Grimbergen (BE); **Muriel Leila Gisele**  
**Cordier**, Brussels (BE); **Peter Robert**  
**Jozef Mayeur**, Kortrijk (BE); **Timothy**  
**Frederik Perry**, London (GB);  
**Dominic Burke**, London (GB)

(73) Assignee: **The Procter & Gamble Company**,  
Cincinnati, OH (US)

(\*\*) Term: **14 Years**

(21) Appl. No.: **29/223,984**

(22) Filed: **Feb. 23, 2005**

(30) **Foreign Application Priority Data**

Aug. 23, 2004 (EM) ..... 000218078

(51) **LOC (8) Cl.** ..... **28-03**

(52) **U.S. Cl.** ..... **D28/8.1; D9/416; D24/101**

(58) **Field of Classification Search** ..... 510/194,  
510/220, 221, 224, 225, 294, 439-442, 447-449;  
D28/8.1, 8.2; D9/416; D24/101-103

See application file for complete search history.

(56) **References Cited**

U.S. PATENT DOCUMENTS

D407,640 S	*	4/1999	Nelson et al.	.....	D9/416
D431,863 S	*	10/2000	Richardson	.....	D24/104
D445,673 S	*	7/2001	Richardson	.....	D9/416
D445,674 S	*	7/2001	Pritchett	.....	D9/416
D493,105 S	*	7/2004	Childs et al.	.....	D9/416

\* cited by examiner

*Primary Examiner*—Jennifer Rivard

(74) *Attorney, Agent, or Firm*—David V. Upite

(57) **CLAIM**

The ornamental design for a capsule, as shown and described.

**DESCRIPTION**

FIG. 1 is a perspective view of a capsule;  
FIG. 2 is a back view thereof;  
FIG. 3 is a left side view thereof;  
FIG. 4 is a top elevational view thereof;  
FIG. 5 is a front view thereof;  
FIG. 6 is a right side view thereof; and,  
FIG. 7 is a bottom elevational view thereof.

**1 Claim, 3 Drawing Sheets**

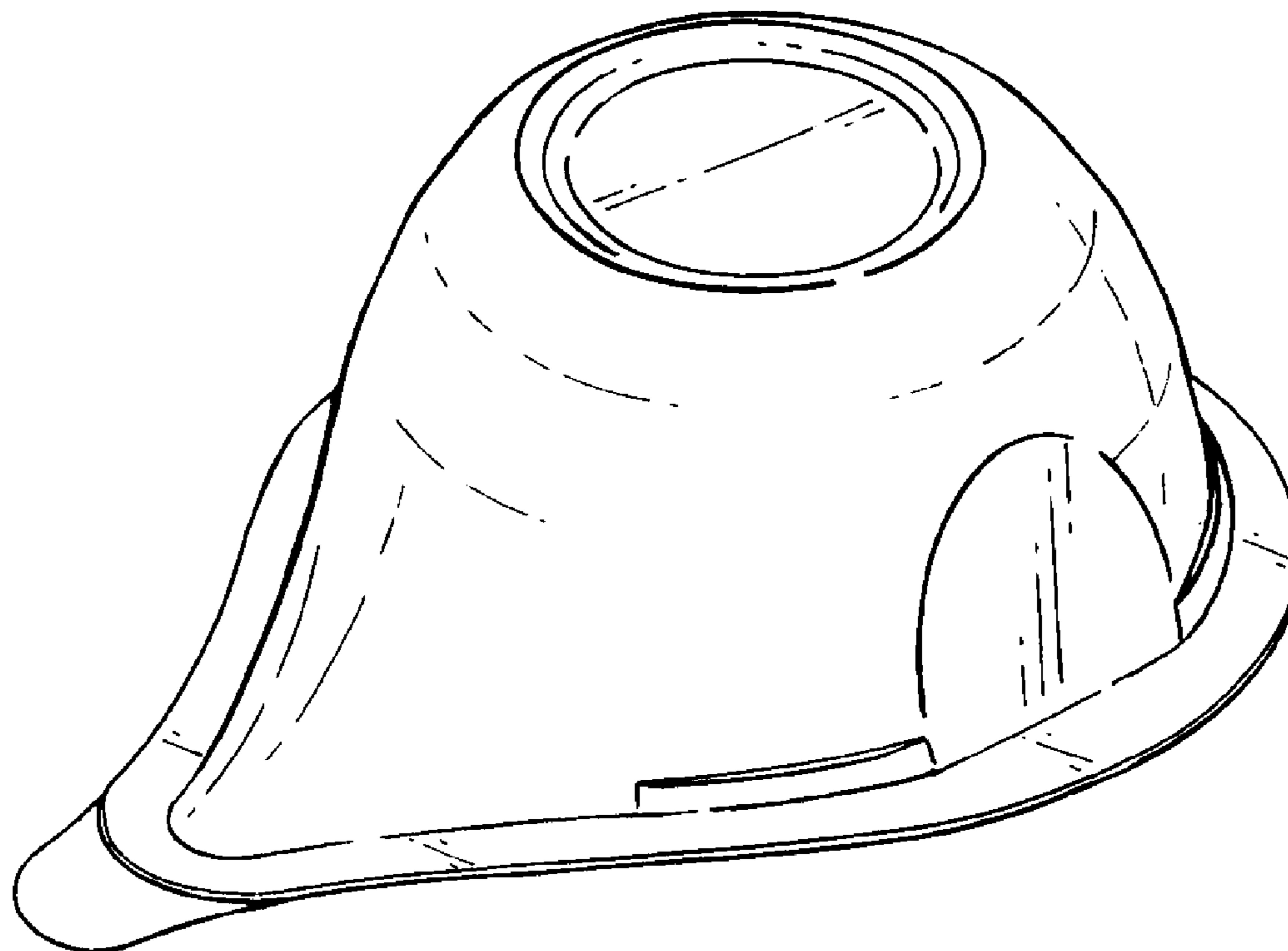

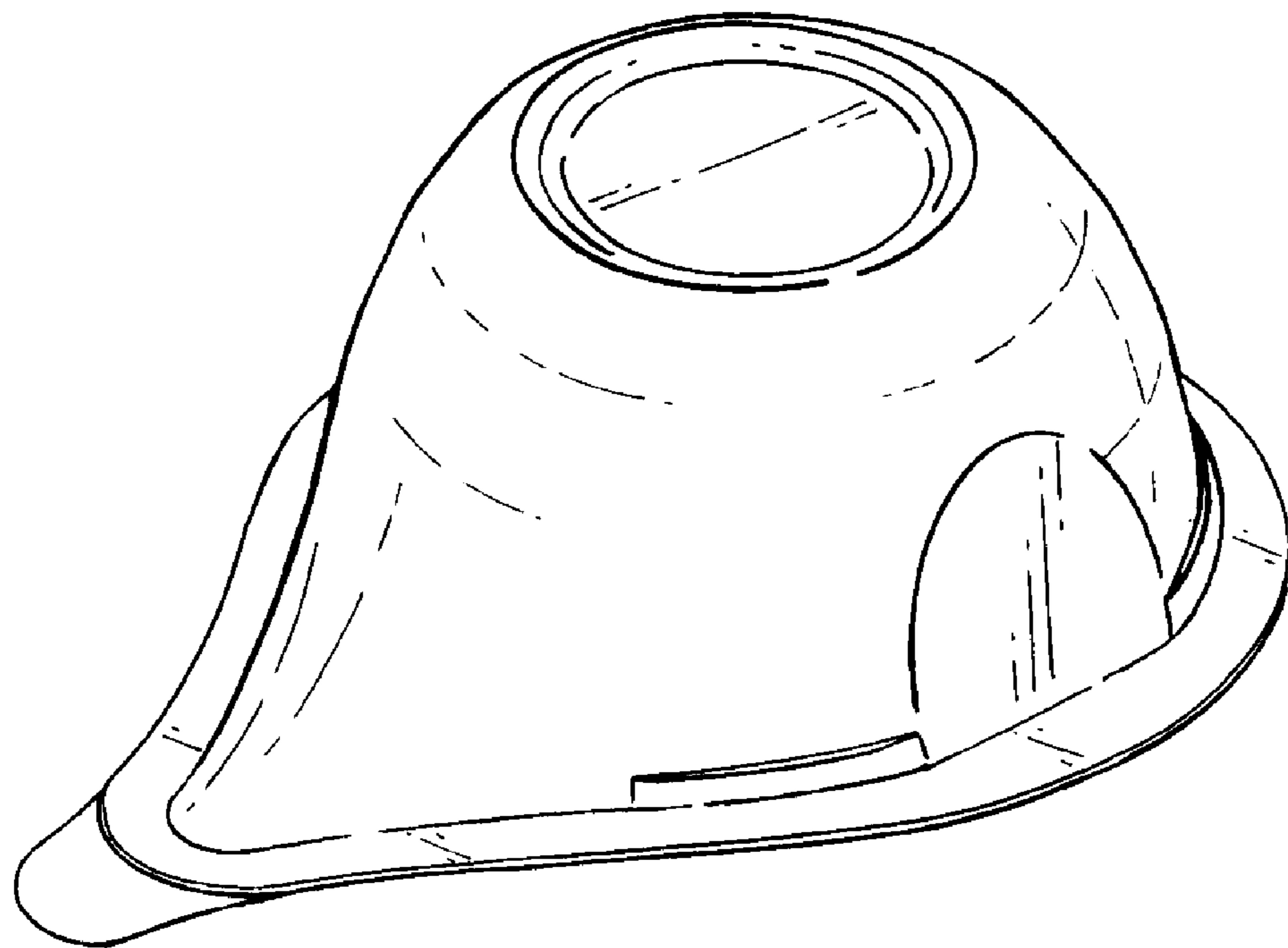

Fig. 1.

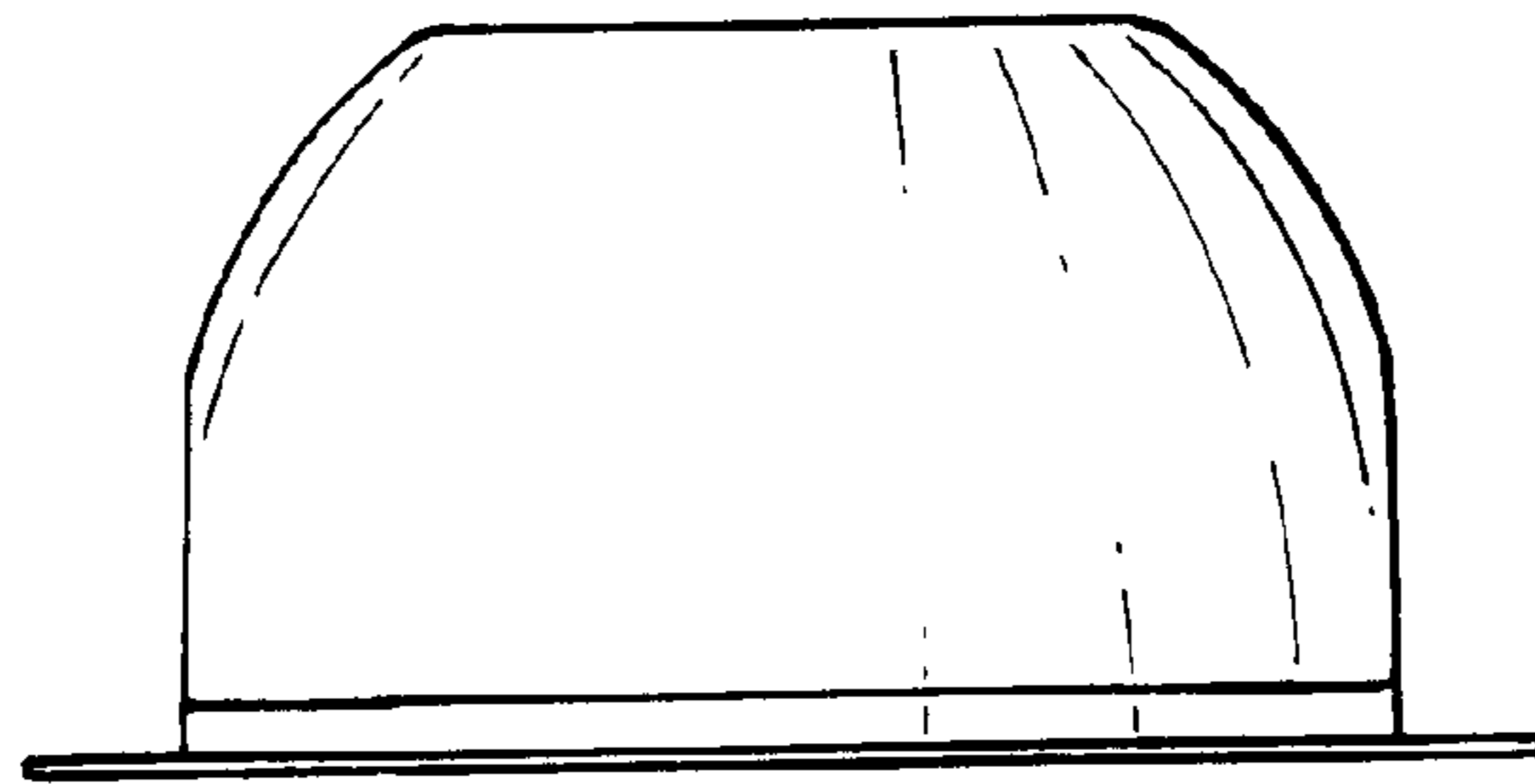

Fig.2.

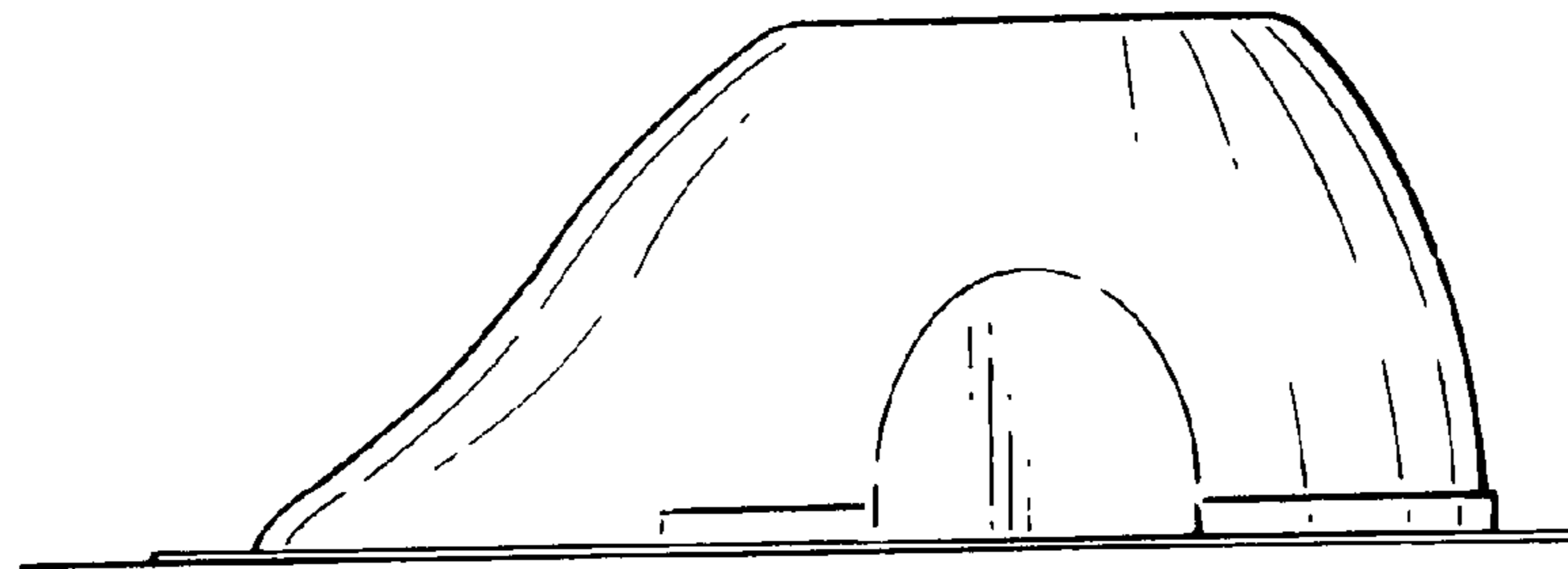

Fig.3.

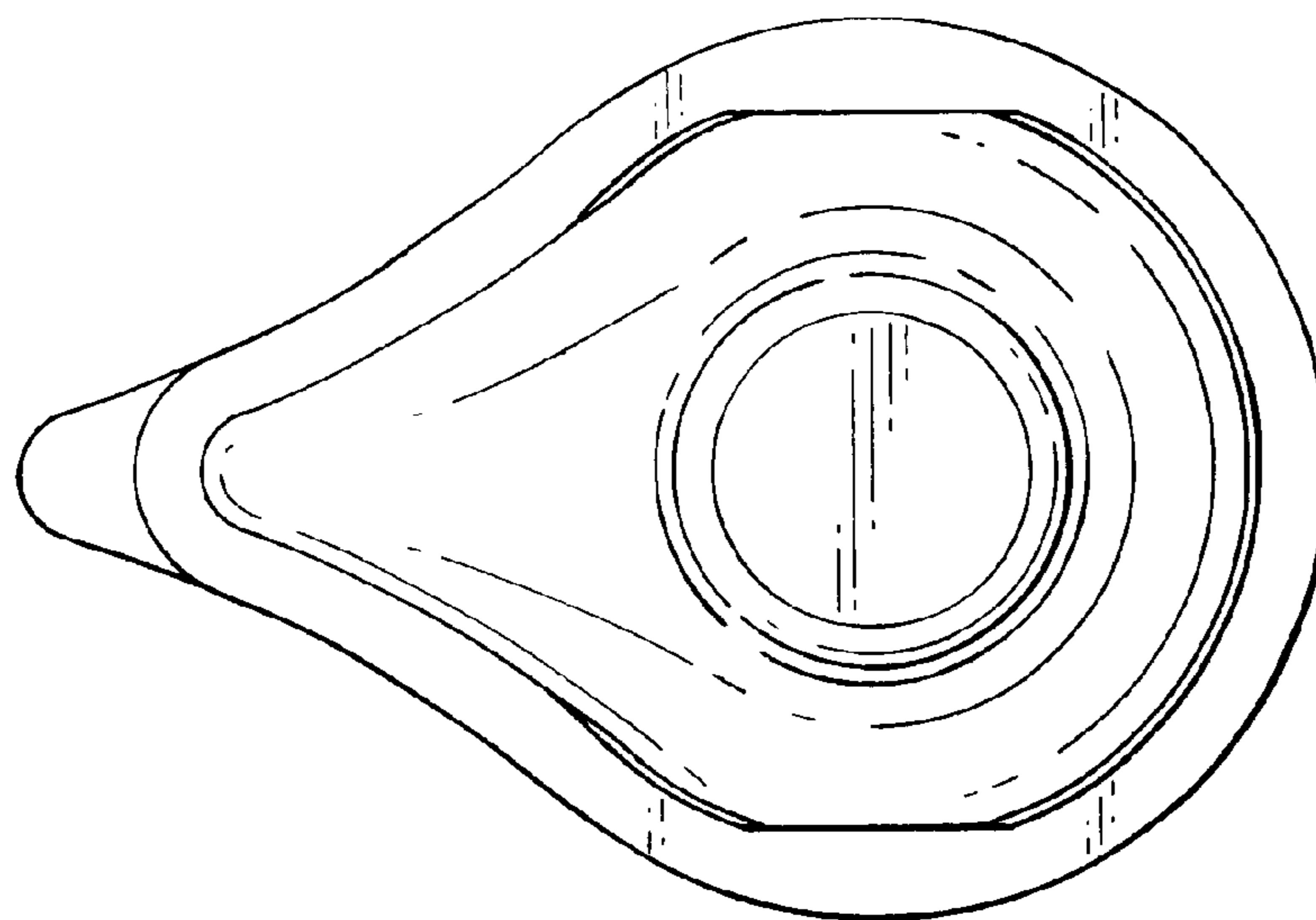

Fig.4.

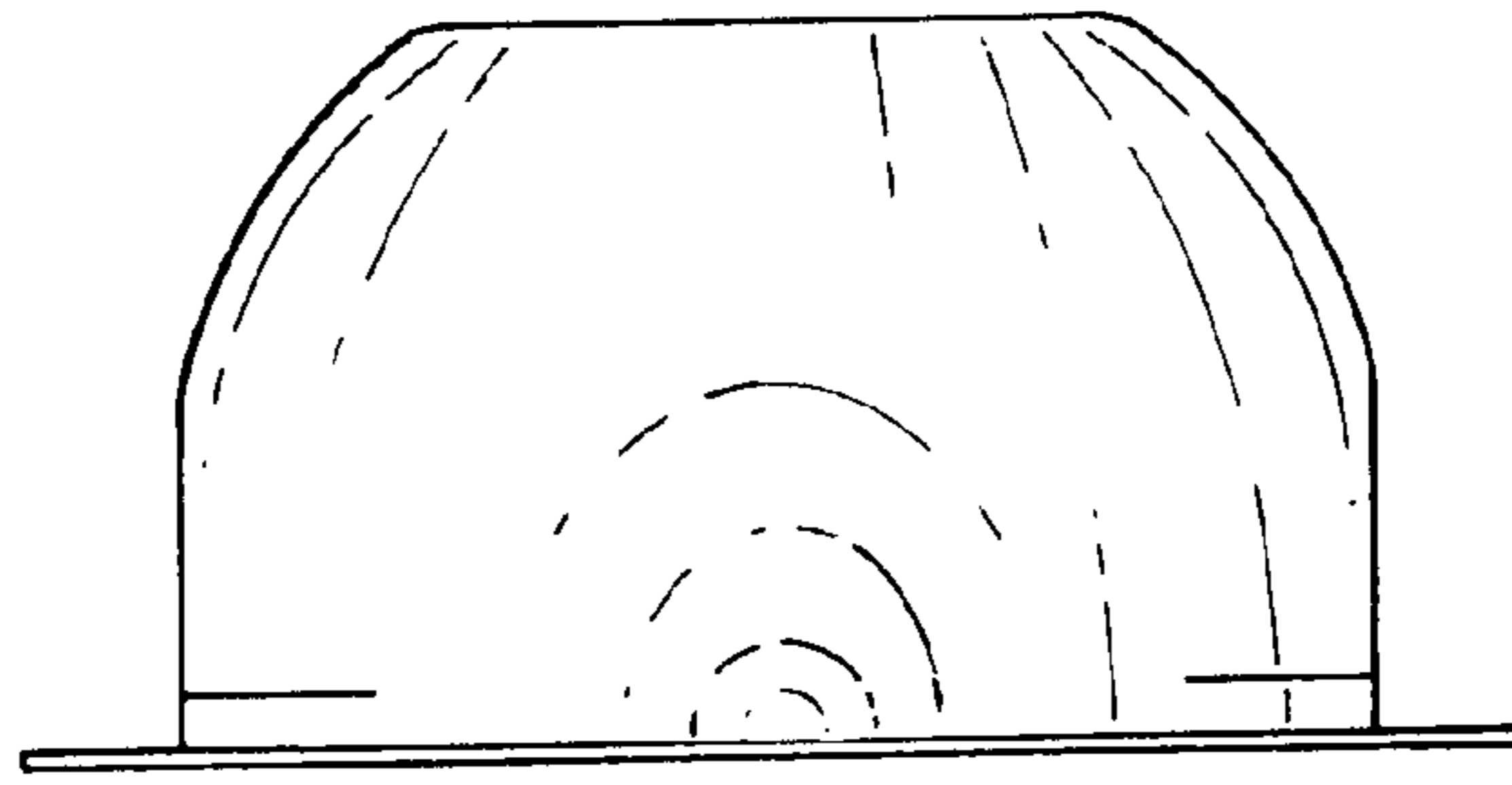

Fig.5.

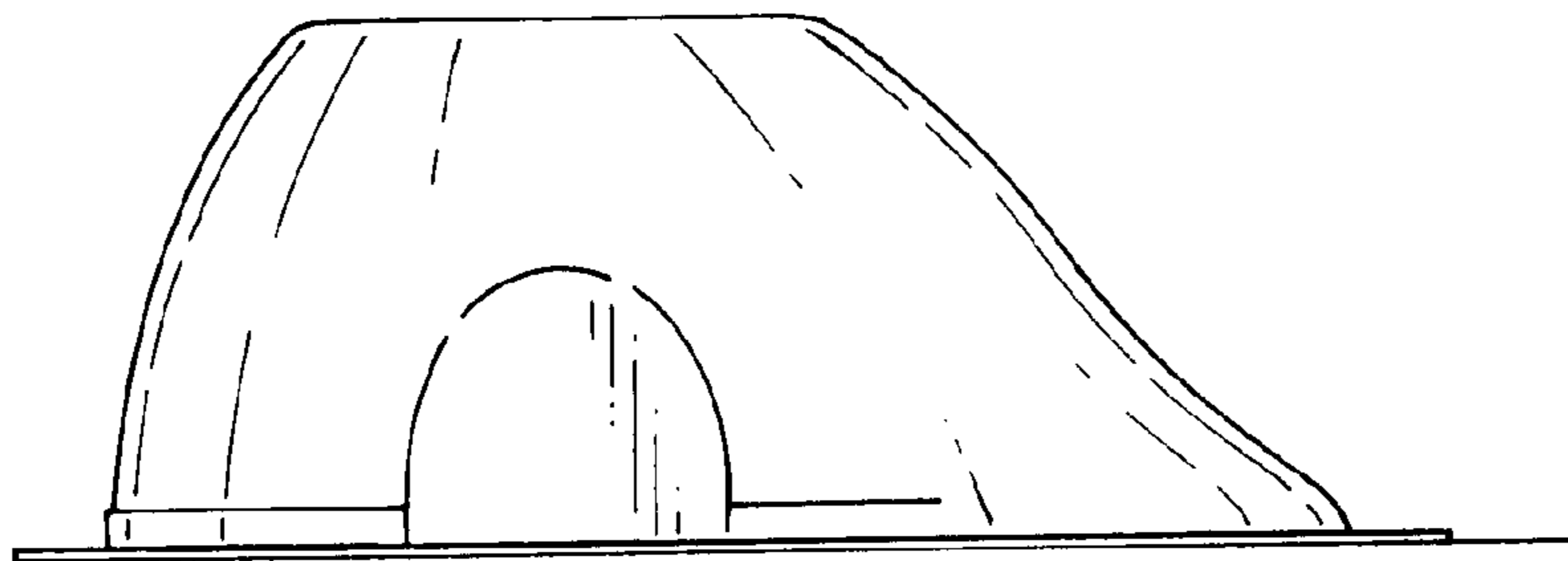

Fig.6.

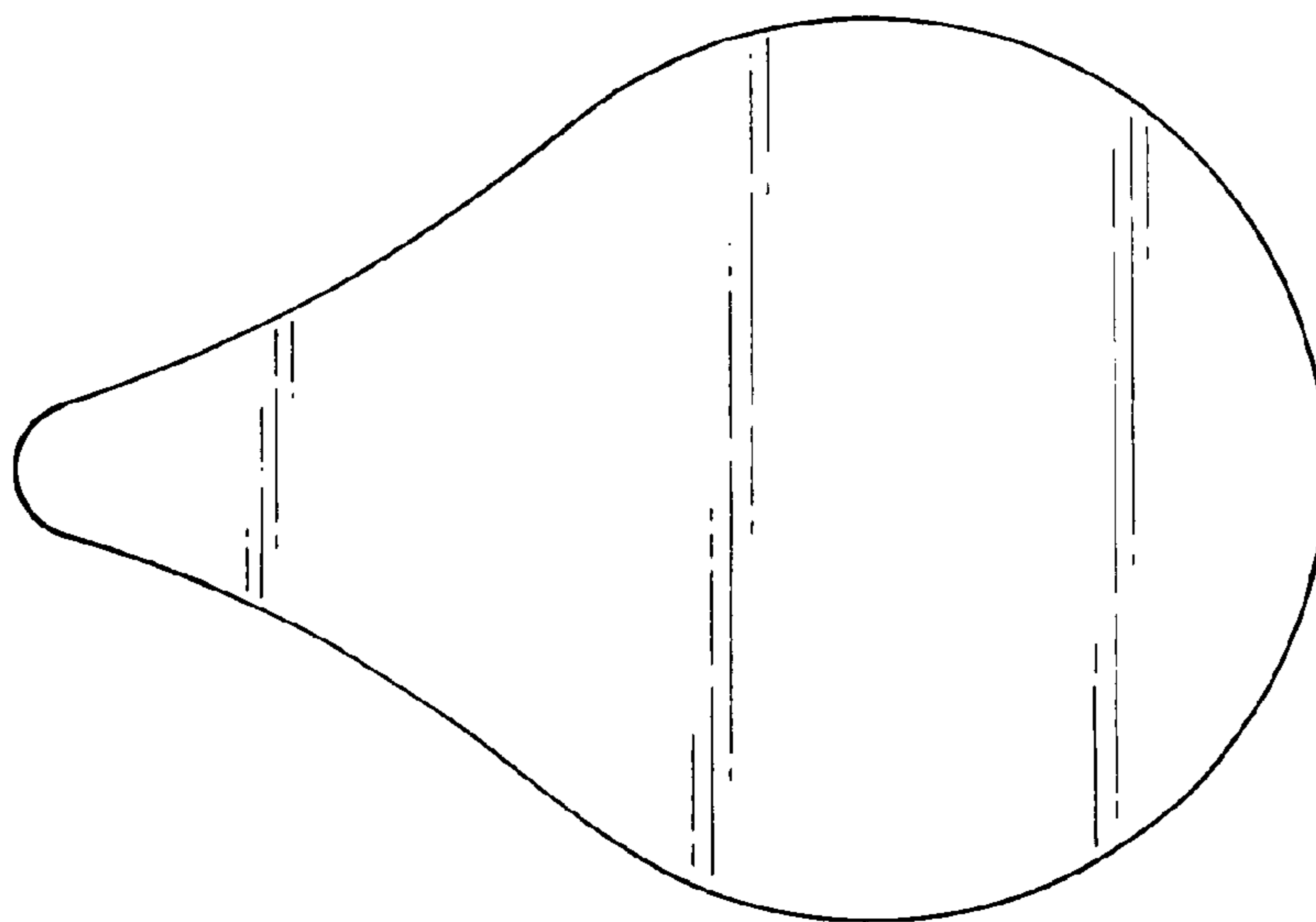

Fig.7.