



US00D520166S

(12) **United States Design Patent**
Galli

(10) **Patent No.:** **US D520,166 S**
(45) **Date of Patent:** **** May 2, 2006**

(54) **VENTED FLASHLIGHT**

DESCRIPTION

(76) Inventor: **Robert D. Galli**, 135 Circuit Dr., North Kingstown, RI (US) 02852

(**) Term: **14 Years**

(21) Appl. No.: **29/221,089**

(22) Filed: **Jan. 11, 2005**

(51) **LOC (8) Cl.** **26-02**

(52) **U.S. Cl.** **D26/49**

(58) **Field of Classification Search** D26/37-50;
362/157, 158, 171-174, 183-208
See application file for complete search history.

(56) **References Cited**

U.S. PATENT DOCUMENTS

D426,332 S	*	6/2000	Young	D26/49
D495,078 S	*	8/2004	Galli	D26/49
D496,481 S	*	9/2004	Wiesmeth	D26/49
D504,970 S	*	5/2005	Dalton et al.	D26/49

* cited by examiner

Primary Examiner—Marcus A. Jackson

(74) *Attorney, Agent, or Firm*—Barlow, Josephs & Holmes, Ltd.

(57) **CLAIM**

The ornamental design for a vented flashlight, as shown and described.

FIG. 1 is a perspective view showing my new design for a vented flashlight;

FIG. 2 is a front end view thereof;

FIG. 3 is a back end view thereof;

FIG. 4 is a right side view thereof;

FIG. 5 is a left side view thereof;

FIG. 6 is a bottom view thereof;

FIG. 7 is a top view thereof;

FIG. 8 is a perspective view showing a first alternate embodiment of my new design for a vented flashlight;

FIG. 9 is a front end view thereof;

FIG. 10 is a back end view thereof;

FIG. 11 is a right side view thereof;

FIG. 12 is a left side view thereof;

FIG. 13 is a bottom view thereof;

FIG. 14 is a top view thereof;

FIG. 15 is a perspective view showing a second alternate embodiment of my new design for a vented flashlight;

FIG. 16 is a front end view thereof;

FIG. 17 is a back end view thereof;

FIG. 18 is a right side view thereof;

FIG. 19 is a left side view thereof;

FIG. 20 is a bottom view thereof; and,

FIG. 21 is a top view thereof.

The cap and switch portions depicted in broken lines in FIGS. 8 through 21 have been shown for illustrative purposes only and form no part of the claimed design.

1 Claim, 21 Drawing Sheets

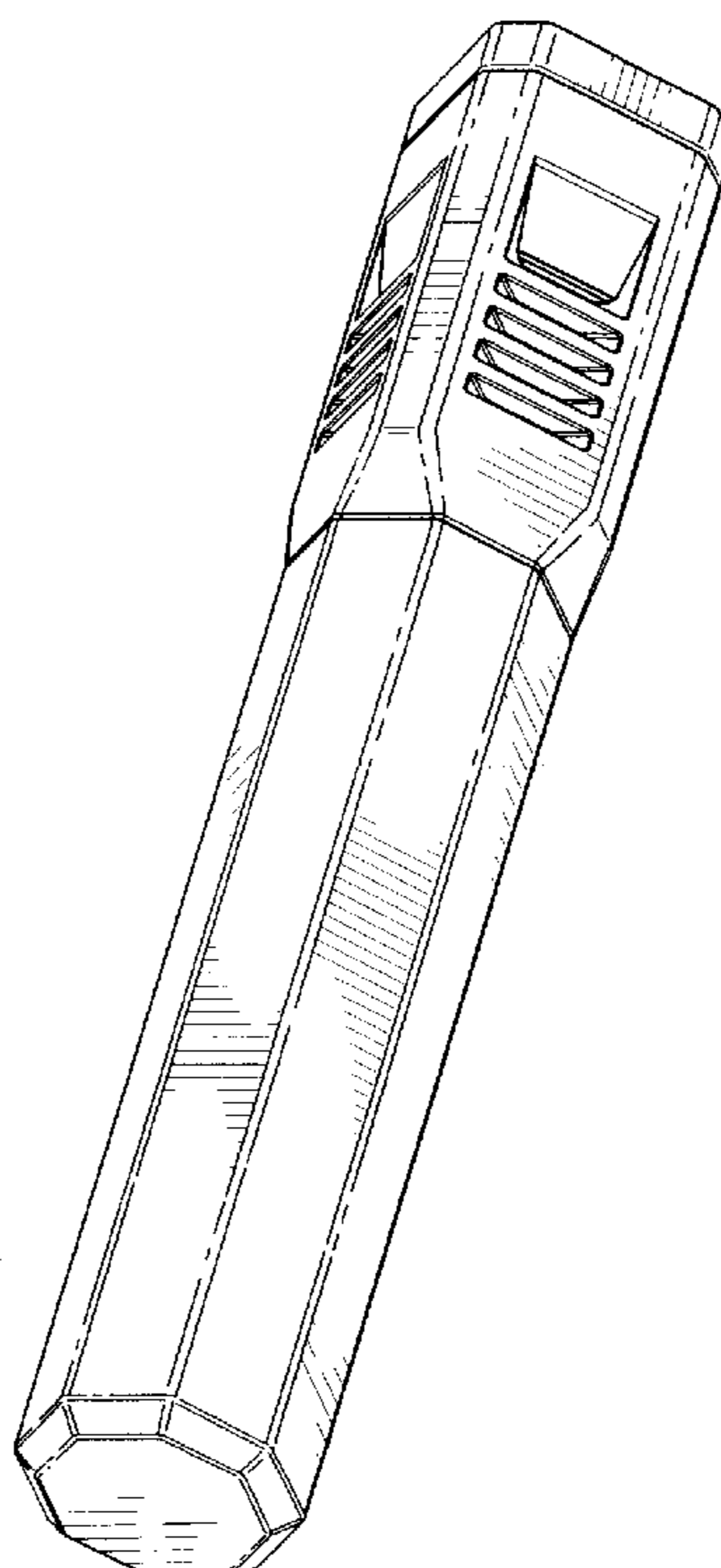

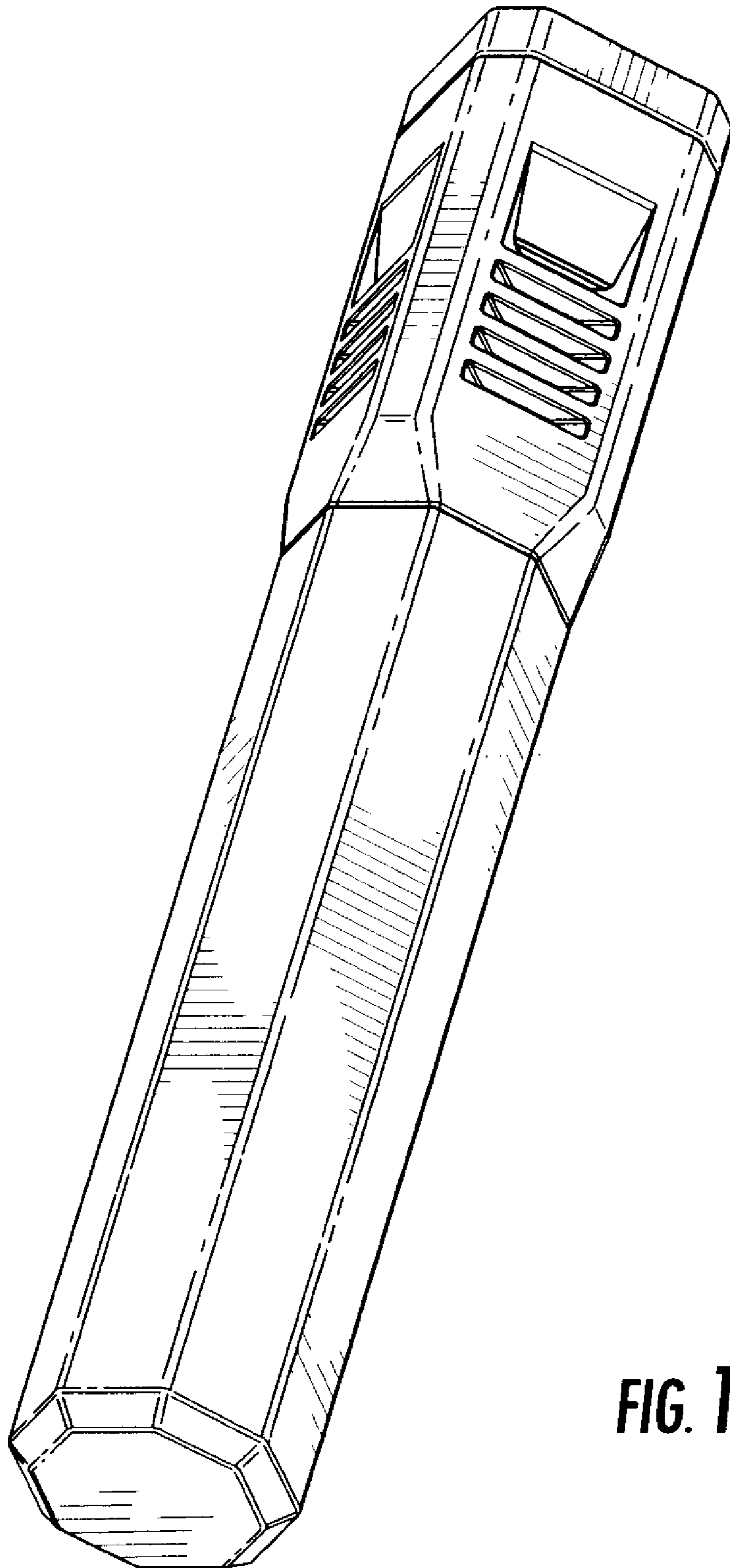

FIG. 1

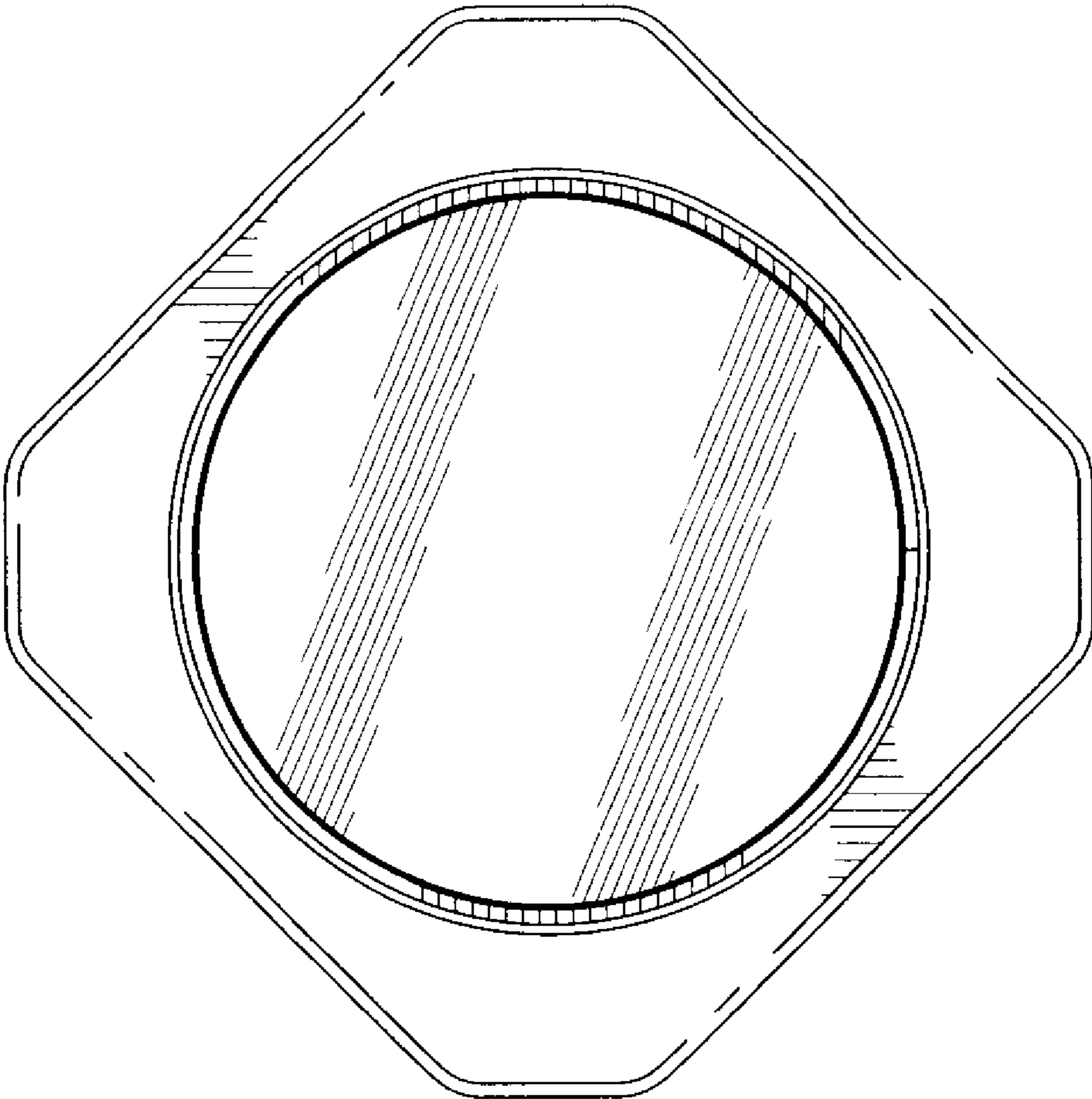

FIG. 2

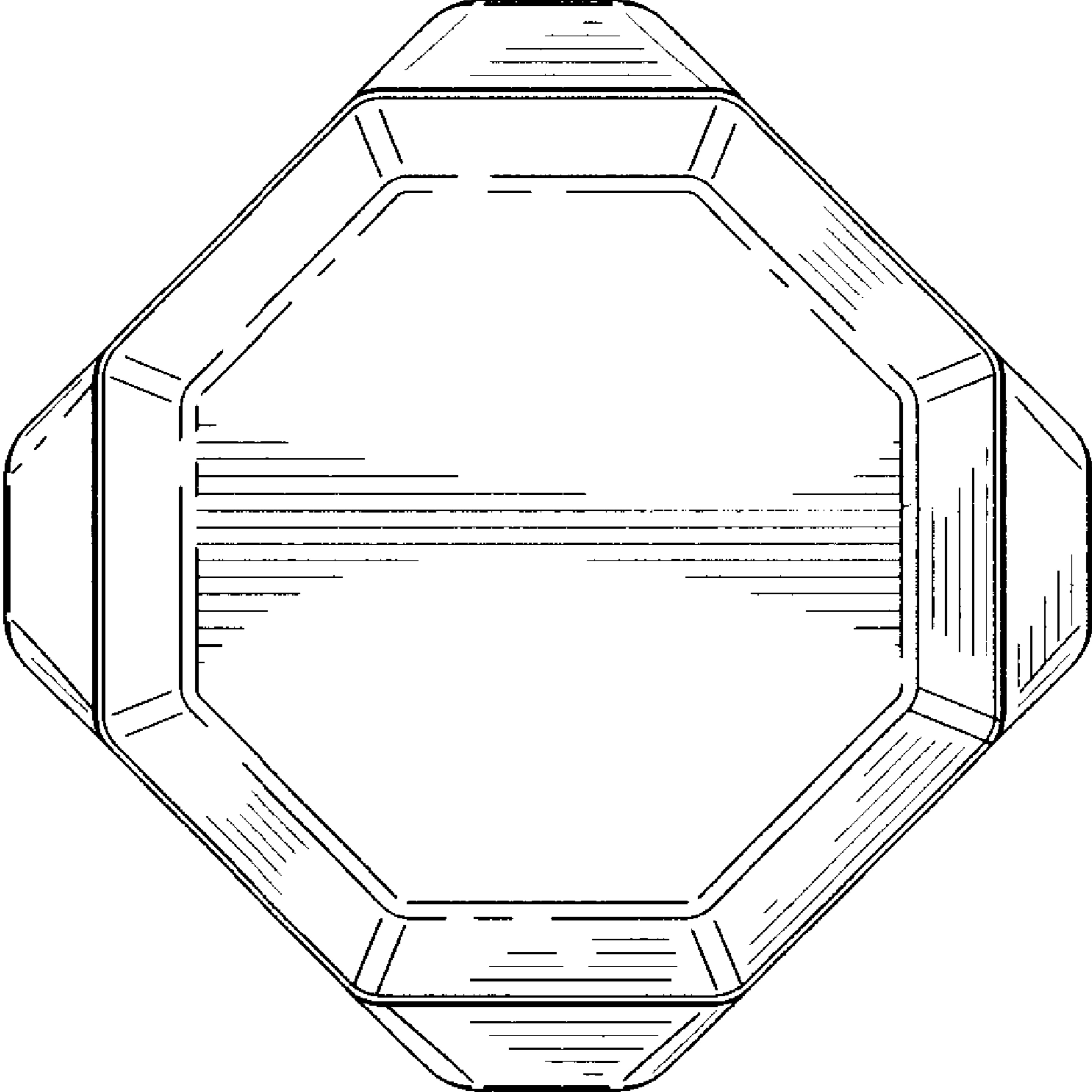

FIG. 3

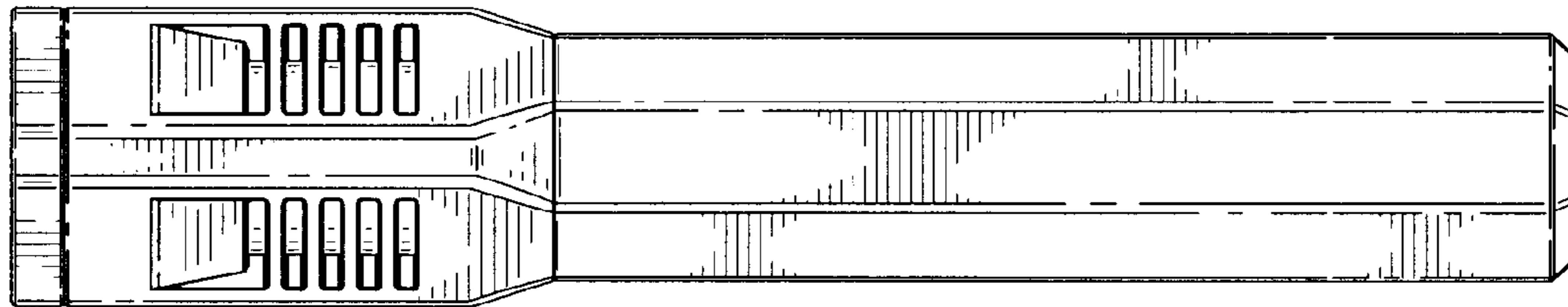

FIG. 4

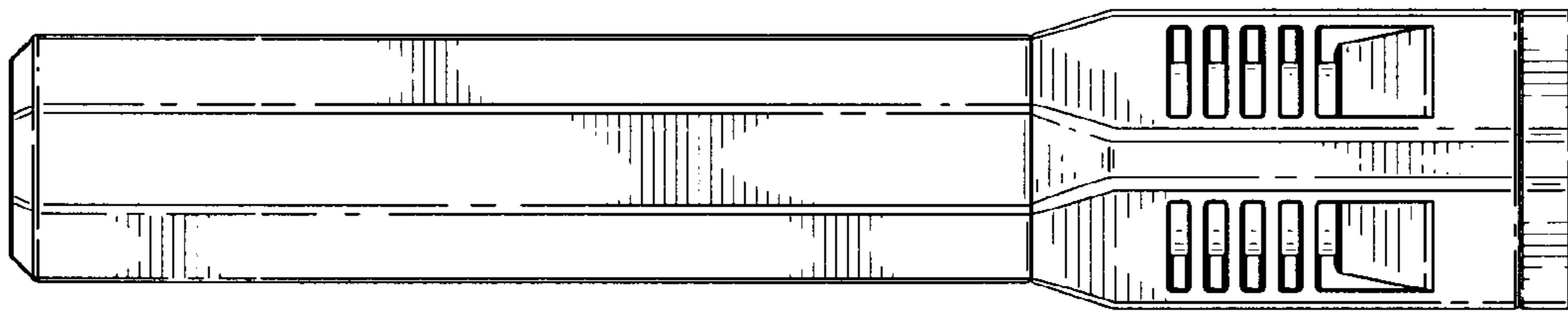

FIG. 5

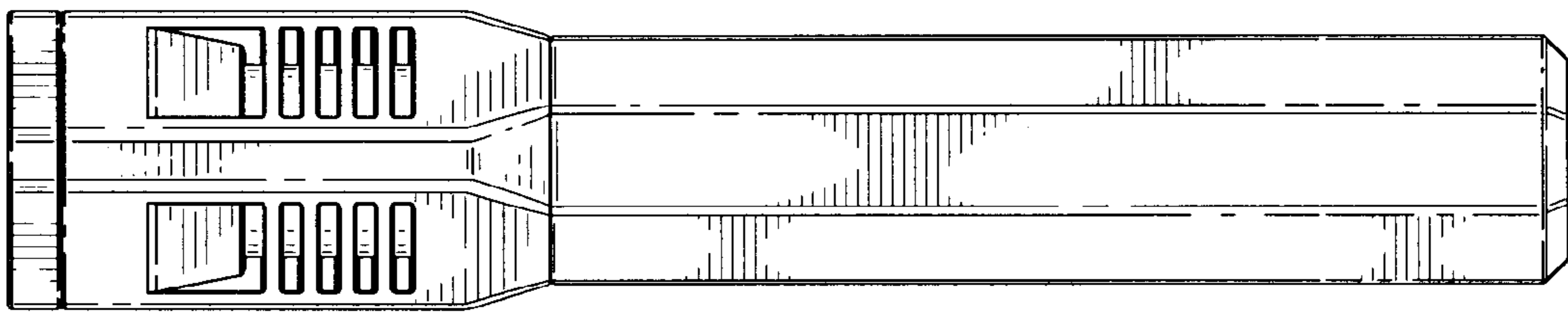

FIG. 6

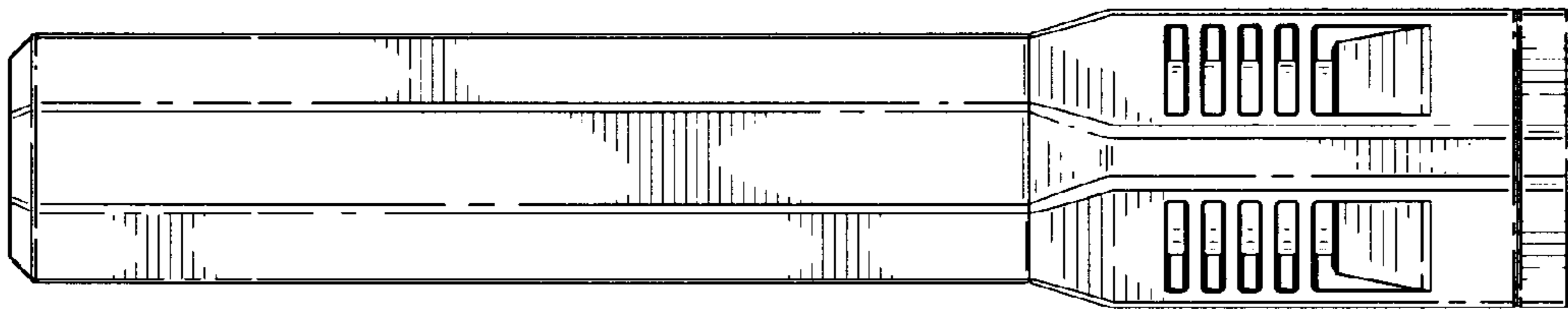

FIG. 7

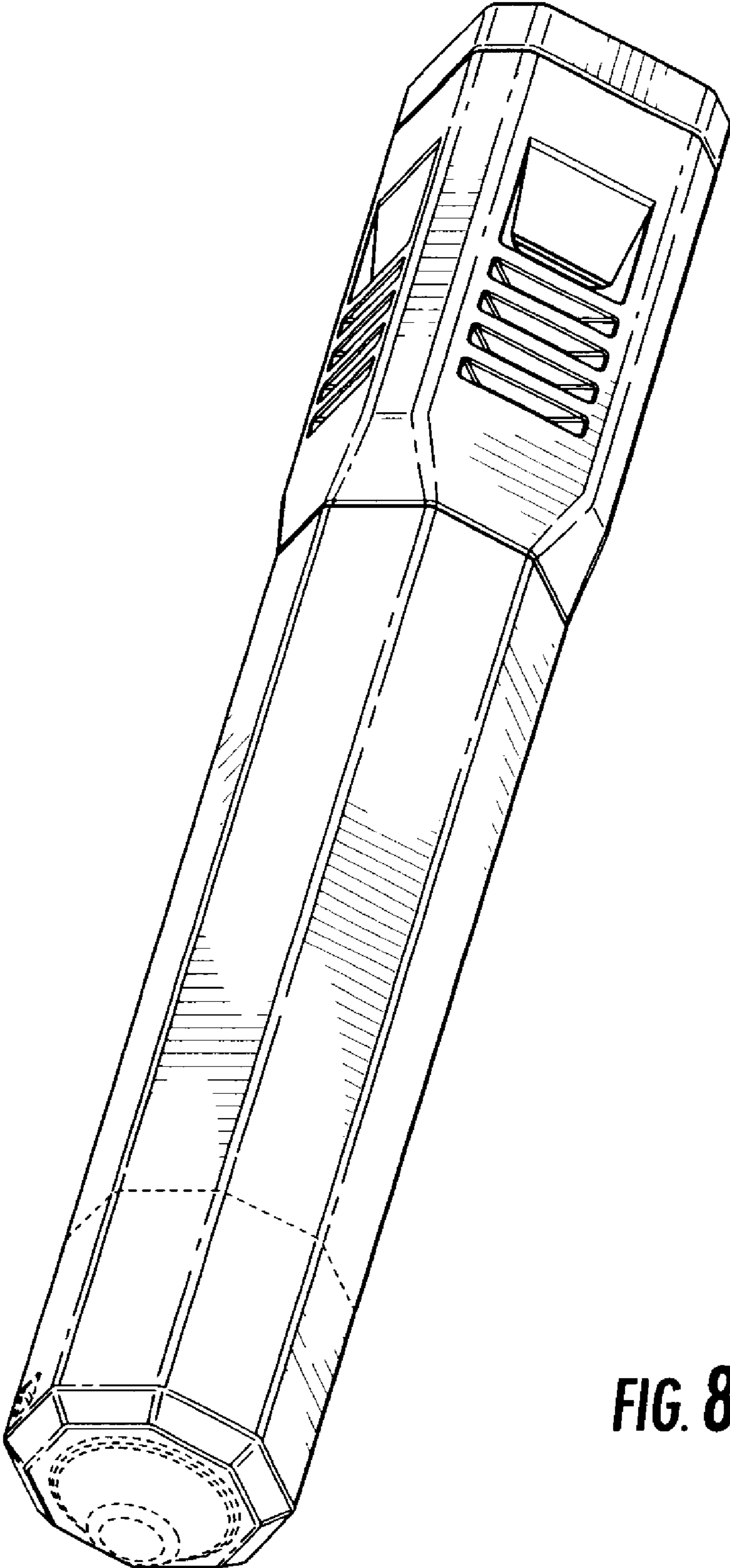

FIG. 8

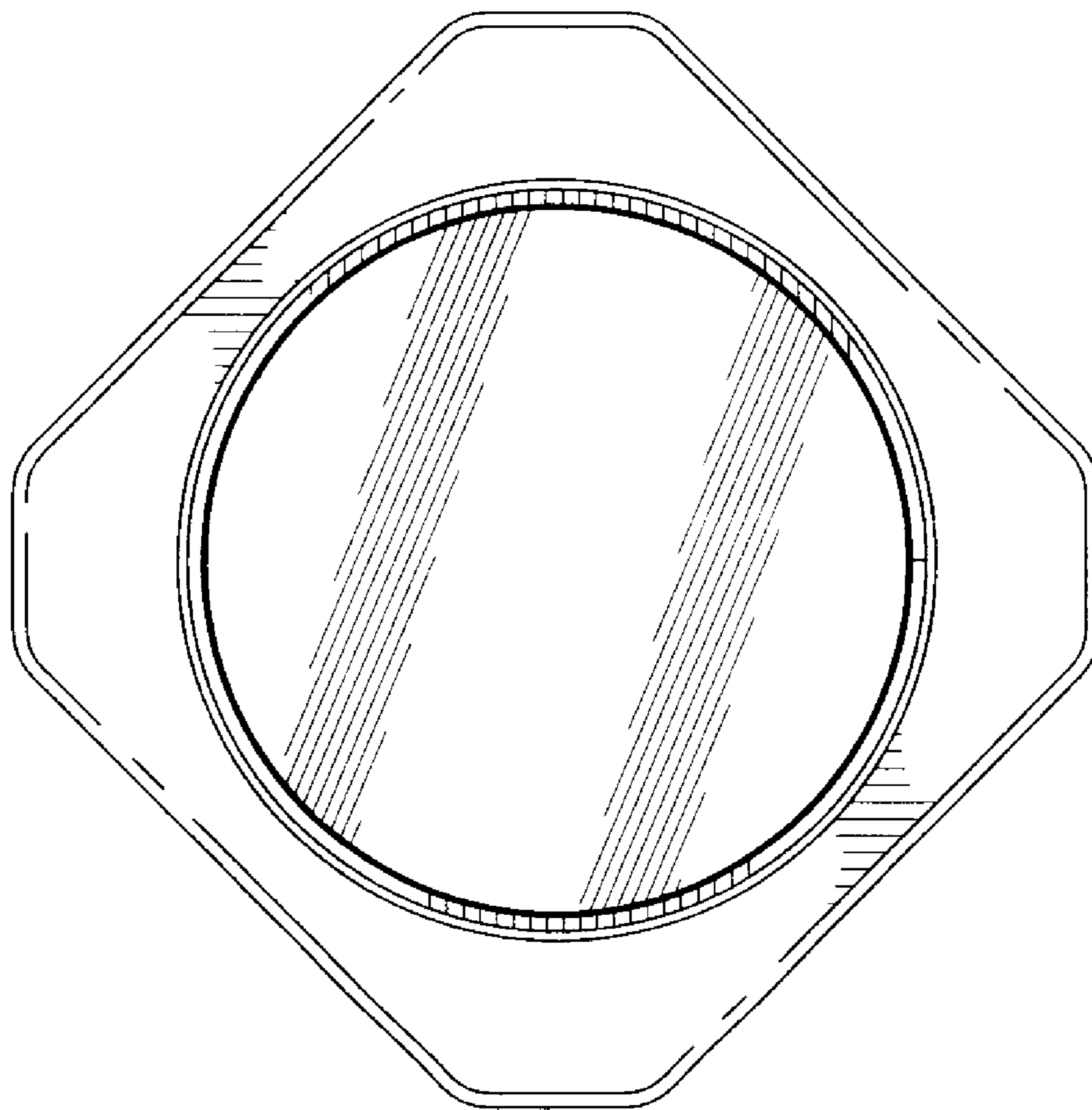

FIG. 9

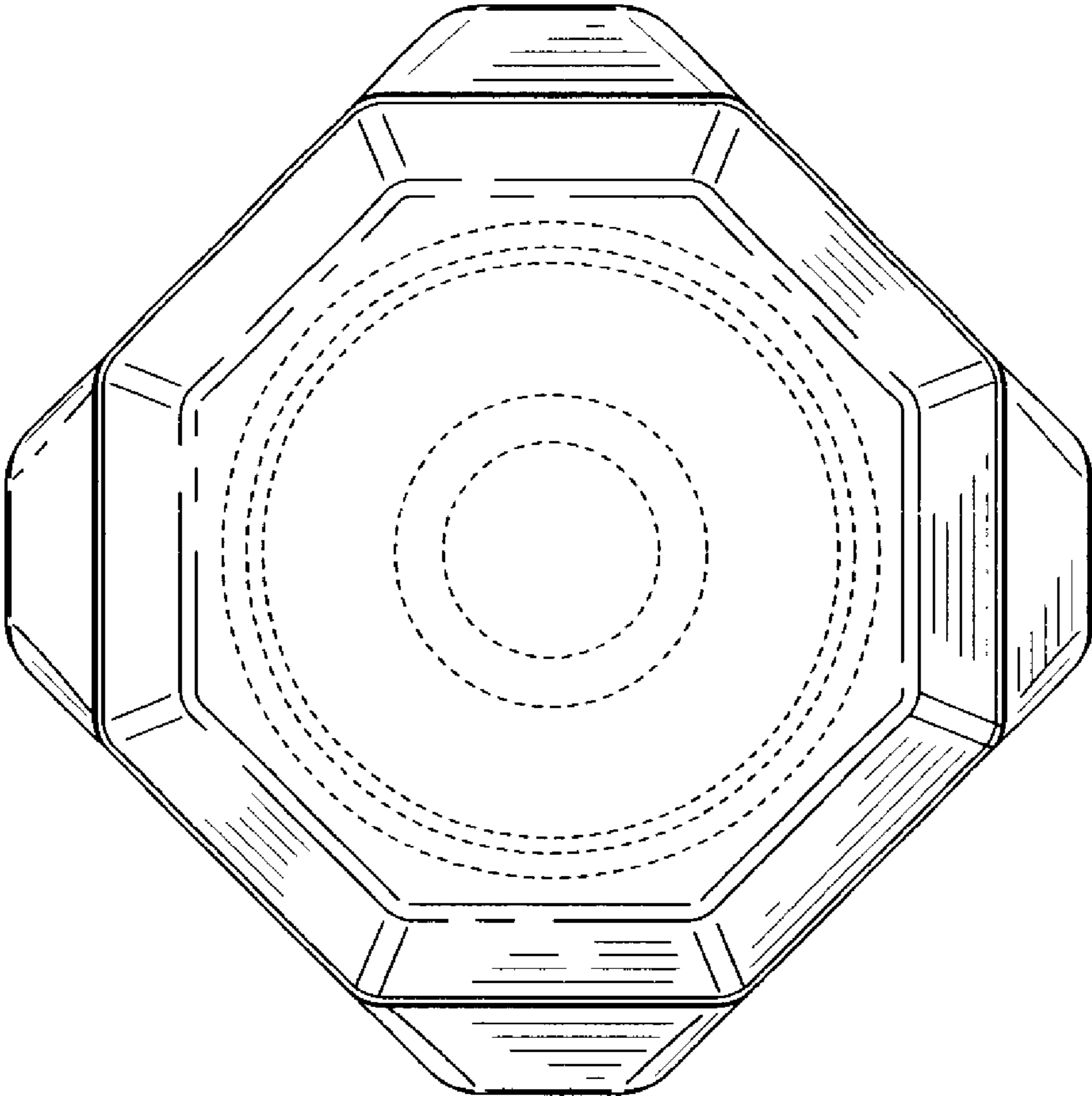

FIG. 10

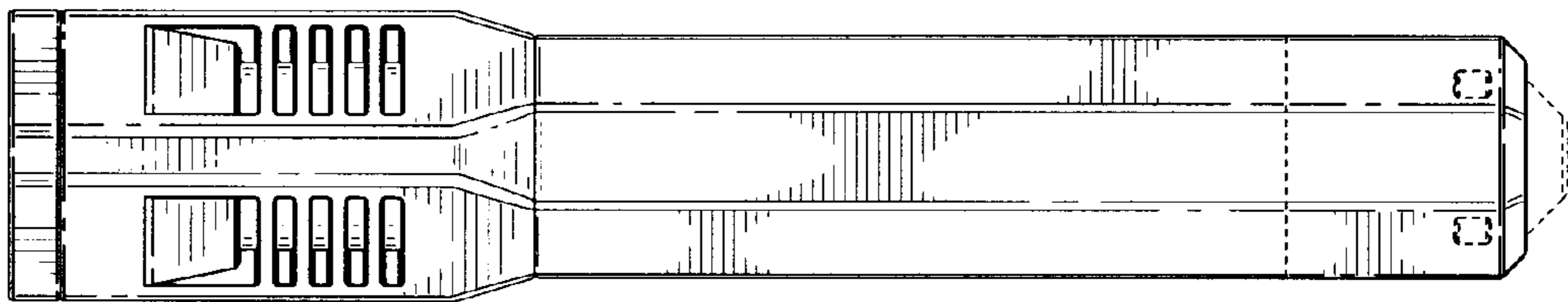

FIG. 11

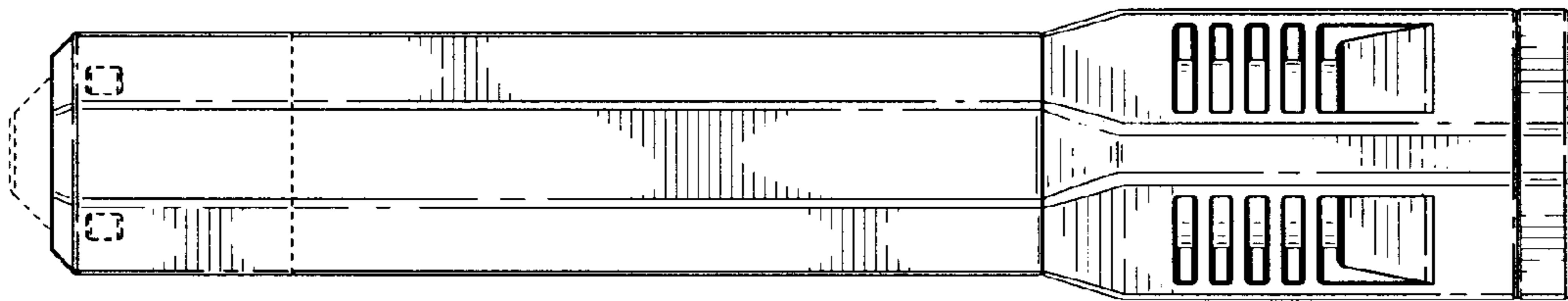

FIG. 12

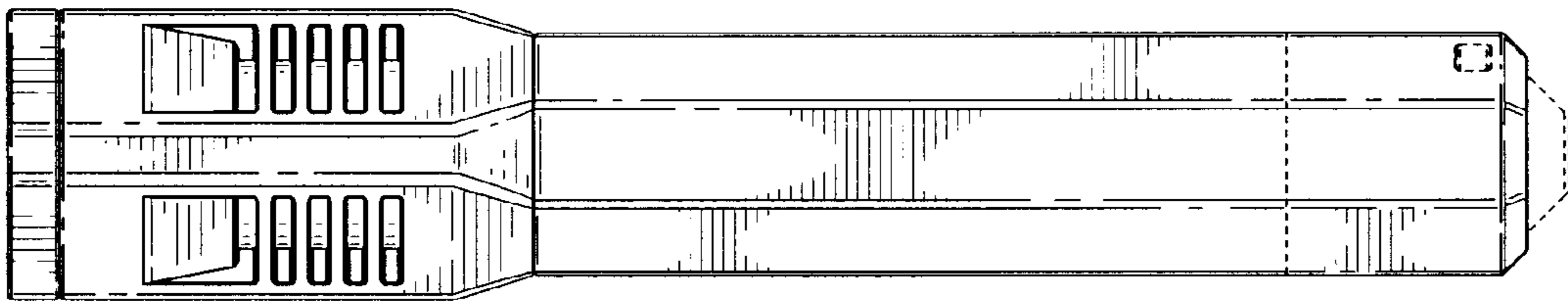

FIG. 13

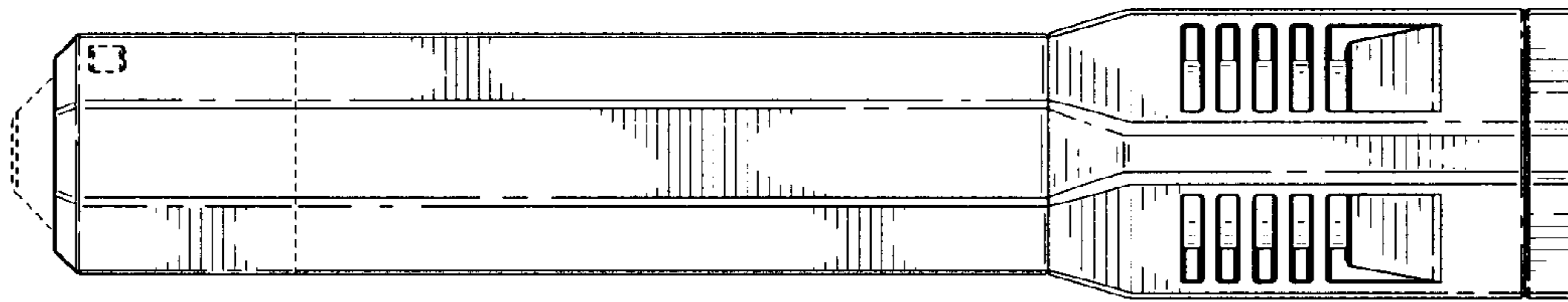

FIG. 14

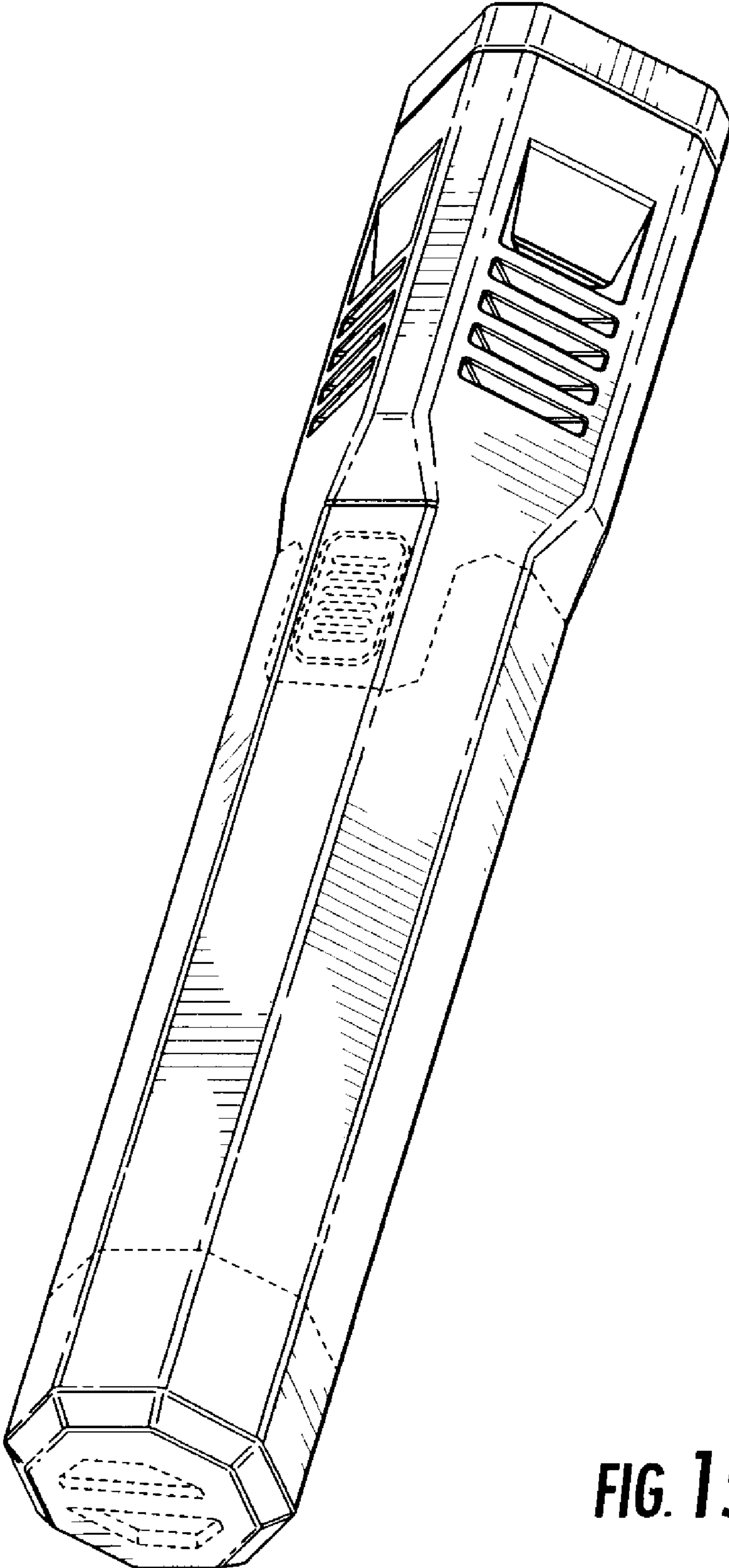

FIG. 15

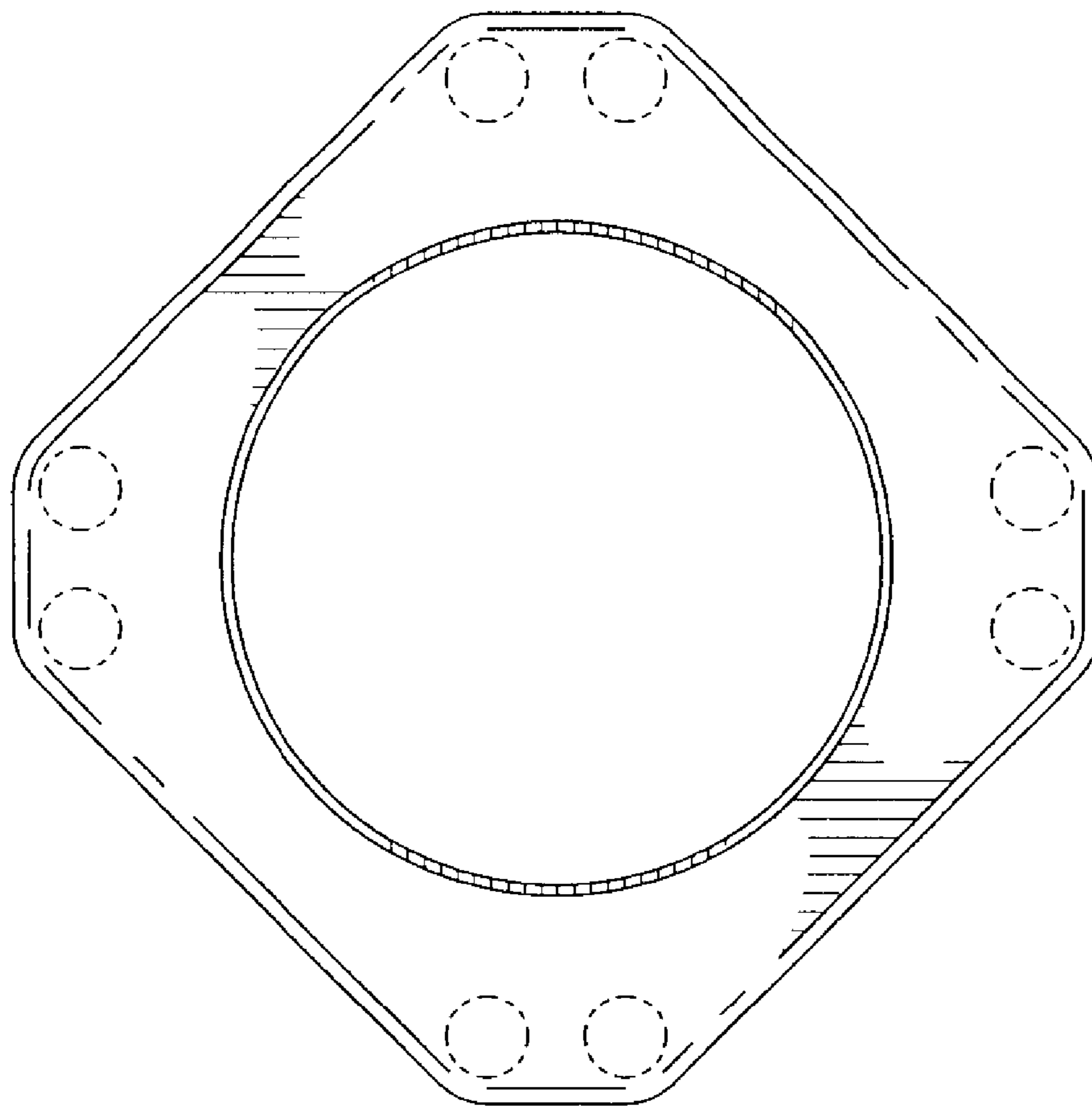

FIG. 16

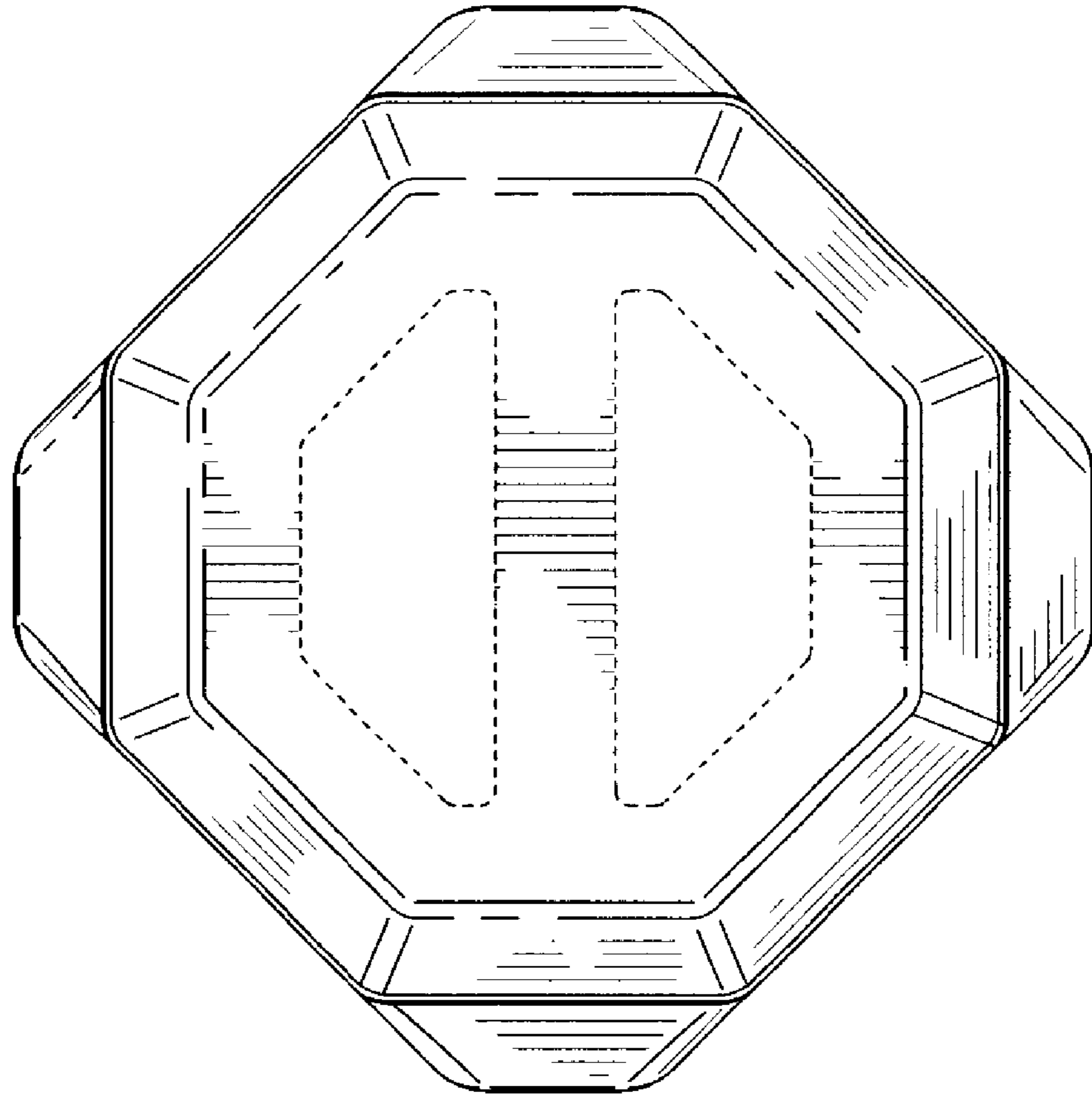

FIG. 17

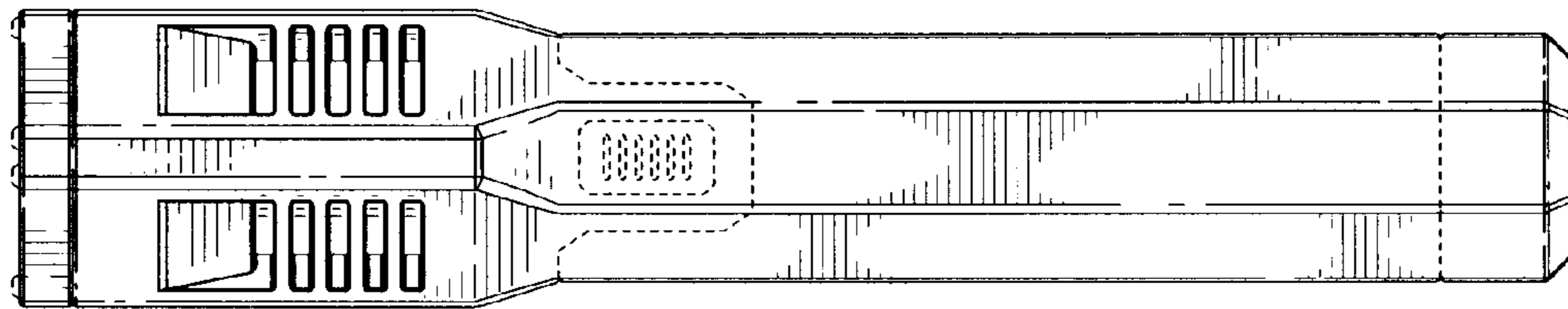

FIG. 18

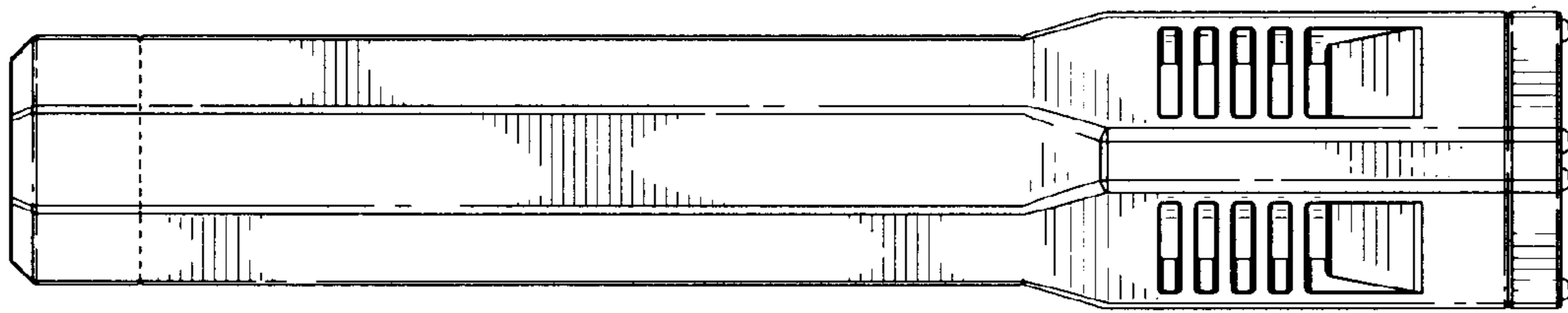

FIG. 19

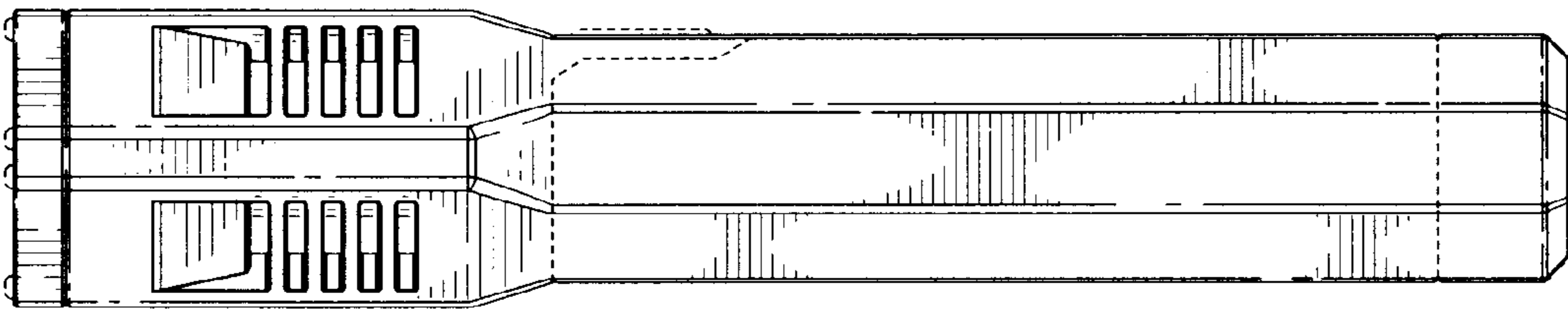

FIG. 20

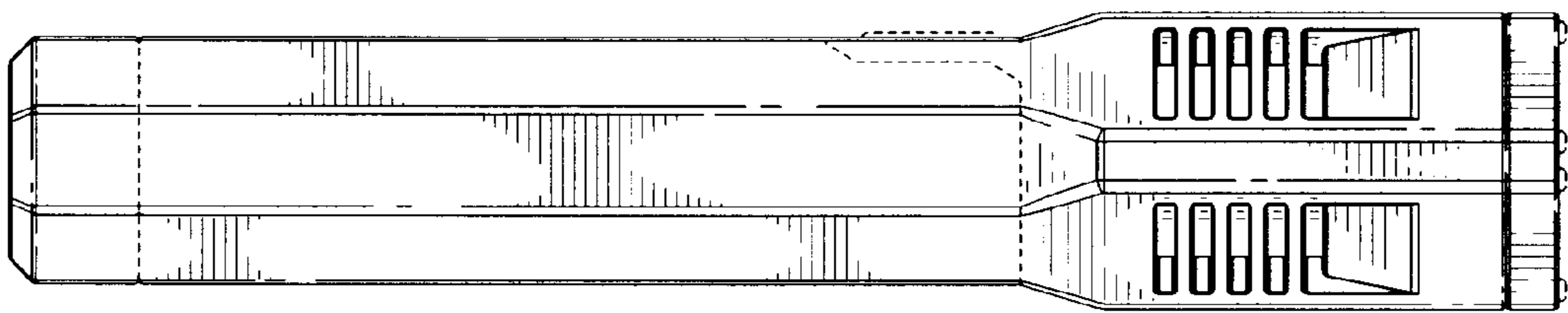

FIG. 21